

Philips LCD Monitor Electronic User's Manual

Home

safety and
troubleshooting

about this
manual

product
information

installing your
monitor

on-screen
display

customer care
and warranty

glossary

download
& print

LCD Monitor **220CW9**

Register your product and get support at
www.philips.com/welcome



Safety Precautions and
Maintenance

FAQs

Troubleshooting

Regulatory Information

Other Related Information

Safety and Troubleshooting Information

Safety precautions and maintenance



WARNING: Use of controls, adjustments or procedures other than those specified in this documentation may result in exposure to shock, electrical hazards and/or mechanical hazards.

Read and follow these instructions when connecting and using your computer monitor:

Operation:

- Keep the monitor out of direct sunlight and away from stoves or any other heat source.
- Remove any object that could fall into ventilation holes or prevent proper cooling of the monitor's electronics.
- Do not block the ventilation holes on the cabinet.
- When positioning the monitor, make sure the power plug and outlet are easily accessible.
- If turning off the monitor by detaching the power cable or DC power cord, wait for 6 seconds before attaching the power cable or DC power cord for normal operation.
- Please use approved power cord provided by Philips all the time. If your power cord is missing, please contact with your local service center. (Please refer to Customer Care Consumer Information Center)
- Do not subject the LCD monitor to severe vibration or high impact conditions during operation.
- Do not knock or drop the monitor during operation or transportation.

Maintenance:

- To protect your display from possible damage, do not put excessive pressure on the LCD panel. When moving your monitor, grasp the frame to lift; do not lift the monitor by placing your hand or fingers on the LCD panel.
- Unplug the monitor if you are not going to use it for an extensive period of time.
- Unplug the monitor if you need to clean it with a slightly damp cloth. The screen may be wiped with a dry cloth when the power is off. However, never use organic solvent, such as, alcohol, or ammonia-based liquids to clean your monitor.
- To avoid the risk of shock or permanent damage to the set, do not expose the monitor to dust, rain, water, or excessive moisture environment.
- If your monitor gets wet, wipe it with dry cloth as soon as possible.
- If foreign substance or water gets in your monitor, please turn the power off immediately and disconnect the power cord. Then, remove the foreign substance or water, and send it to the maintenance center.

- Do not store or use the LCD monitor in locations exposed to heat, direct sunlight or extreme cold.
- In order to maintain the best performance of your monitor and use it for a longer lifetime, please use the monitor in a location that falls within the following temperature and humidity ranges.
 - Temperature: 0-40°C 32-95°F
 - Humidity: 20-80% RH

IMPORTANT: Always activate a moving screen saver program when you leave your monitor unattended. Always activate a periodic screen refresh application if your LCD monitor will display unchanging static content. Uninterrupted display of still or static images over an extended period may cause “burn in”, also known as “after-imaging” or “ghost imaging”, on your screen. “Burn-in”, “after-imaging”, or “ghost imaging” is a well-known phenomenon in LCD panel technology. In most cases, the “burned in” or “after-imaging” or “ghost imaging” will disappear gradually over a period of time after the power has been switched off.

WARNING: Severe “burn-in” or “after-image” or “ghost image” symptoms will not disappear and cannot be repaired. The damage mentioned above is not covered under your warranty.

Service:

- The casing cover should be opened only by qualified service personnel.
- If there is any need for any document for repair or integration, please contact with your local service center. (please refer to the chapter of "Consumer Information Center")
- For transportation information, please refer to "Physical Specifications".
- Do not leave your monitor in a car/trunk under direct sun light.



Consult a service technician if the monitor does not operate normally, or you are not sure what procedure to take when the operating instructions given in this manual have been followed.

[RETURN TO TOP OF THE PAGE](#)

[Safety and Troubleshooting](#)[General FAQs](#)[Screen Adjustments](#)[Compatibility with Other Peripherals](#)[LCD Panel Technology](#)[Ergonomics, Ecology and Safety Standards](#)[Troubleshooting](#)[Regulatory Information](#)[Other Related Information](#)

FAQs (Frequently Asked Questions)

General FAQs

Q: When I install my monitor what should I do if the screen shows 'Cannot display this video mode'?

A: Recommended video mode for Philips 22": 1680x1050 @60Hz.

1. Unplug all cables, then connect your PC to the monitor that you used previously.
 2. In the Windows Start Menu, select Settings/Control Panel. In the Control Panel Window, select the Display icon. Inside the Display Control Panel, select the 'Settings' tab. Under the setting tab, in box labeled 'desktop area', move the sidebar to 1680x1050 pixels (22").
 3. Open 'Advanced Properties' and set the Refresh Rate to 60Hz, then click OK.
 4. Restart your computer and repeat step 2 and 3 to verify that your PC is set at 1680x1050@60Hz (22").
 5. Shut down your computer, disconnect your old monitor and reconnect your Philips LCD monitor.
 6. Turn on your monitor and then turn on your PC.
-

Q: What are the .inf and .icm files on the CD-ROM? How do I install the drivers (.inf and .icm)?

A: These are the driver files for your monitor. Follow the instructions in your user manual to install the drivers. Your computer may ask you for monitor drivers (.inf and .icm files) or a driver disk when you first install your monitor. Follow the instructions to insert the (companion CD-ROM) included in this package. Monitor drivers (.inf and .icm files) will be installed automatically.

Q: How do I adjust the resolution?

A: Your video card/graphic driver and monitor together determine the available resolutions. You can select the desired resolution under Windows® Control Panel with the "Display properties".

Q: What if I get lost when I am making monitor adjustments?

A: Simply press the Menu button, the Setup button, then select 'Reset' to recall all of the original factory settings.

Q: What is the Auto function?

A: The *AUTO adjustment* key restores the optimal screen position, phase and clock settings by pressing of a single button – without the need to navigate through OSD (On Screen Display) menus and control keys.

Note: Auto function is available in selected models only.

Q: My Monitor has no power (Power LED does not light up). What should I do?

A: Make sure the AC power cord is connected between the monitor and AC outlet, and click a key on keyboard/mouse to wake up the PC.

Q: Will the LCD monitor accept an interlaced signal under PC models?

A: No. If an Interlace signal is used, the screen displays both odd and even horizontal scanning lines at the same time, thus distorting the picture.

Q: What does the Refresh Rate mean for LCD?

A: Unlike CRT display technology, in which the speed of the electron beam is swept from the top to the bottom of the screen determines flicker, an active matrix display uses an active element (TFT) to control each individual pixel and the refresh rate is therefore not really applicable to LCD technology.

Q: Will the LCD screen be resistant to scratches?

A: A protective coating is applied to the surface of the LCD, which is durable to a certain extent (approximately up to the hardness of a 2H pencil). In general, it is recommended that the panel surface is not subject to any excessive shocks or scratches.

Q: How should I clean the LCD surface?

A: For normal cleaning, use a clean, soft cloth. For extensive cleaning, please use isopropyl alcohol. Do not use other solvents such as ethyl alcohol, ethanol, acetone, hexane, etc.

Q: Can I change the color setting of my monitor?

A: Yes, you can change your color setting through OSD control as the following procedures,

1. Press "Menu" to show the OSD (On Screen Display) menu
2. Press "Down Arrow" to select the option "Color" then press "OK" to enter color setting, there are three settings as below.

a. Color Temperature; The six settings are 5000K, 6500K, 7500K, 8200K, 9300K and 11500K. With settings in the 5000K range the panel appears 'warm,' with a red-white color tone, while a 11500K temperature yields 'cool, blue-white toning."

b. sRGB; this is a standard setting for ensuring correct exchange of colors between different device (e.g. digital cameras, monitors, printers, scanners, etc)

c. User Define; the user can choose his/her preference color setting by adjusting red, green blue color.

d. Gamma; The five settings are 1.8, 2.0, 2.2, 2.4, and 2.6.

*A measurement of the color of light radiated by an object while it is being heated. This measurement is expressed in terms of absolute scale, (degrees Kelvin). Lower Kevin temperatures such as 2004K are red; higher temperatures such as 9300K are blue. Neutral temperature is white, at 6504K.

[RETURN TO TOP OF THE PAGE](#)

Screen Adjustments

Q: When I install my monitor, how do I get the best performance from the monitor?

A: For best performance, make sure your display settings are set at 1680x1050@60Hz for 22".

Q: How do LCDs compare to CRTs in terms of radiation?

A: Because LCDs do not use an electron gun, they do not generate the same amount of radiation at the screen surface.

[RETURN TO TOP OF THE PAGE](#)

Compatibility with other Peripherals

Q: Can I connect my LCD monitor to any PC, workstation or Mac?

A: Yes. All Philips LCD monitors are fully compatible with standard PCs, Macs and workstations. You may need a cable adapter to connect the monitor to your Mac system. Please contact your Philips sales representative for more information.

Q: Are Philips LCD monitors Plug-and-Play?

A: Yes, the monitors are Plug-and-Play compatible with Windows® 95, 98, 2000, XP and Vista.

Q: What is USB (Universal Serial Bus)?

A: Think of USB as a smart plug for PC peripherals. USB automatically determines resources (like driver software and bus bandwidth) required by peripherals. USB makes necessary resources available without user intervention. There are three main

benefits of USB. USB eliminates "case anxiety," the fear of removing the computer case to install circuit board cards -- that often requires adjustment of complicated IRQ settings -- for add-on peripherals. USB does away with "port gridlock." Without USB, PCs are normally limited to one printer, two Com port devices (usually a mouse and modem), one Enhanced Parallel Port add-on (scanner or video camera, for example), and a joystick. More and more peripherals for multimedia computers come on the market every day. With USB, up to 127 devices can run simultaneously on one computer. USB permits "hot plug-in." No need to shut down, plug in, reboot and run set up to install peripherals. No need to go through the reverse process to unplug a device. Bottom line: USB transforms today's "Plug-and-Pray" into true Plug-and-Play!

Please refer to glossary for more information about USB.

Q: What is a USB hub ?

A: A USB hub provides additional connections to the Universal Serial Bus. A hub's upstream port connects a hub to the host, usually a PC. Multiple downstream ports in a hub allows connection to another hub or device, such as a USB keyboard, camera or printer.

[RETURN TO TOP OF THE PAGE](#)

LCD Panel Technology

Q: What is a Liquid Crystal Display?

A: A Liquid Crystal Display (LCD) is an optical device that is commonly used to display ASCII characters and images on digital items such as watches, calculators, portable game consoles, etc. LCD is the technology used for displays in notebooks and other small computers. Like light-emitting diode and gas-plasma technologies, LCD allows displays to be much thinner than cathode ray tube (CRT) technology. LCD consumes much less power than LED and gas-displays because it works on the principle of blocking light rather than emitting it.

Q: What differentiates passive matrix LCDs from active matrix LCDs?

A: An LCD is made with either a passive matrix or an active matrix display grid. An active matrix has a transistor located at each pixel intersection, requiring less current to control the luminance of a pixel. For this reason, the current in an active matrix display can be switched on and off more frequently, improving the screen refresh time

(your mouse pointer will appear to move more smoothly across the screen, for example). The passive matrix LCD has a grid of conductors with pixels located at each intersection in the grid.

Q: What are the advantages of TFT LCD compared with CRT?

A: In a CRT monitor, a gun shoots electrons and general light by colliding polarized electrons on fluorescent glass. Therefore, CRT monitors basically operate with an analog RGB signal. A TFT LCD monitor is a device that displays an input image by operating a liquid crystal panel. The TFT has a fundamentally different structure than a CRT: Each cell has an active matrix structure and independent active elements. A TFT LCD has two glass panels and the space between them is filled with liquid crystal. When each cell is connected with electrodes and impressed with voltage, the molecular structure of the liquid crystal is altered and controls the amount of inlet lighting to display images. A TFT LCD has several advantages over a CRT, since it can be very thin and no flickering occurs because it does not use the scanning method.

Q: Why is vertical frequency of 60Hz optimal for an LCD monitor?

A: Unlike a CDT monitor, the TFT LCD panel has a fixed resolution. For example, an XGA monitor has 1024x3 (R, G, B) x 768 pixels and a higher resolution may not be available without additional software processing. The panel is designed to optimize the display for a 65MHz dot clock, one of the standards for XGA displays. Since the vertical/horizontal frequency for this dot clock is 60Hz/48kHz, the optimum frequency for this monitor is 60Hz.

Q: What kind of wide-angle technology is available? How does it work?

A: The TFT LCD panel is an element that controls/displays the inlet of a backlight using the dual-refraction of a liquid crystal. Using the property that the projection of inlet light refracts toward the major axis of the liquid element, it controls the direction of inlet light and displays it. Since the refraction ratio of inlet light on liquid crystal varies with the inlet angle of the light, the viewing angle of a TFT is much narrower than that of a CDT. Usually, the viewing angle refers to the point where the contrast ration is 10. Many ways to widen the viewing angle are currently being developed and the most common approach is to use a wide viewing angle film, which widens the viewing angle by varying the refraction ratio. IPS (In Plane Switching) or MVA (Multi Vertical Aligned) is also used to give a wider viewing angle.

Q: Why is there no flicker on an LCD Monitor?

A: Technically speaking, LCDs do flicker, but the cause of the phenomenon is different from that of a CRT monitor -- and it has no impact of the ease of viewing. Flickering in an LCD monitor relates to usually undetectable luminance caused by the difference between positive and negative voltage. On the other hand, CRT flickering that can irritate the human eye occurs when the on/off action of the fluorescent object becomes visible. Since the reaction speed of liquid crystal in an LCD panel is much slower, this troublesome form of flickering is not present in an LCD display.

Q: Why is an LCD monitor virtually low of Electro Magnetic Interference?

A: Unlike a CRT, an LCD monitor does not have key parts that generate Electro Magnetic Interference, especially magnetic fields. Also, since an LCD display utilizes relatively low power, its power supply is extremely quiet.

[RETURN TO TOP OF THE PAGE](#)

Ergonomics, Ecology and Safety Standards

Q: What is the CE mark?

A: The CE (Conformité Européenne) mark is required to be displayed on all regulated products offered for sale on the European market. This 'CE' mark means that a product complies with the relevant European Directive. A European Directive is a European 'Law' that relates to health, safety, environment and consumer protection, much the same as the U.S. National Electrical Code and UL Standards.

Q: Does the LCD monitor conform to general safety standards?

A: Yes. Philips LCD monitors conform to the guidelines of MPR-II and TCO 99/03 standards for the control of radiation, electromagnetic waves, energy reduction, electrical safety in the work environment and recyclability. The specification page provides detailed data on safety standards.

Q: After I change new PC, I found this information on screen, how can I do?

ATTENTION

Theft Mode Enabled

A: Because you activate Theft Deterrence function in SmartControl II. Please contact IT manager or Philips Service Center.

More information is provided in the [Regulatory Information](#) section.

[RETURN TO TOP OF THE PAGE](#)

- Safety and Troubleshooting
- FAQs

•Common Problems

•Imaging Problems



•Regulatory Information

•Other Related Information

Troubleshooting

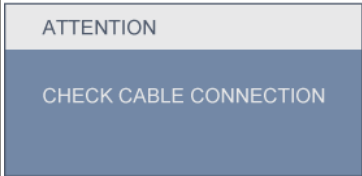
This page deals with problems that can be corrected by a user. If the problem still persists after you have tried these solutions, contact Philips customer service representative.

Common Problems	
Having this problem	Check these items
No Picture (Power LED not lit)	<ul style="list-style-type: none"> ● Make sure the power cord is plugged into the power outlet and into the back of the monitor. ● First, ensure that the power button on the front of the monitor is in the OFF position, then press it to the ON position.
No Picture (Power LED is amber or yellow)	<ul style="list-style-type: none"> ● Make sure the computer is turned on. ● Make sure the signal cable is properly connected to your computer. ● Check to see if the monitor cable has bent pins. ● The Energy Saving feature may be activated
Screen says 	<ul style="list-style-type: none"> ● Make sure the monitor cable is properly connected to your computer. (Also refer to the Quick Set-Up Guide). ● Check to see if the monitor cable has bent pins. ● Make sure the computer is turned on.
AUTO button not working properly	<ul style="list-style-type: none"> ● The Auto Function is designed for use on standard Macintosh or IBM-compatible PCs running Microsoft Windows. ● It may not work properly if using nonstandard PC or video card.
Imaging Problems	

<p>Display position is incorrect</p>	<ul style="list-style-type: none"> ● Press the Auto button. ● Adjust the image position using the Phase/Clock of Setup in OSD Main Controls.
<p>Image vibrates on the screen</p>	<ul style="list-style-type: none"> ● Check that the signal cable is properly connected to the graphics board or PC.
<p>Vertical flicker appears</p> 	<ul style="list-style-type: none"> ● Press the Auto button. ● Eliminate the vertical bars using the Phase/Clock of Setup in OSD Main Controls.
<p>Horizontal flicker appears</p> 	<ul style="list-style-type: none"> ● Press the Auto button. ● Eliminate the vertical bars using the Phase/Clock of Setup in OSD Main Controls.
<p>The screen is too bright or too dark</p>	<ul style="list-style-type: none"> ● Adjust the contrast and brightness on On-Screen Display. (The backlight of the LCD monitor has a fixed life span. When the screen becomes dark or begins to flicker, please contact your sales representative).
<p>An after-image appears</p>	<ul style="list-style-type: none"> ● If an image remains on the screen for an extended period of time, it may be imprinted in the screen and leave an after-image. This usually disappears after a few hours
<p>An after-image remains after the power has been turned off.</p>	<ul style="list-style-type: none"> ● This is characteristic of liquid crystal and is not caused by a malfunction or deterioration of the liquid crystal. The after-image will disappear after a period of time.

Green, red, blue, dark, and white dots remains

- The remaining dots are normal characteristic of the liquid crystal used in today s technology.

Adjust blue "power on" light

- Adjust blue "power on" light using the power LED of Setup in OSD Main Controls.

For further assistance, refer to the [Consumer Information Centers](#) list and contact Philips customer service representative.

[RETURN TO TOP OF THE PAGE](#)

[TCO'06 Information](#)[Recycling Information for Customers](#)[Waste Electrical and Electronic Equipment-WEEE](#)[CE Declaration of Conformity](#)[Energy Star Declaration](#)[Federal Communications Commission \(FCC\) Notice \(U.S. Only\)](#)[FCC Declaration of Conformity](#)[Commission Federale de la Communication \(FCC Declaration\)](#)[EN 55022 Compliance \(Czech Republic Only\)](#)[MIC Notice \(South Korea Only\)](#)[Polish Center for Testing and Certification Notice](#)[North Europe \(Nordic Countries\) Information](#)[BSMI Notice \(Taiwan Only\)](#)[Ergonomie Hinweis \(nur Deutschland\)](#)[Philips End-of-Life Disposal Information for UK only](#)[China RoHS](#)[Safety Information](#)[Troubleshooting](#)[Other Related Information](#)[Frequently Asked Questions \(FAQs\)](#)

Regulatory Information

Model ID: 220CW9

Model No: HWC9220I

TCO'06 Information



Congratulations!

The product you have just purchased carries the TCO'06 Media Displays label. This means that your display is designed and manufactured according to some of the strictest performance and environmental criteria in the world. The manufacturer of this display has selected it to be certified to TCO'06 Media Displays as a sign of usability, high performance and reduced impact on the natural environment.

Products certified to TCO'06 Media Displays are specifically designed for high quality reproduction of moving images. Features such as luminance, color rendition and response time are important when watching TV or working with media, graphics, web design and other applications that demand outstanding moving images. *

Other features of TCO'06 Media Displays:

Ergonomics

- Good visual ergonomics and image quality in order to reduce vision and strain problems. Criteria for luminance, contrast, resolution, reflectance, color rendition and response time.

Energy

- Energy saving mode – beneficial both for the user and the environment
- Electrical safety

Emissions

- Low electromagnetic fields surrounding the display

Ecology

- Product is designed for recycling. Manufacturer must have a certified environmental management system such as EMAS or ISO 14 001
- Restrictions on
 - Chlorinated and brominated flame retardants and polymers.
 - Hazardous heavy metals such as cadmium, mercury, hexavalent chromium and lead.

All TCO labelled products are verified and certified by TCO Development, an independent third party labelling organization. For over 20 years, TCO Development has been at the forefront of moving the design of IT equipment in a more user-friendly direction. Our criteria are developed in collaboration with an international group of researchers, experts, users and manufacturers. Since the program's inception, TCO labelled products have grown in popularity and are now requested by users and IT-manufacturers all over the world.

Full specifications and lists of certified products can be found on our homepage –
www.tcodevelopment.com

* For a display used primarily for conventional work tasks such as word processing, we recommend a display certified to our office display series TCO'03 Displays or later version.

[RETURN TO TOP OF THE PAGE](#)

Recycling Information for Customers

Philips establishes technically and economically viable objectives to optimize the environmental performance of the organization's product, service and activities.

From the planning, design and production stages, Philips emphasizes the important of making products that can easily be recycled. At Philips, end-of-life management primarily entails participation in national take-back initiatives and recycling programs whenever possible, preferably in cooperation with competitors.

There is currently a system of recycling up and running in the European countries, such as The Netherlands, Belgium, Norway, Sweden and Denmark.

In U.S.A., Philips Consumer Electronics North America has contributed funds for the Electronic Industries Alliance (EIA) Electronics Recycling Project and state recycling initiatives for end-of-life electronics products from household sources. In addition, the Northeast Recycling Council (NERC) - a multi-state non-profit organization focused on promoting recycling market development - plans to implement a recycling program.

In Asia Pacific, Taiwan, the products can be taken back by Environment Protection Administration (EPA) to follow the IT product recycling management process, detail can be found in web site www.epa.gov.tw

The monitor contains parts that could cause damage to the nature environment. Therefore, it is vital that the monitor is recycled at the end of its life cycle.

For help and service, please contact [Consumers Information Center](#) or [F1rst Choice Contact Information Center](#) in each country or the following team of Environmental specialist can help.

Mrs. Argent Chan, Environment Manager
Philips Consumer Lifestyle
E-mail: argent.chan@philips.com
Tel: +886 (0) 3 222 6795

Mr. Maarten ten Houten - Senior Environmental Consultant
Philips Consumer Electronics
E-mail: marten.ten.houten@philips.com
Tel: +31 (0) 40 27 33402

Mr. Delmer F. Teglas
Philips Consumer Electronics North America
E-mail: butch.teglas@philips.com
Tel: +1 865 521 4322

[RETURN TO TOP OF THE PAGE](#)

Waste Electrical and Electronic Equipment-WEEE

Attention users in European Union private households



This marking on the product or on its packaging illustrates that, under European Directive 2002/96/EG governing used electrical and electronic appliances, this product may not be disposed of with normal household waste. You are responsible for disposal of this equipment through a designated waste electrical and electronic equipment collection. To determine the locations for dropping off such waste electrical and electronic, contact your local government office, the waste disposal organization that serves your household or the store at which you purchased the product.

Attention users in United States:

Like all LCD products, this set contains a lamp with Mercury. Please dispose of according to all Local, State and Federal laws. For the disposal or recycling information, contact www.mygreenelectronics.com or www.eiae.org.

[RETURN TO TOP OF THE PAGE](#)

CE Declaration of Conformity

Philips Consumer Electronics declare under our responsibility that the product is in conformity with the following standards

- EN60950-1:2001 (Safety requirement of Information Technology Equipment)
- EN55022:1998 (Radio Disturbance requirement of Information Technology Equipment)
- EN55024:1998 (Immunity requirement of Information Technology Equipment)
- EN61000-3-2:2000 (Limits for Harmonic Current Emission)
- EN61000-3-3:1995 (Limitation of Voltage Fluctuation and Flicker)

following provisions of directives applicable

- 73/23/EEC (Low Voltage Directive)
 - 89/336/EEC (EMC Directive)
 - 93/68/EEC (Amendment of EMC and Low Voltage Directive)
- and is produced by a manufacturing organization on ISO9000 level.

The product also comply with the following standards

- ISO9241-3, ISO9241-7, ISO9241-8 (Ergonomic requirement for CRT Monitor)
- ISO13406-2 (Ergonomic requirement for Flat Panel Display)
- GS EK1-2000 (GS specification)
- prEN50279:1998 (Low Frequency Electric and Magnetic fields for Visual Display)
- MPR-II (MPR:1990:8/1990:10 Low Frequency Electric and Magnetic fields)
- TCO'99, TCO'03 (Requirement for Environment Labelling of Ergonomics, Energy, Ecology and Emission, TCO: Swedish Confederation of Professional Employees) for TCO versions

[RETURN TO TOP OF THE PAGE](#)

Energy Star Declaration

This monitor is equipped with a function for saving energy which supports the VESA Display Power Management Signaling (DPMS) standard. This means that the monitor must be connected to a computer which supports VESA DPMS. Time settings are adjusted from the system unit by software.

	VESA State	LED Indicator	Power Consumption
Normal operation	ON (Active)	Blue	< 45W (typ.)
Power Saving Alternative 2 One step	Sleep	Blue Blinking	< 1 W
	Switch Off	Off	< 0.8 W



As an ENERGY STAR® Partner, PHILIPS has determined that this product meets the ENERGY STAR® guidelines for energy efficiency.



We recommend you switch off the monitor when it is not in use for a long time.

[RETURN TO TOP OF THE PAGE](#)

Federal Communications Commission (FCC) Notice (U.S. Only)



This equipment has been tested and found to comply with the limits for a Class B digital device, pursuant to Part 15 of the FCC Rules. These limits are designed to provide reasonable protection against harmful interference in a residential installation. This equipment generates, uses and can radiate radio frequency energy and, if not installed and used in accordance with the instructions, may cause harmful interference to radio communications. However, there is no guarantee that interference will not occur in a particular installation. If this equipment does cause harmful interference to radio or television reception, which can be determined by turning the equipment off and on, the user is encouraged to try to correct the interference by one or more of the following measures:

- Reorient or relocate the receiving antenna.
- Increase the separation between the equipment and receiver.
- Connect the equipment into an outlet on a circuit different from that to which the receiver is connected.
- Consult the dealer or an experienced radio/TV technician for help.



Changes or modifications not expressly approved by the party responsible for compliance could void the user's authority to operate the equipment.

Use only RF shielded cable that was supplied with the monitor when connecting this monitor to a computer device.

To prevent damage which may result in fire or shock hazard, do not expose this appliance to rain or excessive moisture.

THIS CLASS B DIGITAL APPARATUS MEETS ALL REQUIREMENTS OF THE CANADIAN INTERFERENCE-CAUSING EQUIPMENT REGULATIONS.

[RETURN TO TOP OF THE PAGE](#)

FCC Declaration of Conformity

Trade Name: Philips
Philips Consumer Electronics North America
P.O. Box 671539
Responsible Party: Marietta, GA 30006-0026
1-888-PHILIPS (744-5477)

Declaration of Conformity for Products Marked with FCC Logo,
United States Only

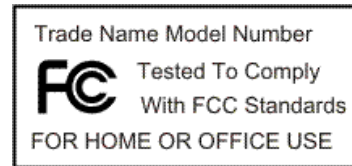

This device complies with Part 15 of the FCC Rules. Operation is subject to the following two conditions: (1) this device may not cause harmful interference, and (2) this device must accept any interference received, including interference that may cause undesired operation.

[RETURN TO TOP OF THE PAGE](#)

Commission Federale de la Communication (FCC Declaration)



Cet équipement a été testé et déclaré conforme aux limites des appareils numériques de class B, aux termes de l'article 15 Des règles de la FCC. Ces limites sont conçues de façon à fournir une protection raisonnable contre les interférences nuisibles dans le cadre d'une installation résidentielle. CET appareil produit, utilise et peut émettre des hyperfréquences qui, si l'appareil n'est pas installé et utilisé selon les consignes données, peuvent causer des interférences nuisibles aux communications radio. Cependant, rien ne peut garantir l'absence d'interférences dans le cadre d'une installation particulière. Si cet appareil est la cause d'interférences nuisibles pour la réception des signaux de radio ou de télévision, ce qui peut être décelé en fermant l'équipement, puis en le remettant en fonction, l'utilisateur pourrait essayer de corriger la situation en prenant les mesures suivantes:

- Réorienter ou déplacer l'antenne de réception.
- Augmenter la distance entre l'équipement et le récepteur.
- Brancher l'équipement sur un autre circuit que celui utilisé par le récepteur.
- Demander l'aide du marchand ou d'un technicien chevronné en radio/télévision.



Toutes modifications n'ayant pas reçu l'approbation des services compétents en matière de conformité est susceptible d'interdire à l'utilisateur l'usage du présent équipement.

N'utiliser que des câbles RF armés pour les connections avec des ordinateurs ou périphériques.

CET APPAREIL NUMERIQUE DE LA CLASSE B RESPECTE TOUTES LES EXIGENCES DU REGLEMENT SUR LE MATERIEL BROUILLEUR DU CANADA.

[RETURN TO TOP OF THE PAGE](#)

EN 55022 Compliance (Czech Republic Only)

This device belongs to category B devices as described in EN 55022, unless it is specifically stated that it is a Class A device on the specification label. The following applies to devices in Class A of EN 55022 (radius of protection up to 30 meters). The user of the device is obliged to take all steps necessary to remove sources of interference to telecommunication or other devices.

Pokud není na typovém štítku počítače uvedeno, že spadá do třídy A podle EN 55022, spadá automaticky do třídy B podle EN 55022. Pro zařízení zařazená do třídy A (chranné pásmo 30m) podle EN 55022 platí následující. Dojde-li k rušení telekomunikačních nebo jiných zařízení je uživatel povinen provést taková opatření, aby rušení odstranil.

[RETURN TO TOP OF THE PAGE](#)

MIC Notice (South Korea Only)

Class B Device

장치 종류	사용자 안내문
B급 기기	이 장치는 가정용으로 전자파 적합등록을 한 장치로서 주거지역에서는 물론 모든 지역에서 사용할 수 있습니다.



Please note that this device has been approved for non-business purposes and may be used in any environment, including residential areas.

[RETURN TO TOP OF THE PAGE](#)

Polish Center for Testing and Certification Notice

The equipment should draw power from a socket with an attached protection circuit (a three-prong socket). All equipment that works together (computer, monitor, printer, and so on) should have the same power supply source.

The phasing conductor of the room's electrical installation should have a reserve short-circuit protection device in the form of a fuse with a nominal value no larger than 16 amperes (A).

To completely switch off the equipment, the power supply cable must be removed from the power supply socket, which should be located near the equipment and easily accessible.

A protection mark "B" confirms that the equipment is in compliance with the protection usage requirements of standards PN-93/T-42107 and PN-89/E-06251.

Wymagania Polskiego Centrum Badań i Certyfikacji

Urządzenie powinno być zasilane z gniazda z przyłączonym obwodem ochronnym (gniazdo z kółkiem). Współpracujące ze sobą urządzenia (komputer, monitor, drukarka) powinny być zasilane z tego samego źródła.

Instalacja elektryczna pomieszczenia powinna zawierać w przewodzie fazowym rezerwową ochronę przed zwarciami, w postaci bezpiecznika o wartości znamionowej nie większej niż 16A (amperów).

W celu całkowitego wyłączenia urządzenia z sieci zasilania, należy wyjąć wtyczkę kabla zasilającego z gniazda, które powinno znajdować się w pobliżu urządzenia i być łatwo dostępne.

Znak bezpieczeństwa "B" potwierdza zgodność urządzenia z wymaganiami bezpieczeństwa użytkownika zawartymi w PN-93/T-42107 i PN-89/E-06251.

Pozostałe instrukcje bezpieczeństwa

- Nie należy używać wtyczek adapterowych lub usuwać kołka obwodu ochronnego z wtyczki. Jeżeli konieczne jest użycie przedłużacza to należy użyć przedłużacza 3-żyłowego z prawidłowo połączonym przewodem ochronnym.
- System komputerowy należy zabezpieczyć przed nagłymi, chwilowymi wzrostami lub spadkami napięcia, używając eliminatora przepięć, urządzenia dopasowującego lub bezzakłócenowego źródła zasilania.
- Należy upewnić się, aby nic nie leżało na kablach systemu komputerowego, oraz aby kable nie były umieszczone w miejscu, gdzie można byłoby na nie nadeptywać lub potykać się o nie.
- Nie należy rozlewać napojów ani innych płynów na system komputerowy.
- Nie należy wpychać żadnych przedmiotów do otworów systemu komputerowego, gdyż może to spowodować pożar lub porażenie prądem, poprzez zwarcie elementów wewnętrznych.
- System komputerowy powinien znajdować się z dala od grzejników i źródeł ciepła. Ponadto, nie należy blokować otworów wentylacyjnych. Należy unikać kładzenia luznych papierów pod komputer oraz umieszczania komputera w ciasnym miejscu bez możliwości cyrkulacji powietrza wokół niego.

[RETURN TO TOP OF THE PAGE](#)

North Europe (Nordic Countries) Information

Placering/Ventilation

WARNING:

FÖRSÄKRA DIG OM ATT HUVUDBRYTARE OCH UTTAG ÄR LÄTÅTKOMLIGA, NÄR DU STÄLLER DIN UTRUSTNING PÅPLATS.

Placering/Ventilation

ADVARSEL:

SØRG VED PLACERINGSFOR, AT NETLEDNINGENS STIK OG STIKKONTAKT ER NEMT TILGÆNGELIGE.

Paikka/Ilmankierto

VAROITUS:

SIJOITA LAITE SITEN, ETTÄ VERKKOJOHTO VOIDAAN TARVITTAESSA HELPOSTI IRROTTAA PISTORASIASTA.

Plassering/Ventilasjon

ADVARSEL:

NÅR DETTE UTSTYRET PLASSERES, MÅ DU PASSE PÅ AT KONTAKTENE FOR STØMTILFØRSEL ER LETTE Å NÅ.

[RETURN TO TOP OF THE PAGE](#)

BSMI Notice (Taiwan Only)

符合乙類資訊產品之標準

[RETURN TO TOP OF THE PAGE](#)

Ergonomie Hinweis (nur Deutschland)

Der von uns gelieferte Farbmonitor entspricht den in der "Verordnung über den Schutz vor Schäden durch Röntgenstrahlen" festgelegten Vorschriften.

Auf der Rückwand des Gerätes befindet sich ein Aufkleber, der auf die Unbedenklichkeit der Inbetriebnahme hinweist, da die Vorschriften über die Bauart von Störstrahlern nach Anlage III \square 5 Abs. 4 der Röntgenverordnung erfüllt sind.

Damit Ihr Monitor immer den in der Zulassung geforderten Werten entspricht, ist darauf zu achten, daß

1. Reparaturen nur durch Fachpersonal durchgeführt werden.
2. nur original-Ersatzteile verwendet werden.
3. bei Ersatz der Bildröhre nur eine bauartgleiche eingebaut wird.

Aus ergonomischen Gründen wird empfohlen, die Grundfarben Blau und Rot nicht auf dunklem Untergrund zu verwenden (schlechte Lesbarkeit und erhöhte Augenbelastung bei zu geringem Zeichenkontrast wären die Folge).

Der arbeitsplatzbezogene Schalldruckpegel nach DIN 45 635 beträgt 70dB (A) oder weniger.



ACHTUNG: BEIM AUFSTELLEN DIESES GERÄTES DARAUFG ACHTEN, DAß NETZSTECKER UND NETZKABELANSCHLUß LEICHT ZUGÄNGLICH SIND.

[RETURN TO TOP OF THE PAGE](#)

End-of-Life Disposal

Your new monitor contains materials that can be recycled and reused. Specialized companies can recycle your product to increase the amount of reusable materials and to minimize the amount to be disposed of.

Please find out about the local regulations on how to dispose of your old monitor from your local Philips dealer.

(For customers in Canada and U.S.A.)

This product may contain lead and/or mercury. Dispose of in accordance to local-state and federal regulations. For additional information on recycling contact www.eia.org (Consumer Education Initiative)

[RETURN TO TOP OF THE PAGE](#)

Information for UK only

WARNING - THIS APPLIANCE MUST BE GROUNDING.

Important:

This apparatus is supplied with an approved moulded 13A plug. To change a fuse in this type of plug proceed as follows:

1. Remove fuse cover and fuse.
2. Fit new fuse which should be a BS 1362 5A, A.S.T.A. or BSI approved type.
3. Refit the fuse cover.

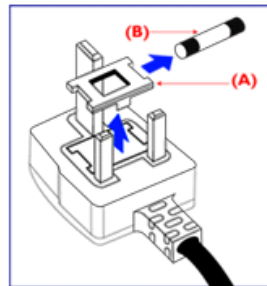

If the fitted plug is not suitable for your socket outlets, it should be cut off and an appropriate 3-pin plug fitted in its place.

If the mains plug contains a fuse, this should have a value of 5A. If a plug without a fuse is used, the fuse at the distribution board should not be greater than 5A.

Note: The severed plug must be destroyed to avoid a possible shock hazard should it be inserted into a 13A socket elsewhere.

How to connect a plug

The wires in the mains lead are coloured in accordance with the following code:

BLUE - "NEUTRAL" ("N")

BROWN - "LIVE" ("L")

GREEN & YELLOW - "GROUND" ("G")

1. The GREEN AND YELLOW wire must be connected to the terminal in the plug which is marked with the letter "G" or by the Ground symbol  or coloured GREEN or GREEN AND YELLOW.

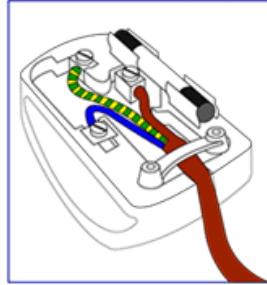

2. The BLUE wire must be connected to the terminal which is marked with the letter "N" or coloured BLACK.

3. The BROWN wire must be connected to the terminal which marked with the letter "L" or coloured RED.

Before replacing the plug cover, make certain that the cord grip is clamped over the sheath of the lead - not simply over the three wires.

[RETURN TO TOP OF THE PAGE](#)

China RoHS

The People's Republic of China released a regulation called "Management Methods for Controlling Pollution by Electronic Information Products" or commonly referred to as China RoHS. All products including CRT and LCD monitor which are produced and sold for China market have to meet China RoHS request.

中国大陆RoHS

根据中国大陆《电子信息产品污染控制管理办法》（也称为中国大陆RoHS），以下部分列出了本产品中可能包含的有毒有害物质或元素的名称和含量

本表适用之产品

显示器（液晶及CRT）

有毒有害物质或元素

部件名称	有毒有害物质或元素					
	铅 (Pb)	汞 (Hg)	镉 (Cd)	六价铬 (Cr6+)	多溴联苯 (PBB)	多溴二苯醚 (PBDE)
外壳	○	○	○	○	○	○
CRT显示屏	×	○	○	○	○	○
液晶显示屏/灯管	×	×	○	○	○	○
电路板组件*	×	○	○	○	○	○
电源适配器	×	○	○	○	○	○
电源线/连接线	×	○	○	○	○	○

*：电路板组件包括印刷电路板及其构成的零部件，如电阻、电容、集成电路、连接器等
○：表示该有毒有害物质在该部件所有均质材料中的含量均在《电子信息产品中有毒有害物质的限量要求标准》规定的限量要求以下
×：表示该有毒有害物质至少在该部件的某一均质材料中的含量超出《电子信息产品中有毒有害物质的限量要求标准》规定的限量要求；但是上表中打“×”的部件，符合欧盟RoHS法规要求（属于豁免的部分）

[RETURN TO TOP OF THE PAGE](#)

Safety Information: Electric, Magnetic and Electromagnetic Fields ("EMF")

1. Philips Royal Electronics manufactures and sells many products targeted at consumers, which, like any electronic apparatus, in general have the ability to emit and receive electro magnetic signals.
2. One of Philips' leading Business Principles is to take all necessary health and safety measures for our products, to comply with all applicable legal requirements and to stay well within the EMF standards applicable at the time of producing the products.
3. Philips is committed to develop, produce and market products that cause no adverse health effects.
4. Philips confirms that if its products are handled properly for their intended use, they are safe to use according to scientific evidence available today.
5. Philips plays an active role in the development of international EMF and safety standards, enabling Philips to anticipate further developments in standardization for early integration in its products.

[RETURN TO TOP OF THE PAGE](#)

[Safety and Troubleshooting](#)

[FAQs](#)

[Troubleshooting](#)

[Regulatory Information](#)

[Information](#)

[for Users in the U.S](#)

[Information](#)

[for Users Outside the U.S](#)

Other Related Information

Information for Users in the U. S.

For units set at 115 V :

Use a UL Listed Cord Set consisting of a minimum 18 AWG, Type SVT or SJT three conductor cord a maximum of 15-feet long and a parallel blade, grounding type attachment plug rated 15 A, 125 V.

For units set at 230 V:

Use a UL Listed Cord Set consisting of a minimum 18 AWG, Type SVT or SJT three conductor cord a maximum of 15-feet long and a tandem blade, grounding type attachment plug rated 15 A, 250 V.

Information for Users outside the U.S.

For units set at 230 V:

Use a Cord Set consisting of a minimum 18 AWG cord and grounding type attachment plug rated 15 A, 250 V. The Cord Set should have the appropriate safety approvals for the country in which the equipment will be installed and / or be marked HAR.

[RETURN TO TOP OF THE PAGE](#)

[About This Guide](#)

[Notational Descriptions](#)

About This Manual

About This Guide

This electronic user's guide is intended for anyone who uses the Philips LCD Monitor. It describes the LCD monitor's features, setup, operation and other important information. Its contents are identical to the information in our printed version.

It includes the following sections:

- [Safety and Troubleshooting Information](#) provides tips and solutions for common problems as well as other related information you may need.
- About This Electronic User's Manual gives an overview of information included, along with notation icon descriptions and other documentation for your reference.
- [Product Information](#) gives an overview of the monitor's features as well as the technical specifications for this monitor.
- [Installing Your Monitor](#) describes the initial setup process and gives an overview of how to use the monitor.
- [On-Screen Display](#) provides information on adjusting the settings on your monitor.
- [Customer Care and Warranty](#) contains a list of worldwide Philips Consumer Information Centers along with help desk phone numbers and information on the warranty applicable to your product.
- [Glossary](#) defines technical terms.
- [Download and Print Option](#) transfers this entire manual to your hard drive for easy reference.

[RETURN TO TOP OF THE PAGE](#)

Notational Descriptions

The following subsections describe notational conventions used in this document.

Notes, Cautions and Warnings

Throughout this guide, blocks of text may be accompanied by an icon and printed in bold or italic type. These blocks contain notes, cautions or warnings. They are used as follows:



NOTE: This icon indicates important information and tips that help you make better use of your computer system.



CAUTION: This icon indicates information that tells you how to avoid either potential damage to hardware or loss of data.



WARNING: This icon indicates the potential for bodily harm and tells you how to avoid the problem.

Some warnings may appear in alternate formats and may not be accompanied by an icon. In such cases, the specific presentation of the warning is mandated by the relevant regulatory authority.

[RETURN TO TOP OF THE PAGE](#)

©2008 Koninklijke Philips Electronics NV

All rights reserved. Reproduction, copying, use, modification, hiring, renting, public performance, transmission and/or broadcasting in whole or in part is prohibited without written consent of Philips Electronics NV

Your LCD Monitor
SmartImage
SmartContrast

SmartSaturate
SmartSharpness
Lead-free Product
Technical Specifications
Resolution & Preset Modes
Philips Pixel Defect Policy
Automatic Power Saving
Physical Specification
Pin Assignment
Product Views
Physical Function
SmartManage & SmartControl
II

Product Information

Your LCD monitor

Congratulations on your purchase and welcome to Philips. To fully benefit from the support that Philips offers, register your product at. www.philips.com/welcome

[RETURN TO TOP OF THE PAGE](#)

SmartImage

What is it?

SmartImage provides presets that optimize display for different types of content, dynamically adjusting brightness, contrast, color and sharpness in real time. Whether you're working with text applications, displaying images or watching a video, Philips SmartImage delivers great optimized LCD display performance.

Why do I need it?



You want a LCD display that delivers optimized display all your favorite types of content, SmartImage software dynamically adjust brightness, contrast, color and sharpness in real time to enhance your LCD viewing experience.

How does it work?

SmartImage - software based on Philips award-winning LightFrame™ technology - analyzes the content displayed on your screen. Based on a scenario you select, SmartImage dynamically enhances the contrast, color saturation and sharpness of images and video for ultimate display performance - all in real time with the press on a single button.

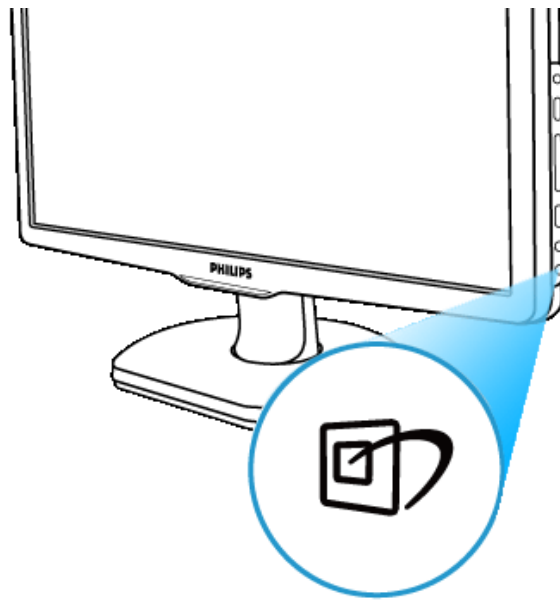
How to enable SmartImage?



1. Press  to launch the SmartImage on screen display;
2. Keep press  to toggle between Office Work, Image Viewing, Entertainment, Economy, and Off;
3. The SmartImage on screen display will remain on screen for 5 seconds or you can also press "OK" to make confirmation.
4. When SmartImage is enabled, the sRGB scheme is disabled automatically. To use sRGB you need to disable SmartImage with the  button at the front bezel of your monitor.

Except using  key to scroll down, you can also press ▼ ▲ buttons to choose and press "OK" to confirm selection and close the SmartImage OSD. There are five modes to be selected: Office Work, Image Viewing, Entertainment, Economy, and Off.

There are five modes to be selected: Office Work, Image Viewing, Entertainment, Economy, and Off.

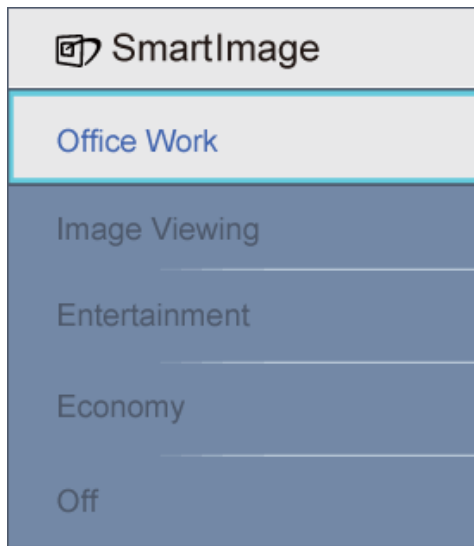

1. **Office Work:** Enhances text and dampens brightness to increase readability and reduce eye strain. This mode significantly enhances readability and productivity when you're working with spreadsheets, PDF files, scanned articles or other general office applications.
2. **Image Viewing:** This profile combines color saturation, dynamic contrast and sharpness enhancement to display photos and other images with outstanding clarity in vibrant colors - all without artifacts and faded colors.
3. **Entertainment:** Ramped up luminance, deepened color saturation, dynamic contrast and razor sharpness displays every details in darker areas of your videos without color washout in brighter areas maintaining a dynamic natural values for the ultimate video display.
4. **Economy:** Under this profile, brightness, contrast are adjusted and backlighting fine-tuned for just right display of everyday office applications and lower power consumption.
5. **Off:** No optimization by SmartImage.

[RETURN TO TOP OF THE PAGE](#)

SmartContrast

What is it?

Unique technology that dynamically analyzes displayed content and automatically optimizes a LCD monitor's contrast ratio for maximum visual clarity and viewing enjoyment, stepping up backlighting for clearer, crisper and brighter images or dimming backlighting for clear display of images on dark backgrounds.

Why do I need it?

You want the very best visual clarity and viewing comfort for every type of content. SmartContrast dynamically controls contrast and adjusts backlighting for clear, crisp, bright gaming and video images or displays clear, readable text for office work. By reducing your monitor's power consumption, you save on energy costs and extend the lifetime of your monitor.

How does it work?

When you active SmartContrast which will analysis the content you are displaying in real time to adjust colors and control backlight intensity. This function can obviously enhance contrast in dynamic for more entertainment fun when viewing videos or playing games.

[RETURN TO TOP OF THE PAGE](#)

SmartSaturate

What is it?

Smart technology that controls color saturation - the degree to which one on screen color is diluted by neighboring colors - to deliver rich and vibrant images for more entertainment fun when you are viewing videos.

Why do I need it?

You want rich, vibrant images for more entertainment fun when viewing photos or videos.

How does it work?

SmartSaturate dynamically controls color saturation - the degree to which on-screen color is diluted by neighboring colors - to deliver rich, vibrant display for more entertainment fun when you are viewing images or videos in your display's Entertainment mode and is turned off for top quality display of office application and in the Economy mode to reduce power consumption.

[RETURN TO TOP OF THE PAGE](#)

SmartSharpness

What is it?

Smart technology that enhances sharpness when you need it for ultimate display performance and more entertainment fun when you are viewing videos or photos.

Why do I need it?

You want the ultimate in sharpness for more entertainment fun when viewing photos or videos.

How does it work?

Smart technology enhances sharpness when you need it for ultimate display performance and more entertainment fun when you are viewing videos or photos in the Entertainment mode and is turned off for top quality display of office applications and in the Economy mode to reduce power consumptions.

[RETURN TO TOP OF THE PAGE](#)

Lead-free Product



Philips eliminated toxic substances like lead from its displays. Lead-free display helps protect your health and promotes environmentally sound recovery and disposal of waste from electrical and electronic equipment. Philips complies with the European Community stringent RoHS Directive mandating restrictions on hazardous substances in electrical and electronic equipment. With Philips, you can be confident that your display device does not harm the environment.

[RETURN TO TOP OF THE PAGE](#)

Technical Specifications*

LCD PANEL	
Type	TFT LCD
Screen size	22" visual
Pixel Pitch	0.282 x 0.282 mm
LCD Panel type	1680 x 1050 pixels R.G.B. vertical stripe Anti-glare polarizer, hard coated
Effective viewing area	473.76 x 296.1 mm
SCANNING	
Vertical refresh rate	56 Hz-76 Hz
Horizontal Frequency	30 kHz - 83 kHz
VIDEO	
Video dot rate	165 MHz
Input impedance	

- Video	75 ohm
- Sync	2.2K ohm
Input signal levels	0.7 Vpp
Sync input signal	Separate sync Composite sync Sync on green
Sync polarities	Positive and negative

** This data is subject to change without notice.*

[RETURN TO TOP OF THE PAGE](#)

Resolution & Preset Modes

A. Maximum Resolution

- For 220CW9
 - 1680 x 1050 at 75 Hz (analog input)
 - 1680 x 1050 at 60 Hz (digital input)

B. Recommended Resolution

- For 220CW9
 - 1680 x 1050 at 60 Hz (digital input)

18 factory preset modes:

H. freq (kHz)	Resolution	V. freq (Hz)
31.469	640*350	70.086
31.469	720*400	70.087
31.469	640*480	59.940
35.000	640*480	67.000
37.500	640*480	75.000
35.156	800*600	56.250
37.879	800*600	60.317
46.875	800*600	75.000
48.363	1024*768	60.004
60.023	1024*768	75.029
63.981	1280*1024	60.020
79.976	1280*1024	75.025
55.469	1440*900	59.901
55.935	1440*900	59.887
70.635	1440*900	74.984
65.290	1680*1050	60.000
64.674	1680*1050	60.000
66.587	1920*1080	60.000

[RETURN TO TOP OF THE PAGE](#)

Automatic Power Saving

If you have VESA DPMS compliance display card or software installed in your PC, the monitor can automatically reduce its power consumption when not in use. If an input from a keyboard, mouse or other input device is detected, the monitor will 'wake up' automatically. The following table shows the power consumption and signaling of this automatic power saving feature:

Power Management Definition					
VESA Mode	Video	H-sync	V-sync	Power Used	LED color
Active	ON	Yes	Yes	< 45W (typ.)	Blue
Sleep	OFF	No	No	< 1 W	Blue Blinking

Switch Off	OFF	-	-	< 0.8 W	Off
------------	-----	---	---	---------	-----

This monitor is ENERGY STAR® compliant. As an ENERGY STAR® Partner, PHILIPS has determined that this product meets the ENERGY STAR® guidelines for energy efficiency.

[RETURN TO TOP OF THE PAGE](#)

Physical Specifications

Tilt	-5°+2/-0 ~+ 20°+3/-0
Power supply	100 ~ 240 VAC, 50/60 Hz
Power consumption	45W* (typ.)
Temperature	0° C to 40 ° C (operating) -20° C to 60° C (storage)
Relative humidity	20% to 80%
System MTBF	50K hours (CCFL 50K hours)

* This data is subject to change without notice.

The native resolution of the monitor is 1680 x 1050. By default, your monitor has 100% brightness (max.), 50% contrast, and 6500K color temperature, with a full white pattern.

[RETURN TO TOP OF THE PAGE](#)

Pin Assignment

1. The digital only connector contains 24 signal contacts organized in three rows of eight contacts. Signal pin assignments are listed in the following table:

Pin No.	Signal Assignment	Pin No.	Signal Assignment	Pin No.	Signal Assignment
1	T.M.D.S. Data2-	9	T.M.D.S. Data1-	17	T.M.D.S. Data0-
2	T.M.D.S. Data2+	10	T.M.D.S. Data1+	18	T.M.D.S. Data0+
3	T.M.D.S. Data2/4 Shield	11	T.M.D.S. Data1/3 Shield	19	T.M.D.S. Data0/5 Shield
4	No connect	12	No connect	20	No connect

5	No connect	13	No connect	21	No connect
6	DDC Clock	14	+5V Power	22	T.M.D.S. Clock Shield
7	DDC Data	15	Ground (for +5V)	23	T.M.D.S. Clock+
8	No connect	16	Hot Plug Detect	24	T.M.D.S. Clock-

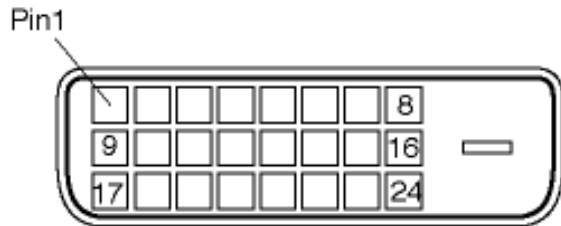

2.The 15-pin D-sub connector (male) of the signal cable:

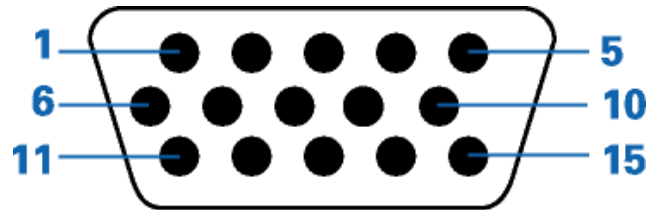

Pin No.	Assignment	Pin No.	Assignment
1	Red video input	9	DDC + 5 V
2	Green video input/SOG	10	Logic ground
3	Blue video input	11	Ground
4	Sense (GND)	12	Serial data line (SDA)
5	Cable detect (GND)	13	H. Sync / H+V. Sync
6	Red video ground	14	V. Sync
7	Green video ground	15	Data clock line (SCL)
8	Blue video ground		

[RETURN TO TOP OF THE PAGE](#)

Product Views

Follow the links to see various views of the monitor and its components.

[Front View Product Description](#)

[RETURN TO TOP OF THE PAGE](#)

Physical Function

Tilt

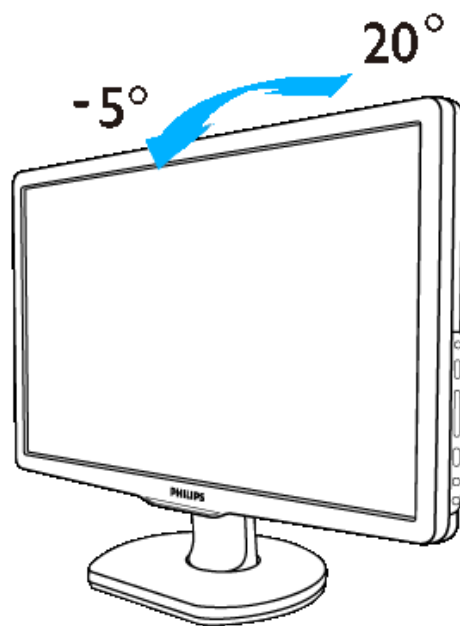

[RETURN TO TOP OF THE PAGE](#)

[Product Features](#)[Technical Specifications](#)[Resolution & Preset Modes](#)[Automatic Power Saving](#)[Physical Specification](#)[Pin Assignment](#)[Product Views](#)

Philips Pixel Defect Policy

Philips' Flat Panel Monitors Pixel Defect Policy

Philips strives to deliver the highest quality products. We use some of the industry's most advanced manufacturing processes and practice stringent quality control. However, pixel or sub pixel defects on the TFT LCD panels used in flat panel monitors are sometimes unavoidable. No manufacturer can guarantee that all panels will be free from pixel defects, but Philips guarantees that any monitor with an unacceptable number of defects will be repaired or replaced under warranty. This notice explains the different types of pixel defects and defines acceptable defect levels for each type. In order to qualify for repair or replacement under warranty, the number of pixel defects on a TFT LCD panel must exceed these acceptable levels. For example, no more than 0.0004% of the sub pixels on a 19" XGA monitor may be defective. Furthermore, Philips sets even higher quality standards for certain types or combinations of pixel defects that are more noticeable than others. This policy is valid worldwide.

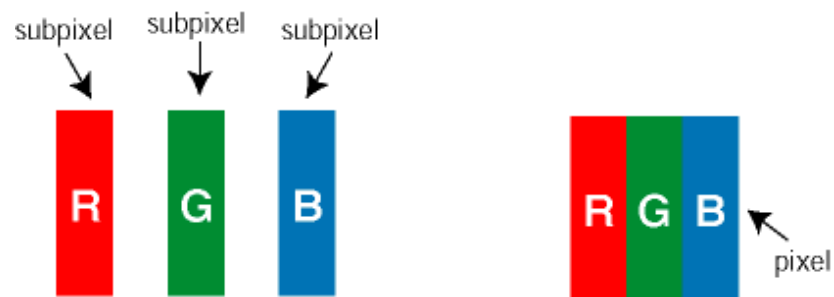

Pixels and Sub pixels

A pixel, or picture element, is composed of three sub pixels in the primary colors of red, green and blue. Many pixels together form an image. When all sub pixels of a pixel are lit, the three colored sub pixels together appear as a single white pixel. When all are dark, the three colored sub pixels together appear as a single black pixel. Other combinations of lit and dark sub pixels appear as single pixels of other colors.

Types of Pixel Defects

Pixel and sub pixel defects appear on the screen in different ways. There are two categories of pixel

defects and several types of sub pixel defects within each category.

Bright Dot Defects Bright dot defects appear as pixels or sub pixels that are always lit or 'on'. That is, a *bright dot* is a sub-pixel that stands out on the screen when the monitor displays a dark pattern. There are the types of bright dot defects:

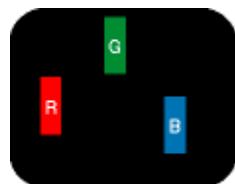

One lit red, green or blue sub pixel

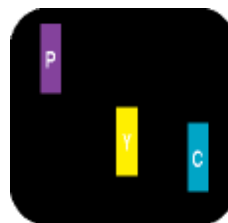

Two adjacent lit sub pixels:

- Red + Blue = Purple
- Red + Green = Yellow
- Green + Blue = Cyan (Light Blue)



Three adjacent lit sub pixels (one white pixel)



A red or blue *bright dot* must be more than 50 percent brighter than neighboring dots while a green *bright dot* is 30 percent brighter than neighboring dots.

Black Dot Defects Black dot defects appear as pixels or sub pixels that are always dark or 'off'. That is, a *dark dot* is a sub-pixel that stands out on the screen when the monitor displays a light pattern. These are the types of black dot defects:

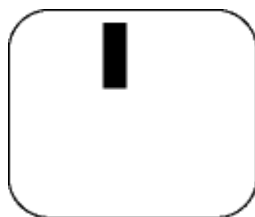

One dark sub pixel

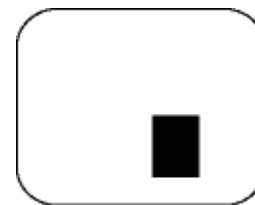

Two or three adjacent dark sub pixels

Proximity of Pixel Defects

Because pixel and sub pixels defects of the same type that are near to one another may be more noticeable, Philips also specifies tolerances for the proximity of pixel defects.

Pixel Defect Tolerances

In order to qualify for repair or replacement due to pixel defects during the warranty period, a TFT LCD panel in a Philips flat panel monitor must have pixel or sub pixel defects exceeding the tolerances listed in the following tables.

BRIGHT DOT DEFECTS	ACCEPTABLE LEVEL
<i>MODEL</i>	220CW9
1 lit subpixel	3
2 adjacent lit subpixels	1
3 adjacent lit subpixels (one white pixel)	0
Distance between two bright dot defects*	>15mm
Total bright dot defects of all types	3

BLACK DOT DEFECTS	ACCEPTABLE LEVEL
<i>MODEL</i>	220CW9
1 dark subpixel	5
2 adjacent dark subpixels	2
3 adjacent dark subpixels	0
Distance between two black dot defects*	>15mm
Total black dot defects of all types	5

TOTAL DOT DEFECTS	ACCEPTABLE LEVEL
<i>MODEL</i>	220CW9
Total bright or black dot defects of all types	5

Note:

** 1 or 2 adjacent sub pixel defects = 1 dot defect*

[RETURN TO TOP OF THE PAGE](#)

[Product Information](#)[Philips Pixel Defect Policy](#)[SmartManage Features and Benefits](#)[Philips SmartControl II](#)[System support and requirement](#)[Installation](#)[Start to use](#)[Q&A](#)

SmartManage & SmartControl II (Selective Models)



Introduction

Philips SmartManage is an advanced solution for users, corporate/institution IT administrator in particular, to manage their Philips monitors as part of the asset management environment. The solution includes three essential components, Philips SmartManage Administrator, and Philips SmartControl and Agent.

If you are a small to middle business company, you may not need such professional software to do the asset management. Thus, Philips provide you a compact version of SmartManage, SmartManage Lite. You can use SmartManage Lite to manage your Philips Monitors via LAN. Please refer to below comparison chart and determine if which one suit for your environment best.

Functions & Features Manage	SmartManage PC & Monitor	SmartManage Lite Monitor
Five key features of SmartManage		
Security Management	● SmartManage will indicate if display are moved from their assigned location by providing a warning message to a designated manager or e-mail account. Also the monitor moved out from Network will havewarning message on the screen and power off after 10 min.	●(Lite version) IT Manager can tell the asset list to find out if there is display missing. Suit for small to mid-range company. Also optional feature of self deference which cannot display correctly without correct PIN number.
Power Saving Management	● Remote switch unattended Display	● Remote switch unattended Display
Remote Operation Management - Performance and setting	● Remote adjust or reset Display seeting	● Remote adjust or reset Display seeting
Asset tracking Management	● Full sortable and report of data for IT manager to manage such as S/N, Resolution, Model name, Running hour, Assest information, Location, Dept and etc.	●(Lite version) Compact information like S/N, Resolution, Model name and Running hour.
Instant Support	● SMS or Instant Message for individual users or public broadcasting	●(Lite version) Public broadcasting

SmartManage Features and Benefits

The Philips SmartManage is a working console for IT management to gather monitors assets information, run asset report, control assets security, monitor assets security, and issue instant messages to monitor users. Philips SmartManage includes the following major features:

1. Provides an additional security measure that helps corporate users safeguard their investment.
2. Power saving feature that reduces utility costs and manpower required to turn monitors on or off.
3. Provides an efficient means for adjusting monitor performance and settings.
4. Built-in asset reports reduce audit/maintenance manpower, cycle time and costs.

A trial version of SmartManage can be downloaded from

<http://www.altiris.com/philips>

You can also download SmartManage Lite

<http://www.portrait.com/dtune/phl/enu/index.html>



SmartManage is a software dedicated to business environments. Personal users normally do not need to use SmartManage.

Philips SmartManage is a solution joint developed by Philips and Altiris Inc.

Philips SmartControl II and SmartManage Lite is a solution joint developed by Philips and Portrait Display, Inc.

Philips SmartControl II

SmartControl II is monitor-based software with an easy-to-use on-screen graphic interface that guides you through fine-tuning resolution, color calibration and other display settings including brightness, contrast, clock & phase, position, RGB, white point and - on models with onboard speakers - volume adjustments. Monitors install SmartControl II can also have the ability to be managed by SmartManage which can manage PCs and Monitors or by SmartManage Lite which can manage Monitors. (Please refer to SmartManage/SmartManage Lite chapter) .

System support and requirement:

1. Sytem support: 2000, XP, NT 4.0, XP 64 Edition, Vista 32/64. IE Support 6.0/7.0.
2. Language support: English, Simplified Chinese, German, Spanish, French, Italian, Russian, Portuguese.
3. Philips Monitor support DDC/CI Interface.

Installation:

1. Installer – Install Shield Welcome

- Next Button takes user to next Install pane.
- Cancel prompts user if they want to cancel installation.



SmartControl II
Installer.exe

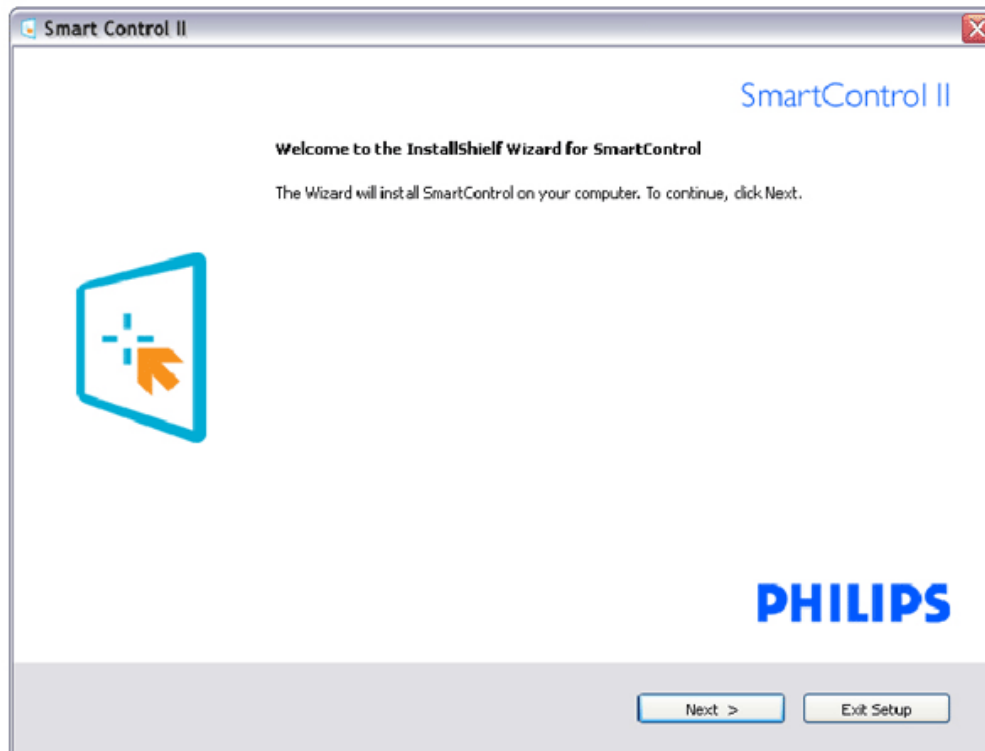

2. Installer – Install Shield Legal

- Choose "I accept" for installation process.
- Cancel prompts user if you want to cancel installation.



SmartControl II
Installer.exe

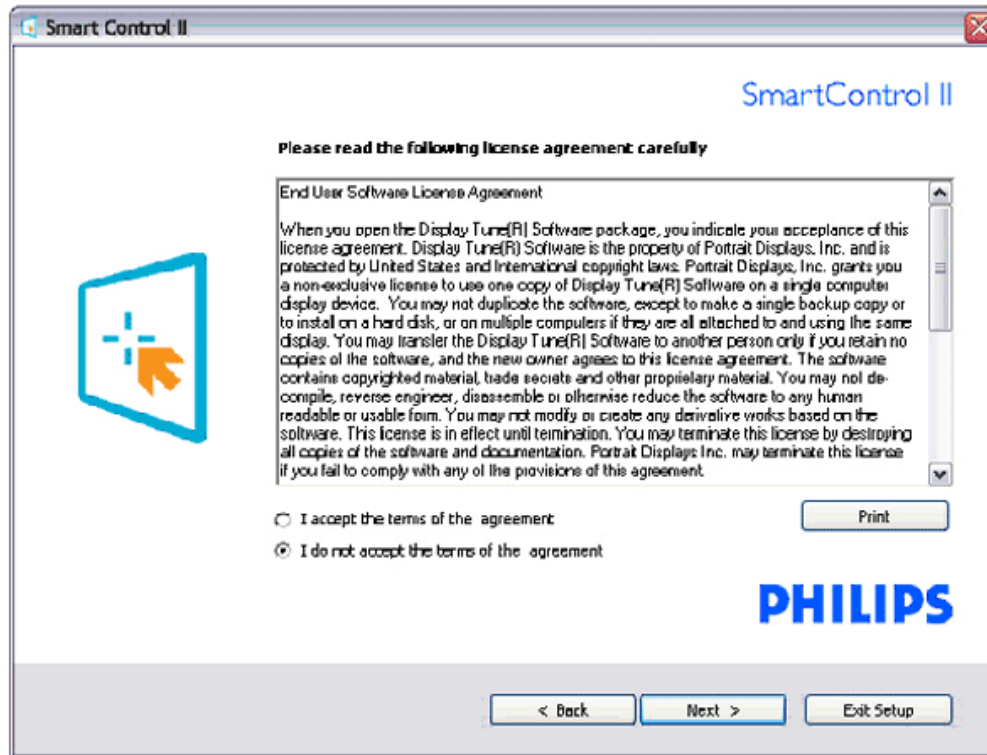

3. Installer – Install Shield Program Files

- Check the box if you wants to install SmartManage Lite Asset Management services.

Personal user usually not need to active this function. Read SmartManage section in this manual before you choose SmartManage Lite function.



SmartControl II
Installer.exe

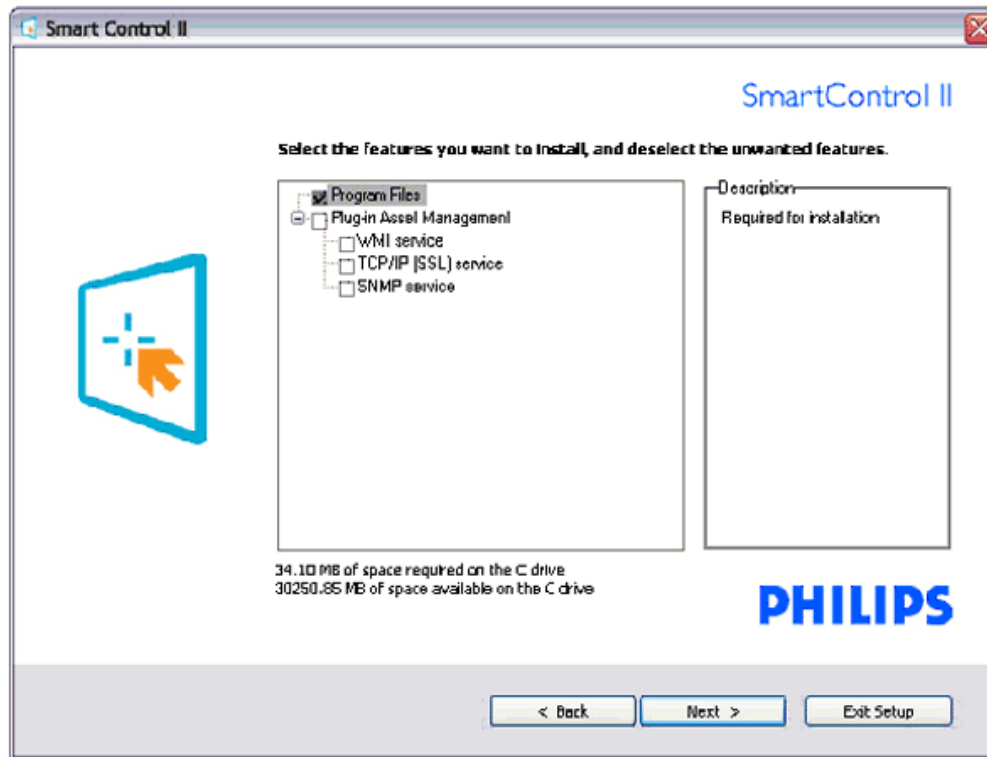

4. Installer – Installation Process

- Follow the instruction and complete the installation.
- You can launch after installation complete.
- If you want to launch later, you can either click the shortcut on desktop or toolbar.



SmartControl II
Installer.exe

Smart Control II

SmartControl II

Click Install to begin the installation

If you want to review or change any of your installation settings, click Back. Click Cancel to exit the wizard.

A logo consisting of a blue square with rounded corners, containing a white plus sign and an orange mouse cursor arrow pointing towards the bottom right corner.

PHILIPS

< Back Install Exit Setup



SmartControl II
Installer.exe

Smart Control II

SmartControl II

InstallShield Wizard Complete

The InstallShield Wizard has successfully installed SmartControl. Before you can use the program, you must restart your computer.



- Yes, I want to restart my computer now.
- No, I will restart my computer later.

Remove any disks from their drives, and then click Finish to complete setup.

PHILIPS

Finish

PHILIPS



SmartControl II

2007 Royal Philips Electronics
 Powered by Portrait
 Portions utilize Microsoft Windows Media Technologies.
 Copyright 1999-2002 Microsoft Corporation.
 All Rights Reserved.
 Copyright of Suppliers Acknowledged.

Start to use:

1. First launch –Wizard

- The first time after installation of SmartControl II, it will automatically go to Wizard for first time launch.
- The wizard will guide you through adjustment your monitor performance step by step.
- You can go to Plug-in menu to launch wizard later on as well.
- You can adjust more options without wizard by Standard pane.

Wizard Analog Sequence	Wizard Digital Sequence
Resolution	Resolution
Focus	Contrast
Brightness	Brightness
Contrast	White Point (Color Temp)
Position	File
White Point (Color Temp)	
File	

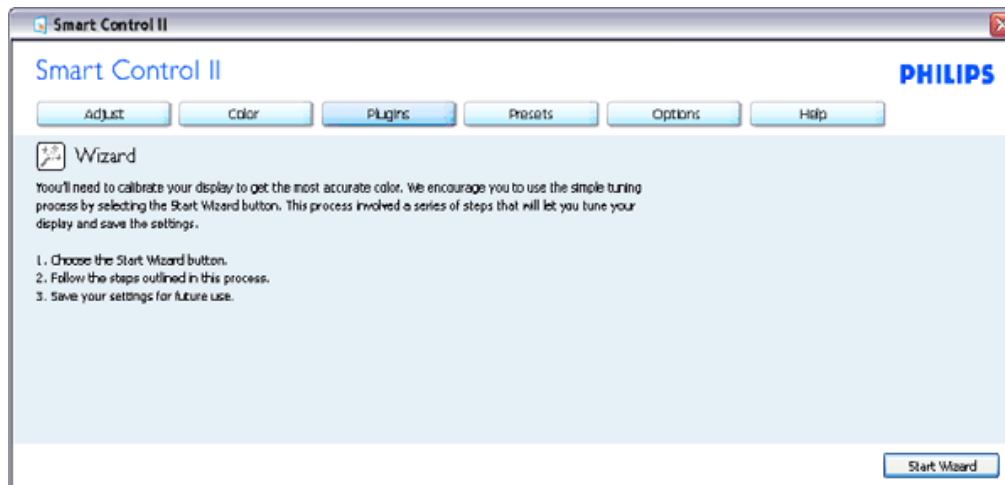

2. Start with Standard pane:

Adjust menu:

- Adjust Menu allow you to adjust Brightness, Contrast, Focus, Position and Resolution.
- You can follow the instruction and do the adjustment.
- Cancel prompts user if you want to cancel installation.

Tab Heading	Sub Menu	Display in Analog	Display in Digital
Adjust	Brightness	Yes	Yes
Adjust	Contrast	Yes	Yes
Adjust	Focus (Clock & Clock Phase)	Yes	No
Adjust	Position	Yes	No
Adjust	Resolution	Yes	Yes

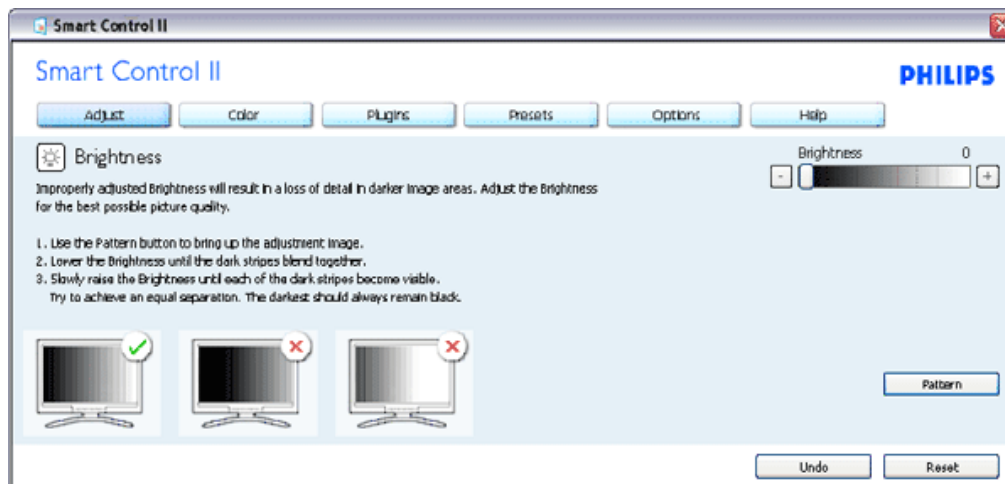

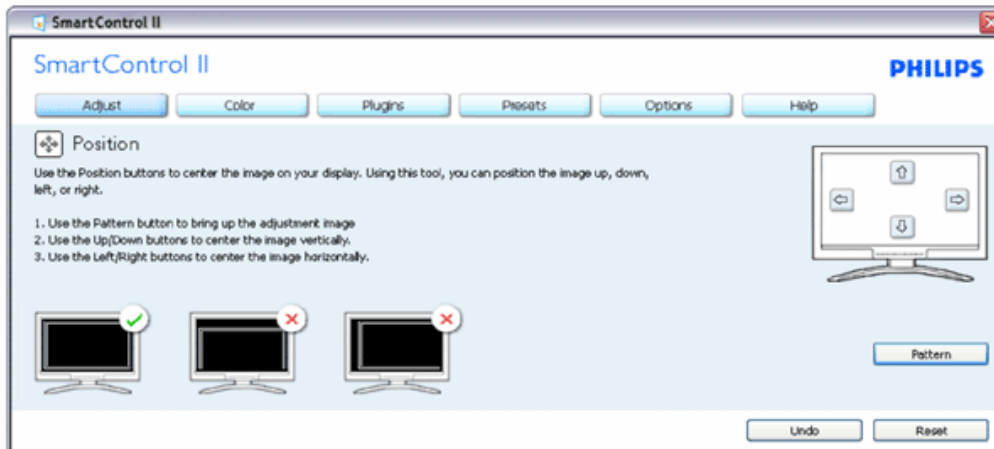
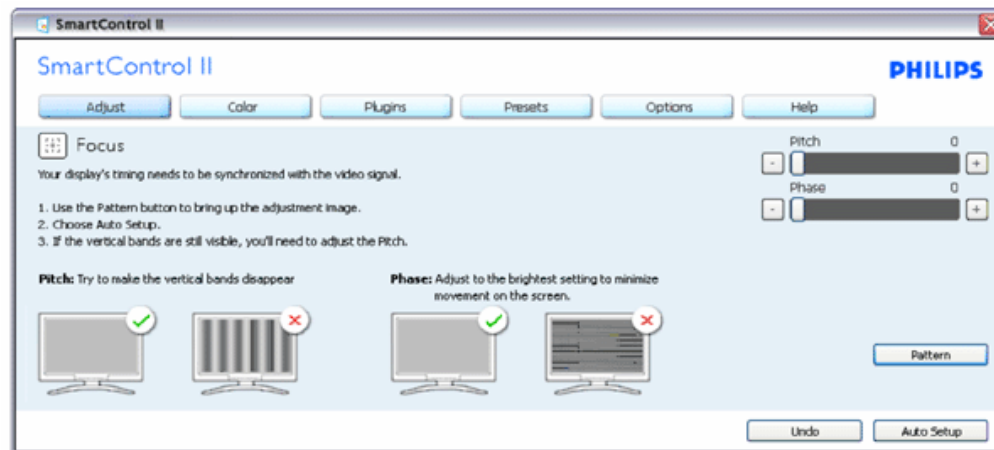
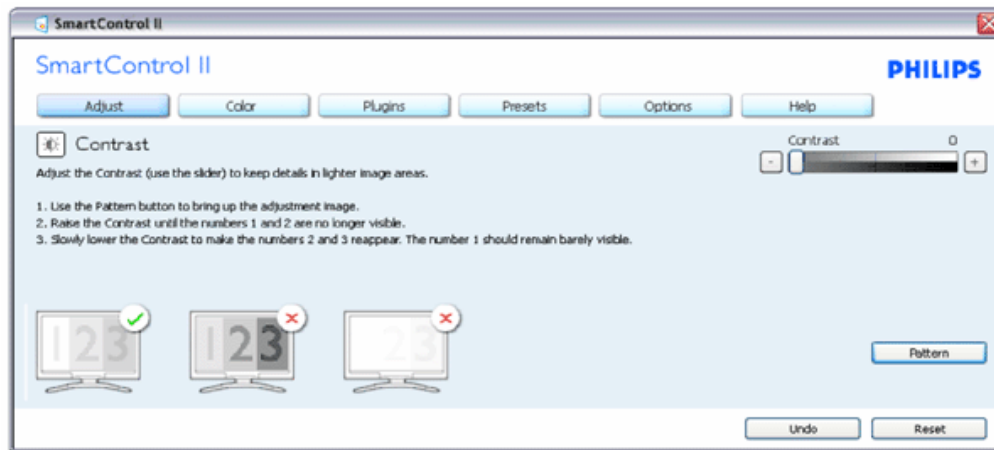

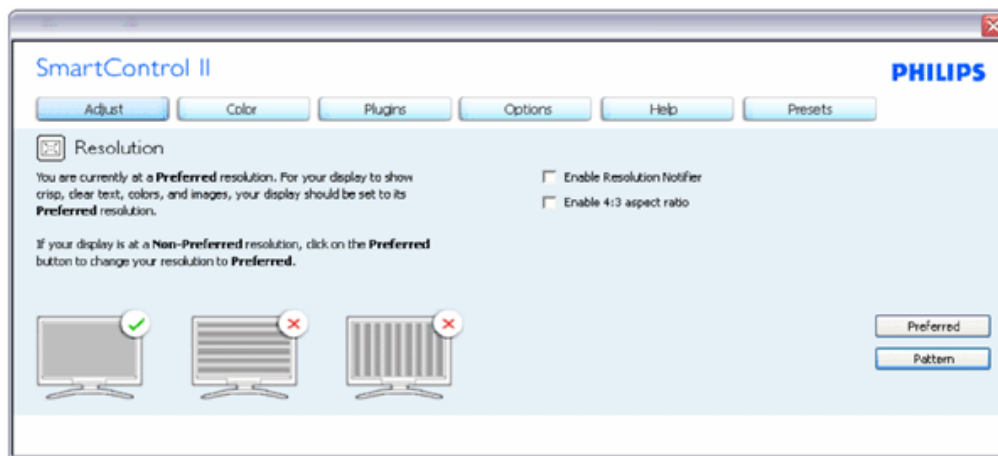

Color menu:

- Color Menu allow you to adjust RGB, Black Level, White Point, Color Calibration, and SmartImage (Please refer to SmartImage section).
- You can follow the instruction and do the adjustment.
- Refer to below table for sub-menu item base on your input.

Tab Heading	Sub Menu	Display in Analog	Display in Digital
Color	RGB	Yes	Yes
Color	Black Level	Yes	Yes
Color	White Point	Yes	Yes
Color	Color Calibration	Yes	Yes
Color	Viewing Mode	Yes	Yes

Example for Color Calibration



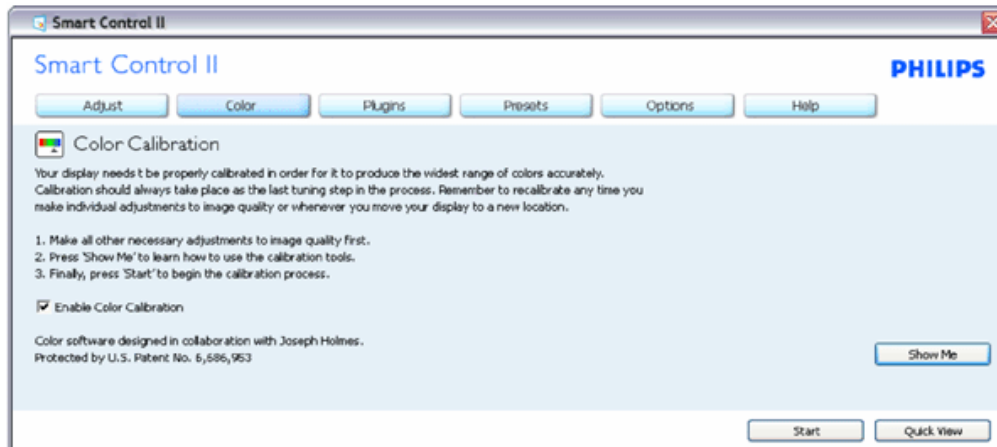
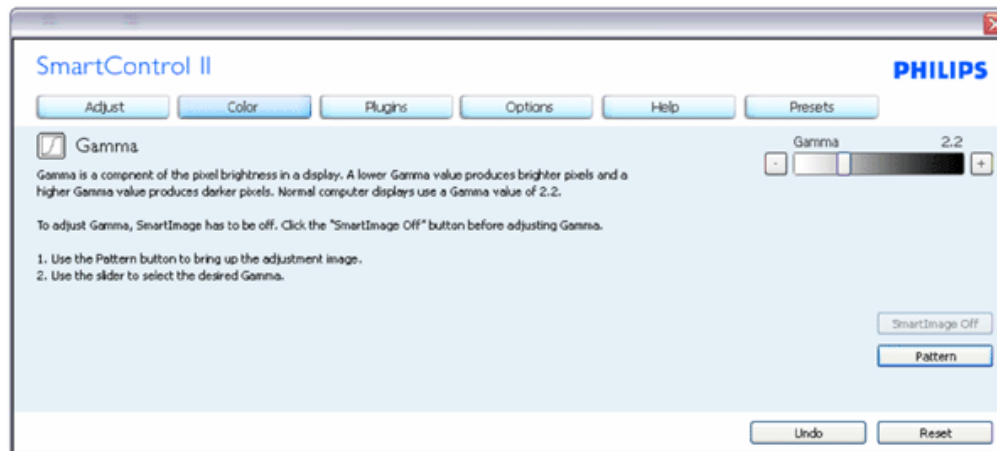
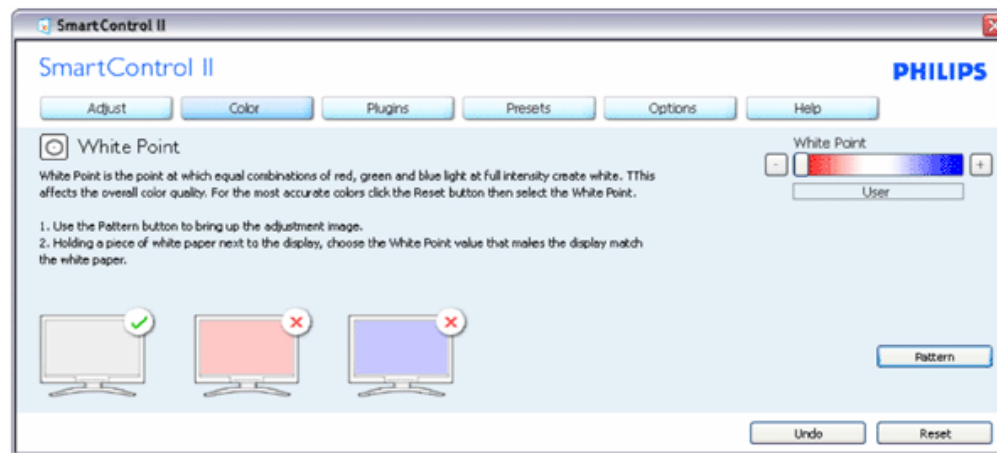

1. "Show Me" starts color calibration tutorial.
2. Start - starts the 6-step color calibration sequence.
3. Quick View loads the before/after images.

4. To return to Color home pane, click the Cancel button.
5. Enable color calibration - by default is on. If unchecked, does not allow for color calibration to happen, dimes out start and quick view buttons.
6. Must have patent info in calibration screen.

First color Calibration Screen:



1. Previous button is disabled until the second color screen.
2. Next goes to the succeeding target (6-targets).
3. Final next goes File>Presets pane.
4. Cancel closes the UI and returns to the plug in page.

SmartImage - Allows user to change setting for better display setting based on content.

When Entertainment is set, SmartContrast and SmartResponse are enabled.

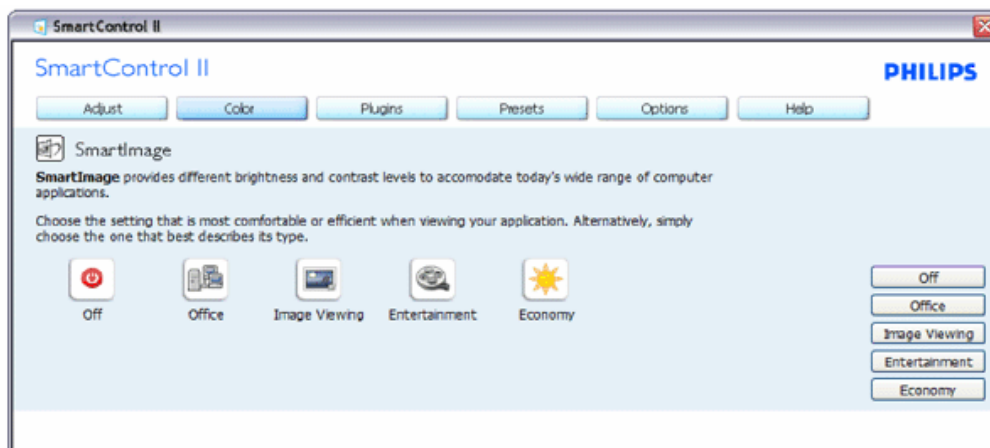

Plug-Ins - Asset Management Pane will only be active when selecting Asset Management from the drop-down Plug Ins menu.

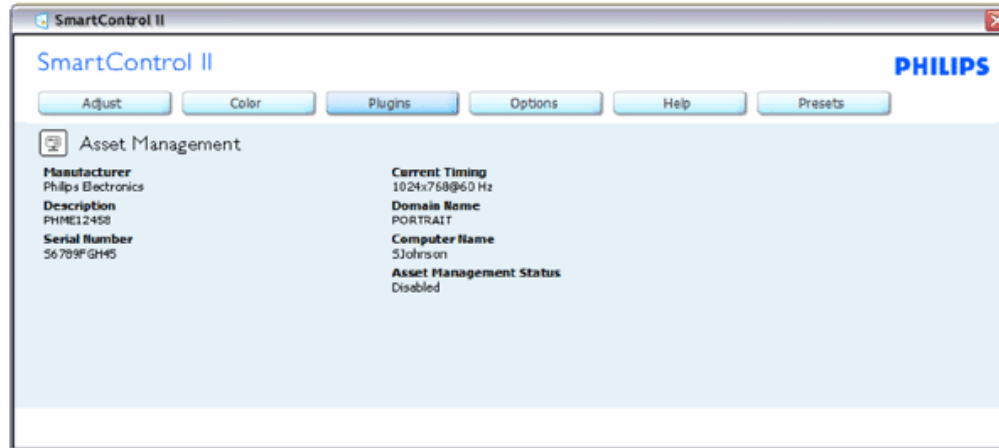

Displays Assent Management information on Managment, Description, Serial Number, Current Timing, Domain Name, and Asset Management Status.

To return to Plug-in home pane select the plug-in tab.

Plug-Ins - Theft Deterence Pane will only be active when selecting Theft from the drop-down Plug Ins menu.



To enable Theft Deterence, clicking Enable Theft button brings up the following screen:



1. User can enter PIN between 4 and 9 digits numbers only.
2. After entering PIN, Accept button takes user to the pop-up dialog box on the following page.
3. Minimum minutes set to 5. Slider set to 5 by default.
4. Does not require the display be attached to a different host to go into theft mode.

Once a PIN is entered and accepted, the following dialog box appears:

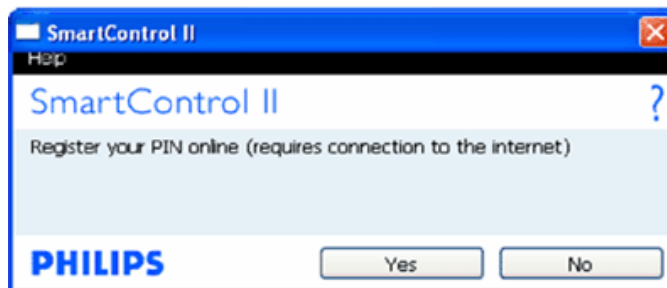

- Click on No button takes user to the following screen.

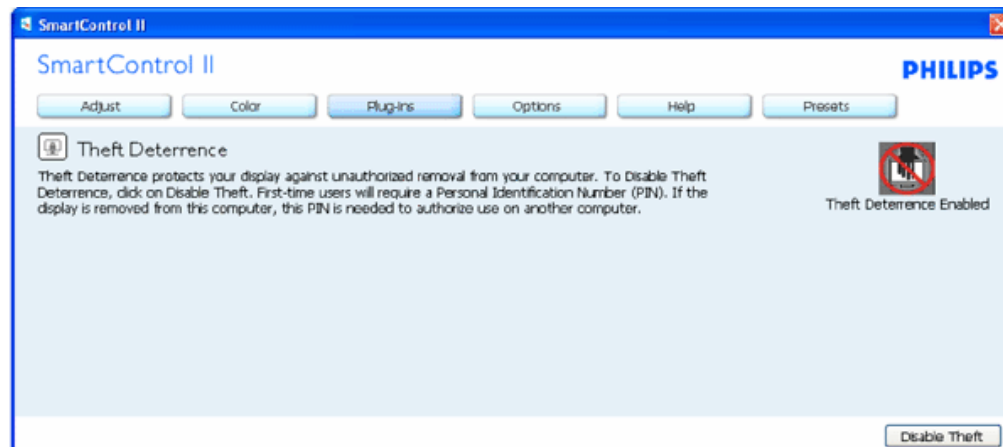

- Click on Yes button takes user to secure web site landing page.

After creating PIN, the Theft Deterrence pane will indicate Theft Deterrence Enabled and provide PIN Options button:

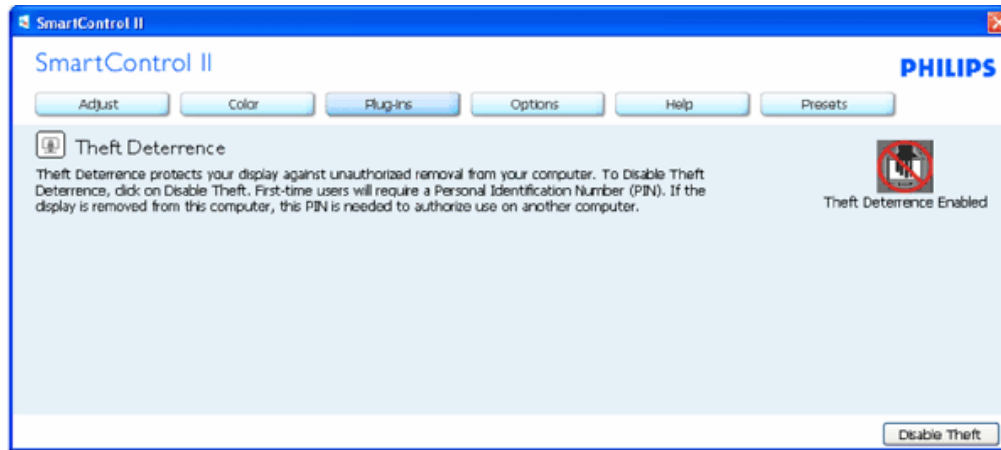

1. Theft Deterrence Enabled is displayed.
2. Disable Theft opens pane screen on next page.
3. PIN Options button only available after user creates PIN, button opens secure PIN web site.

Disable Theft button opens the following pane:



1. After entering PIN, Accept button disables PIN.
2. Cancel button opens up main Theft Deterrence pane, displaying Theft Deterrence Disabled. Enable Theft and PIN Options buttons.
3. Entering incorrect PIN results in the following dialog box:

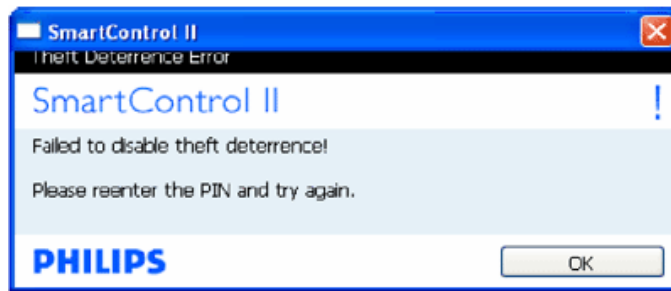

Options>Preferences - Will only be active when selecting Preferences from the drop-down Options menu. On a non-supported display capable of DDC/CI, only the Help and Options tabs are available.

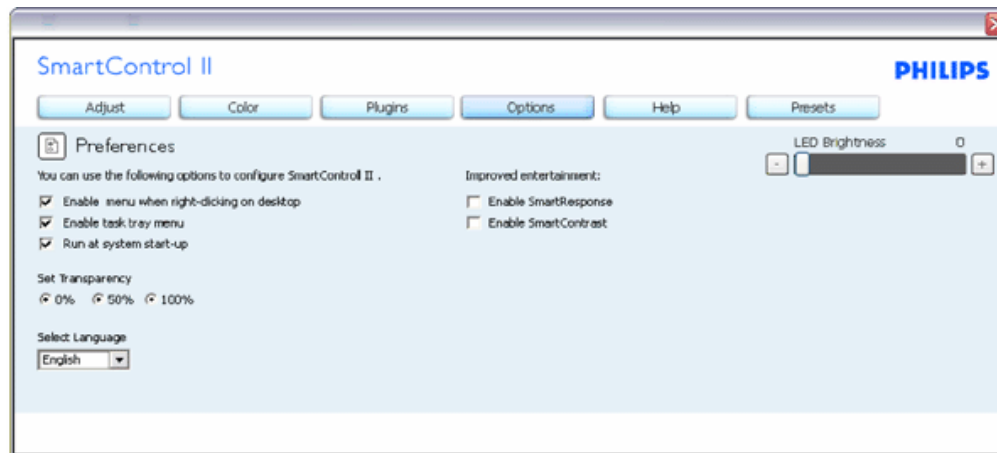

1. Displays current preference settings.
2. A checked box enables the feature. The check box is a toggle.
3. Enable Context Menu on desktop is checked (On) by default. Enable Context menu displays SmartControl II selections for Select Preset and Tune Display in the desktop right-click context menu. Disabled removes SmartControl II from the right click context menu.
4. Enable Task Tray icon is checked (On) by default. Enable context menu shows the task tray menu for SmartControl II. A right click on the task tray icon displays the menu options for Help, Technical Support. Check for Upgrade, About, and Exit. When Enable task tray menu is disabled, the task tray icon will only display EXIT.
5. Run at Startup is checked (On) by default. When disabled, SmartControl II will not launch at start or be in the task tray. The only way to launch SmartControl II is either from the desktop short cut or from the program file. Any preset set to run at startup will not load when this box is unchecked (Disabled).
6. Enable transparency mode (Vista, XP, and 2k only). Default is 0% Opaque.

Options>Input - Will only be active when selecting Input from the drop-down Options menu. On a non-supported display capable of DDC/CI, only the Help and Options tabs are available. All other SmartControl II tabs are not available.

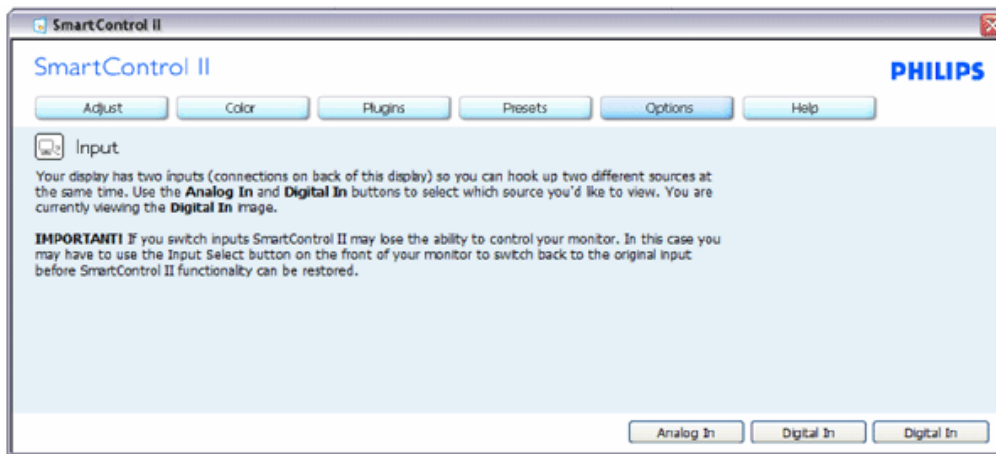

1. Display the Source instruction pane and current input source setting.
2. On single input displays, this pane will not be visible.

Options>Audio - Will only be active when selecting Volume from the drop-down Options menu. On a non-supported display capable of DDC/CI, only the Help and Options tabs are available.

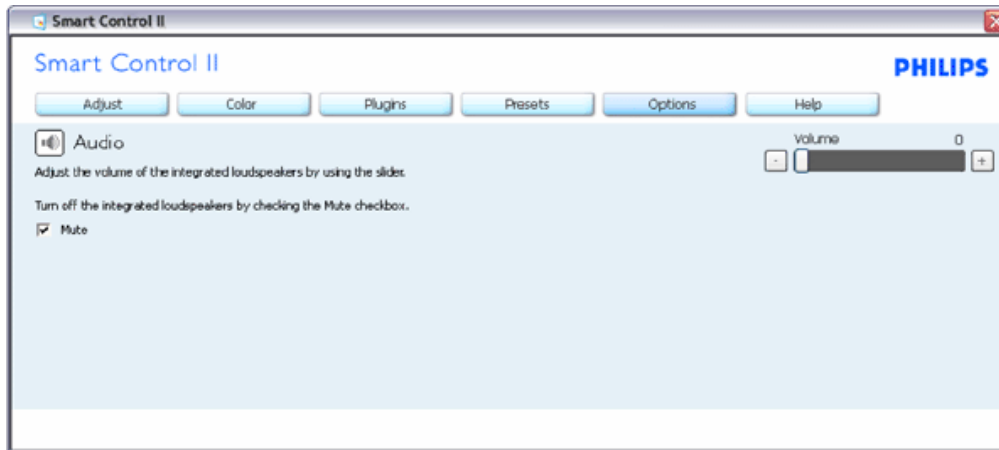

Option>Audio Pivot

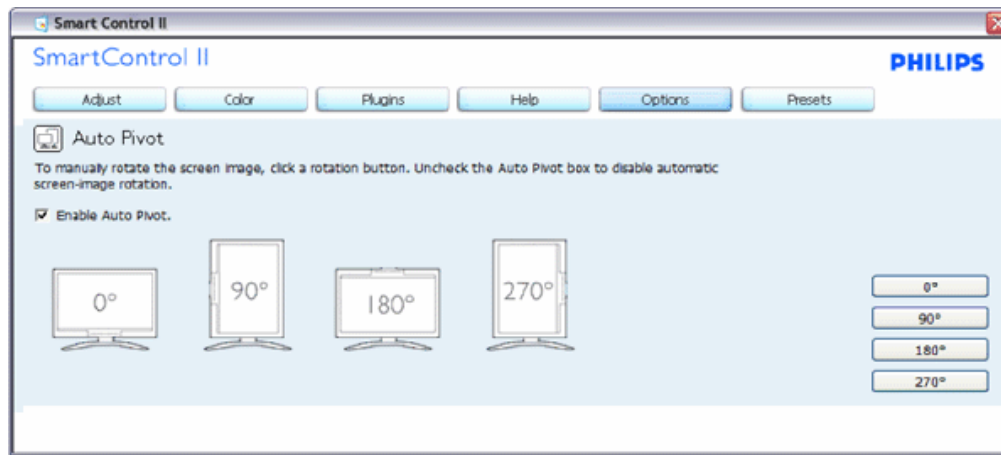

Help>User Manual - Will only be active when selecting User Manual from the drop-down Help menu. On a non-supported display capable of DDC/CI, only the Help and Options tabs are available.

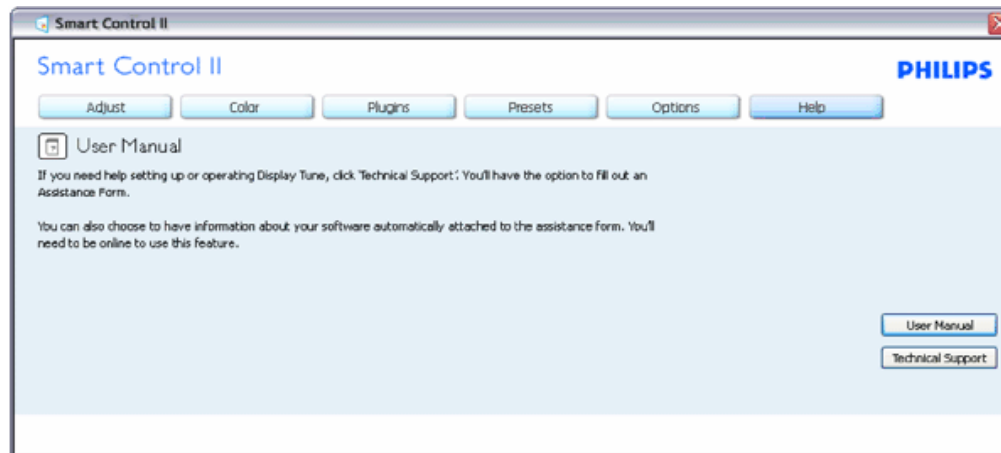

Help>Version - Will only be active when selecting Version from the drop-down Help menu. On a non-supported display capable of DDC/CI, only the Help and Options tabs are available.

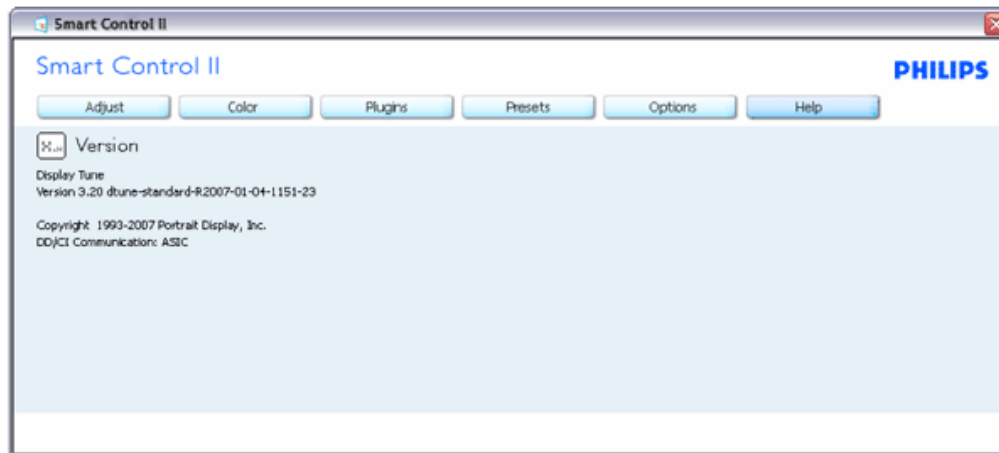

Context Sensitive menu

The Context Sensitive menu is Enabled by default. If Enable Context Menu has been checked in the Options>Preferences pane, then the menu will be visible.

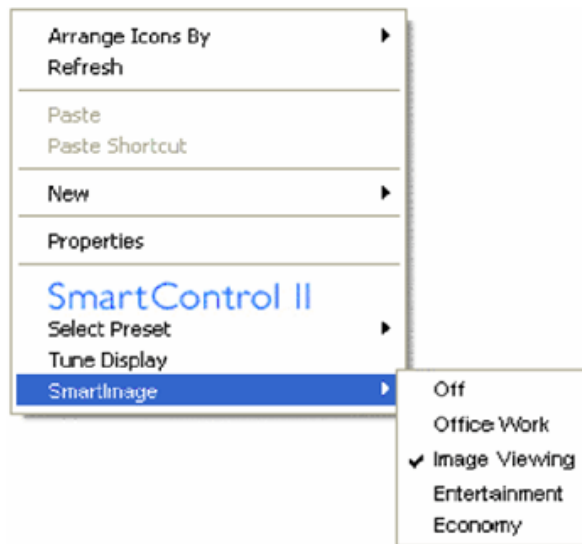

The Context Menu has four entries:

1. SmartControl II - When selected the About Screen is displayed.
2. Select Preset - Provides a hierarchical menu of saved presets for immediate use. A check mark shows the currently selected preset. Factory Preset can also be called from the drop down menu.
3. Tune Display - Opens the SmartControl II control panel.
4. Fly off for SmartImage - Check current settings, Off, Office Work, ImageViewing, Entertainment, Economy.

Task Tray Menu Enabled

The task tray menu can be displayed by right-clicking on the SmartControl II icon from the task tray. Left Click will launch the application.



The task tray has five entries:

1. Help - Access to User Manual file: opens User Manual file using the default browser window.
2. Technical Support - displays the tech support page.
3. Check for Update - takes the user to PDI Landing and checks the user's version against the most current available.
4. About - Displays detailed reference information: product version, release information, and product name.
5. Exit - Close SmartControl II. To run SmartControl II again either select SmartControl II from Program menu, double-click the desktop PC icon or restart the system.



Task Tray Menu Disabled

When the Task Tray is disabled in the preference folder, only the EXIT selection is available. To completely remove SmartControl II from the task tray, disable Run at Startup in Options>Preferences.

Q&A

Q1. What is the difference between SmartManage, SmartControl?

A. SmartManage is a remote management/control software for IT managers to manage monitors across the network

SmartControl is a control panel extension, which helps users to adjust monitor performances and settings by a software interface, instead of the hardware buttons at the front bezel of the monitors.

Q2. I change the monitor on a PC to a different one and the SmartControl becomes un-usable, what do I do?

A. Restart your PC and see if SmartControl can work. Otherwise, you will need to remove and re-install SmartControl to ensure proper driver is installed.

Q3. The SmartControl functions well at the beginning, but it is not workable, what can I do?

A. If the following actions were executed, the monitor driver may need to be re-installed.

- Change video graphic adaptor to another one
- Update video driver
- Activities on OS, such as service pack or patch
- Run Windows Update and updated monitor and/or video driver
- Windows was booted with the monitor power off or disconnected.

To find out, please right click My Computer and click on Properties->Hardware-> Device Manager.

If you see "Plug and Play Monitor" shows under Monitor, then you need to re-install. Simply remove SmartControl and re-install it.

Q4. After installing SmartControl, when clicking on SmartControl tab, nothing shows up after a while or a failure message shows, what happened?

A. It might be your graphic adaptor is not compatible with the SmartControl. If your graphic adaptor is one of the above mentioned brands, try to download the most updated graphic adaptor driver from corresponding companies web site. Install the driver. Remove SmartControl, and re-install it once more.

If it is still not working, we are sorry that the graphic adaptor is not supported. Please pay attention to Philips web site for any updated SmartControl driver available.

Q5. When I click on Product Information, only partial information is shown, what happened?

A. It might be your graphic card adaptor driver is not the most updated version which fully supporting DDC/CI interface. Please try to download the most updated graphic adaptor driver from corresponding companies web site. Install the driver. Remove SmartControl, and re-install it once more.

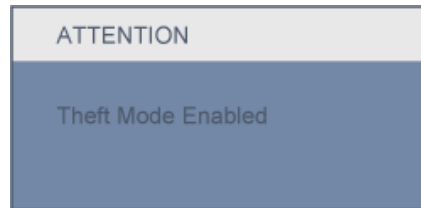

Q6. I forgot my PIN for Theft Deterrence Function. How can I do?

A. Please contact IT manager or Philips Service Center.

Q7. In a monitor with the SmartImage feature, the sRGB scheme of color temperature function in SmartControl is not responding, why?

A. When SmartImage is enabled, the sRGB scheme is disabled automatically. To use sRGB, you need to disable SmartImage with the  button at the front bezel of your monitor.

[RETURN TO TOP OF THE PAGE](#)

Front View Product Description

Connecting to Your PC

The Base





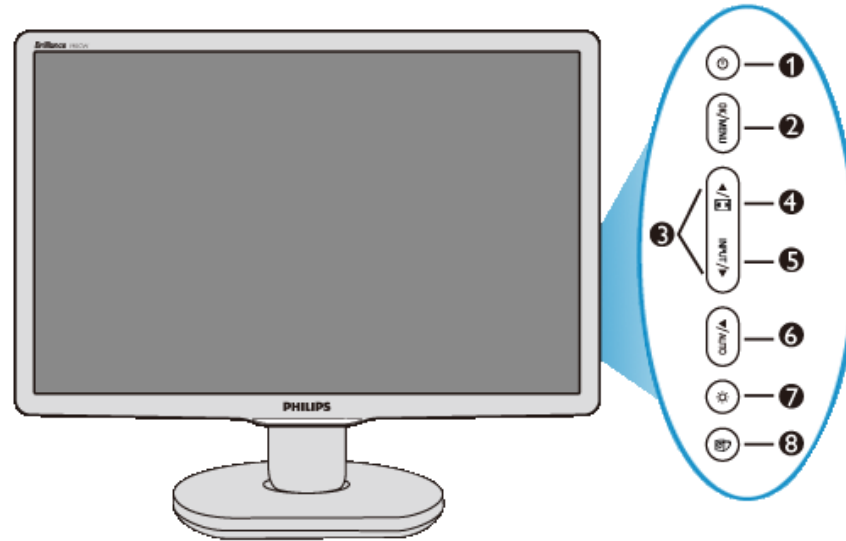

Getting Started

Optimizing Performance

Installing Your LCD Monitor

Front View Product Description



- | | | |
|---|--|---|
| 1 |  | To switch monitor's power On and Off |
| 2 | MENU / OK | To access the OSD menu |
| 3 |  | To adjust the OSD menu |
| 4 |  | Change to 4:3 display |
| 5 | Input | To change the signal input source. |
| 6 | AUTO /  | Automatically adjust the horizontal position, vertical position, phase and clock settings / Return to previous OSD level. |
| 7 |  | To adjust brightness of the display |
| 8 |  | SmartImage. There are five modes to be selected: Office Work, Image Viewing, Entertainment, Economy, and Off |

[RETURN TO TOP OF THE PAGE](#)

Rear View

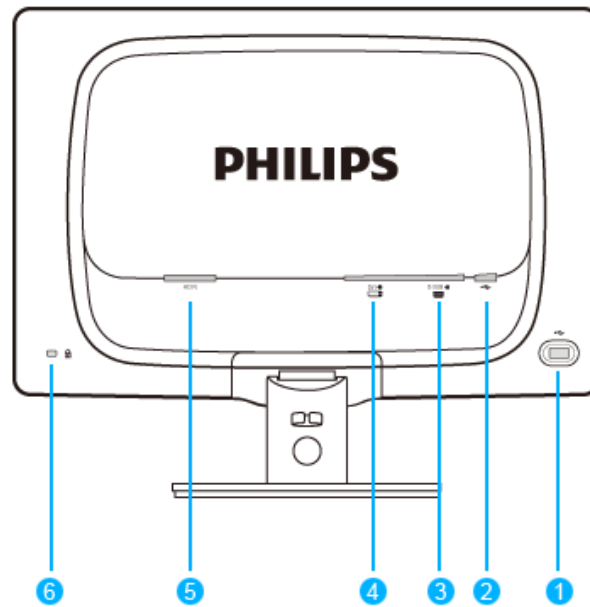

- 1 USB downstream port
- 2 USB upstream port
- 3 VGA input
- 4 DVI-D input (available for selective models)
- 5 AC power input
- 6 Kensington anti-thief lock

[RETURN TO TOP OF THE PAGE](#)

Optimizing Performance

- For best performance, ensure that your display settings are set at 1680x1050, 60Hz.



Note: You can check the current display settings by pressing the 'OK' button once. The current display mode is shown in OSD main controls called **RESOLUTION**.

[RETURN TO TOP OF THE PAGE](#)

Front View Product
Description
Accessory Pack

Connecting to Your PC
Getting Started

Optimizing Performance
The base

Connecting to Your PC

Accessory Pack

Unpack all the parts.



Power cord

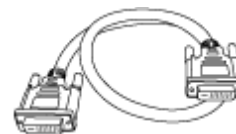

DVI cable (Optional)



VGA cable



EDFU pack

[RETURN TO TOP OF THE PAGE](#)

Connecting to Your PC

- 1) Connect the power cord to the back of the monitor firmly. (Philips has pre-connected VGA cable for the first installation.)

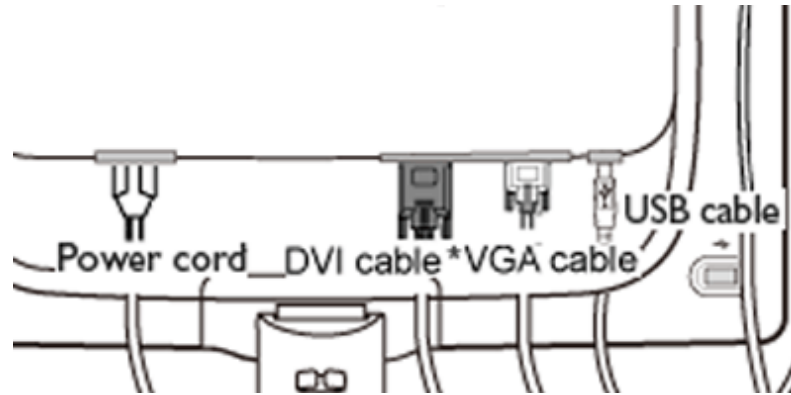

**available for selective models*

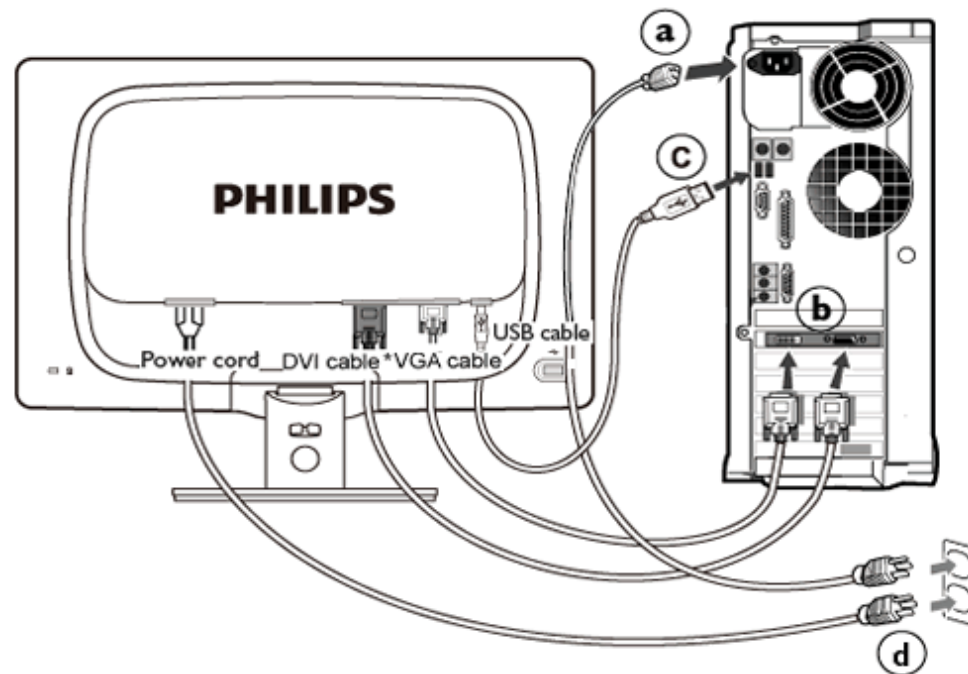

**available for selective models*

2) Connect to PC

- (a) Turn off your computer and unplug its power cable.
- (b) Connect the monitor signal cable to the video connector on the back of your computer.
- (c) Connect the USB cable to the USB port of your computer.
- (d) Plug the power cord of your computer and your monitor into a nearby outlet.
- (e) Turn on your computer and monitor. If the monitor displays an image, installation is complete.

[RETURN TO TOP OF THE PAGE](#)

[Front View Product Description](#)
[Accessory Pack](#)

[Connecting to your PC](#)
[Getting Started](#)

[Optimizing Performance](#)

[Attach the Base Stand](#)

[Detach the Base Stand](#)

The Base

Attach the Base Stand

1) Place the monitor face down on a smooth surface taking care to avoid scratching or damaging the screen.

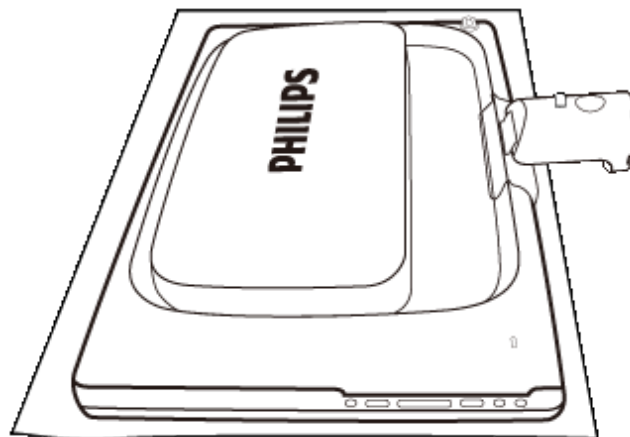

2) Hold the monitor base with both hands and firmly insert the base stand into the base column.

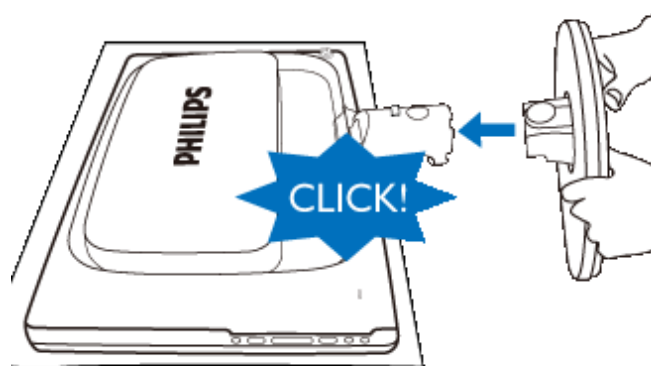

[RETURN TO TOP OF THE PAGE](#)

Detach the Base Stand

Place the monitor face on a safe surface, push down on the release button and pull the base stand away from the monitor body.

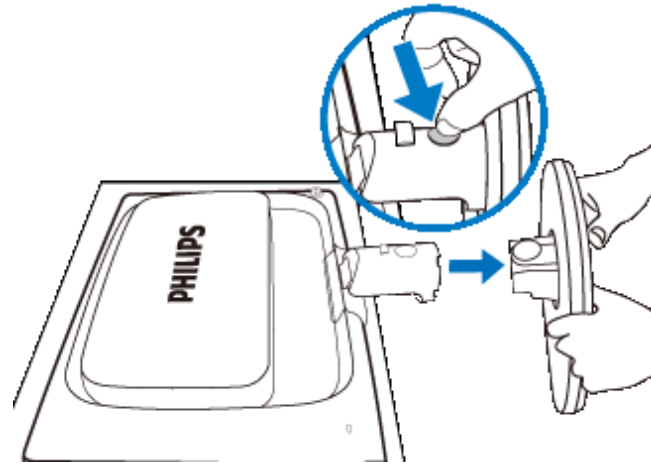

[RETURN TO TOP OF THE PAGE](#)

Your LCD Monitor :

Front View Product
Description
Setting Up and Connecting
Your Monitor
Getting Started

Optimizing Performance

Getting Started

Getting Started

Use the information file (.inf) for Windows® 98/2000/XP/Vista or later

The built-in VESA DDC2B feature in Philips Monitors supports Plug & Play requirements for Windows® 98/2000/XP/Vista. This information file (.inf) should be installed in order that your Philips monitor can be enabled from the 'Monitor' dialog box in Windows® 98/2000/XP/Vista and the Plug & Play application can be activated. The installation procedure based on Windows® 98, 2000, XP and Vista is specified as follows.

For Windows® 98

1. Start Windows® 98
2. Click on the 'Start' button, point to 'Settings', and then click on 'Control Panel'.
3. Double click on the 'Display' Icon.
4. Select the 'Settings' tab then click on 'Advanced...'
5. Select the 'Monitor' button, point to 'Change...' then click on 'Next'
6. Select 'Display a list of all the drivers in a specific location, so you can choose the driver you want.' then click on 'Next' and then click on 'Have Disk...'
7. Click on the 'Browse...' button, select the appropriate drive F: (CD-ROM Drive) then click on the 'OK' button.
8. Click on the 'OK' button then select your monitor model and click on the 'Next' button.
9. Click on the 'Finish' button then the 'Close' button.

For Windows® 2000

1. Start Windows® 2000.
2. Click on the 'Start' button, point to 'Settings', and then click on 'Control Panel'.
3. Double click on the 'Display' Icon.
4. Select the 'Settings' tab then click on 'Advanced...'
5. Select 'Monitor'
 - If the 'Properties' button is inactive, it means your monitor is properly configured. Please stop installation.
 - If the 'Properties' button is active. Click on 'Properties' button. Please follow the steps given below.
6. Click on 'Driver' and then click on 'Update Driver...' then click on the 'Next' button.
7. Select 'Display a list of the known drivers for this device so that I can choose a specific driver', then click on 'Next' and then click on 'Have disk...'
8. Click on the 'Browse...' button then select the appropriate drive F: (CD-ROM Drive).
9. Click on the 'Open' button, then click on the 'OK' button.

10. Select your monitor model and click on the 'Next' button.
11. Click on the 'Finish' button then the 'Close' button.
If you can see the 'Digital Signature Not Found' window, click on the 'Yes' button.

For Windows® XP

1. Start Windows® XP.
2. Click on the 'Start' button and then click on 'Control Panel'.
3. Select and click on the category 'Printers and Other Hardware'
4. Click on the 'Display' Item.
5. Select the 'Settings' tab then click on the 'Advanced' button.
6. Select 'Monitor' tab
 - If the 'Properties' button is inactive, it means your monitor is properly configured. Please stop installation.
 - If the 'Properties' button is active, click on 'Properties' button.Please follow the steps below.
7. Click on the 'Driver' tab and then click on 'Update Driver...' button.
8. Select the 'Install from a list or specific location [advanced]' radio button and then click on the 'Next' button.
9. Select the 'Don't Search. I will choose the driver to install' radio button. Then click on the 'Next' button.
10. Click on the 'Have disk...' button, then click on the 'Browse...' button and then select the appropriate drive F: (CD-ROM Drive).
11. Click on the 'Open' button, then click the 'OK' button.
12. Select your monitor model and click on the 'Next' button.
 - If you can see the 'has not passed Windows® Logo testing to verify its compatibility with Windows® XP' message, please click on the 'Continue Anyway' button.
13. Click on the 'Finish' button then the 'Close' button.
14. Click on the 'OK' button and then the 'OK' button again to close the Display_Properties dialog box.

For Windows® Vista

1. Start Windows® Vista.
2. Click the Start button; select and click on 'Control Panel'.
3. Select and click on 'Hardware and Sound'
4. Choose 'Device Manager' and Click on 'Update device drivers'.
5. Select 'Monitor' and then right click on 'Generic PnP Monitor'.
6. Click on 'Update Driver Software'.
7. Select 'Browse my computer for driver software'.
8. Click the 'Browse' button and choose the drive in which you've placed the disk. Example: (CD-ROM Drive:\\Lcd\\PC\\drivers\\).
9. Click the 'Next' button.
10. Wait few minutes for installing the driver, and then click 'Close' button.

If your Windows® 98/2000/XP/Vista version is different or you need more detailed installation information, please refer to your Windows® 98/2000/XP/Vista user's manual.

[RETURN TO TOP OF THE PAGE](#)

Description of the On-Screen Display
The OSD Tree

On-Screen Display

Description of the On Screen Display

What is the On-Screen Display?

On-Screen Display (OSD) is a feature in all Philips LCD monitors. It allows an end user to adjust screen performance or select functions of the monitors directly through an on-screen instruction window. A user friendly on screen display interface is shown as below :

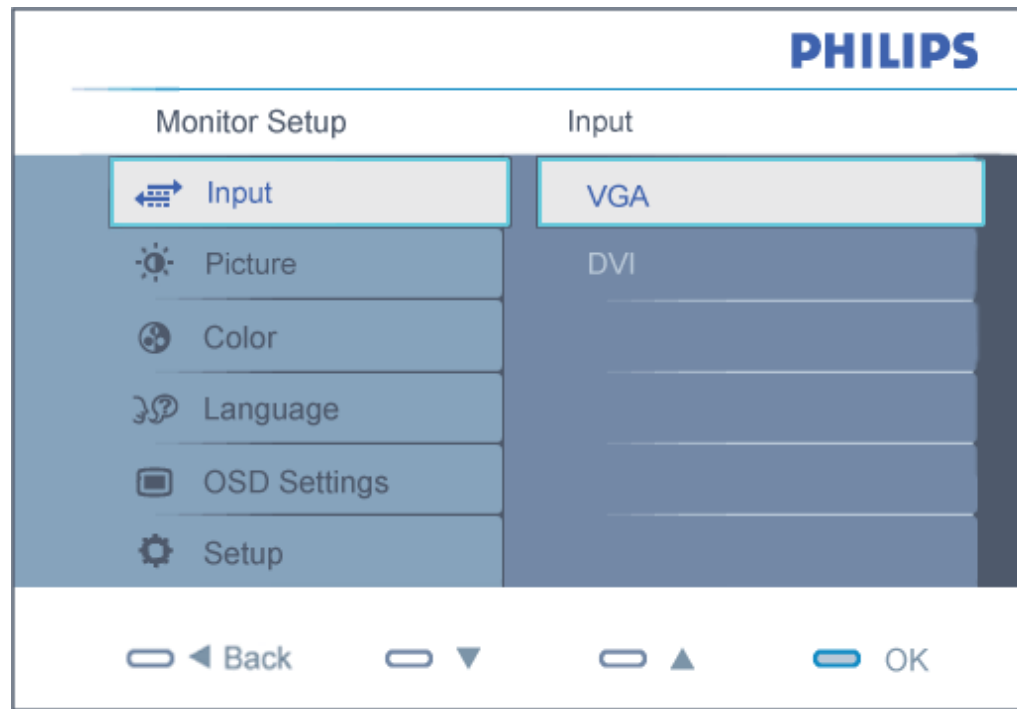

Basic and simple instruction on the control keys.

In the OSD shown above users can press ▼▲ buttons at the front bezel of the monitor to move the cursor, **OK** to confirm the choice or change.

[RETURN TO TOP OF THE PAGE](#)

The OSD Tree

Below is an overall view of the structure of the On-Screen Display. You can use this as a reference when you want to work your way around the different adjustments later on.

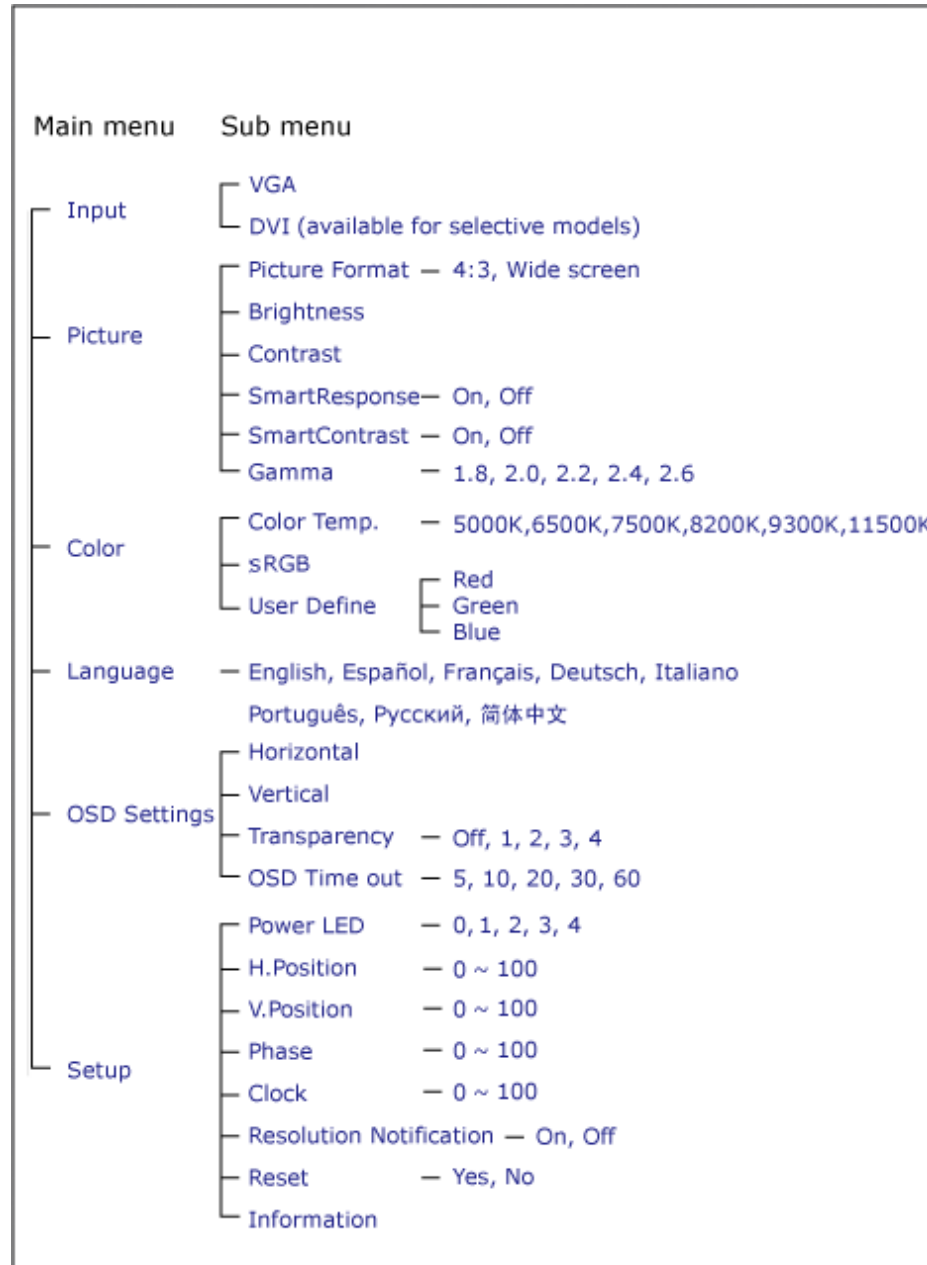

Resolution notification

This monitor is designed for optimal performance at its native resolution, 1680X1050@60Hz. When the monitor is powered on at a different resolution, an alert is displayed on screen: Use 1680x1050@60Hz for best results.

Display of the native resolution alert can be switched off from Setup in the OSD (On Screen Display) menu.

[RETURN TO TOP OF THE PAGE](#)

Customer Care & Warranty

PLEASE SELECT YOUR COUNTRY/AREA TO REVIEW DETAILS OF YOUR WARRANTY COVERAGE

WESTERN EUROPE: Austria Belgium Denmark France Germany Greece Finland Ireland Italy Luxembourg the Netherlands Norway Portugal Sweden Switzerland Spain United Kingdom

EASTERN EUROPE: Czech Republic Hungary Poland Russia Slovakia Slovenia Turkey

LATIN AMERICA: Antilles Argentina Brasil Chile Colombia Mexico Paraguay Peru Uruguay Venezuela

NORTH AMERICA: Canada USA

PACIFIC: Australia New Zealand

ASIA: Bangladesh China Hong Kong India Indonesia Japan Korea Malaysia Pakistan Philippines Singapore Taiwan Thailand

AFRICA: Morocco South Africa

MIDDLE EAST: Dubai Egypt

Your Philips F1rst Choice Warranty

Thank you for purchasing this Philips monitor.



All Philips monitors are designed and manufactured to high standards and deliver high-quality performance, ease of use and ease of installation. Should you encounter any difficulties while installing or using this product, please contact the Philips helpdesk directly to benefit from your Philips F1rst Choice Warranty. This three-year service warranty entitles you to a swap model on-site if your monitor turns out to be faulty or defective. Philips aims at a swap within 48 hours of your call being received.

What is covered?

The Philips F1rst Choice Warranty applies within Andorra, Austria, Belgium, Cyprus, Denmark, France, Germany, Greece, Finland, Ireland, Italy, Liechtenstein, Luxembourg, Monaco, the Netherlands, Norway, Poland, Portugal, Sweden, Switzerland, Spain and the United Kingdom and only for monitors originally designed, manufactured, approved and/or authorized for usage within these countries.

Warranty coverage begins as from the day you buy your monitor. *For three years thereafter*, your monitor will be swapped by at least an equivalent monitor in case of defects provided for under the warranty coverage.

The swap monitor remains yours and Philips keeps the defective/original monitor. For the swap monitor the warranty period remains equal to that of your original monitor, being 36 months as from the purchase date of your original monitor.

What is excluded?

The Philips F1rst Choice Warranty applies provided the product is handled properly for its intended use, in accordance with its operating instructions and upon presentation of the original invoice or cash receipt, indicating the date of purchase, dealer's name and model and production number of the product.

The Philips F1rst Choice Warranty may not apply if:

- The documents have been altered in any way or made illegible;
- The model or production number on the product has been altered, deleted, removed or made illegible;
- Repairs or product modifications and alterations have been executed by unauthorized service organizations or persons;
- Damage is caused by accidents including but not limited to lightning, water or fire, misuse or neglect;

- Reception problems caused by signal conditions or cable or antenna systems outside the unit;
- Defects caused by abuse or misuse of the monitor;
- Product requires modification or adaptation to enable it to comply with local or national technical standards, which apply in countries for which the product was not originally designed, manufactured, approved and/or authorized. Therefore always check whether a product can be used in a specific country.
- Note that products that are not originally designed, manufactured, approved and/or authorized for usage within the Philips F1rst Choice countries, do not apply to the Philips F1rst Choice Warranty. In these cases the Philips global warranty terms are valid.

Just a click away

In case of any problems, we advise you to read the operating instructions carefully or go to the www.philips.com/support website for additional support.

Just a phone call away

In order to avoid unnecessary inconvenience, we advise you to read the operating instructions carefully or go to the www.philips.com/support website for additional support before contacting the Philips helpdesk.

To solve your problem quickly, please prepare the following details before contacting the Philips helpdesk:

- Philips type number
- Philips serial number
- Purchase date (copy of purchase may be required)
- PC environment Processor:
 - 286/386/486/Pentium Pro/Internal memory
 - Operating system (Windows, DOS, OS/2, Apple Macintosh)
 - Fax/Modem/Internet program?
- Other cards installed

Having the following information available will also help speed up the process:

- Your proof of purchase indicating: date of purchase, dealer name, model and product serial number.
- The full address to which the faulty monitor has to be collected and the swap model should be delivered.

Philips' customer help desks are located worldwide. Click here to access the [F1rst Choice Contact Information](#).

Or you can reach us via:

Website: <http://www.philips.com/support>

First Choice Contact Information

Country	Code	Telephone number	Tariff
Austria	+43	0810 000206	€ 0.07
Belgium	+32	078 250851	€ 0.06
Denmark	+45	3525 8761	Local call tariff
Finland	+358	09 2290 1908	Local call tariff
France	+33	082161 1658	€ 0.09
Germany	+49	01803 386 853	€ 0.09
Greece	+30	00800 3122 1223	Free of charge
Ireland	+353	01 601 1161	Local call tariff
Italy	+39	840 320 041	€ 0.08
Luxembourg	+352	26 84 30 00	Local call tariff
The Netherlands	+31	0900 0400 063	€ 0.10
Norway	+47	2270 8250	Local call tariff
Poland	+48	0223491505	Local call tariff
Portugal	+351	2 1359 1440	Local call tariff
Spain	+34	902 888 785	€ 0.10
Sweden	+46	08 632 0016	Local call tariff
Switzerland	+41	02 2310 2116	Local call tariff
United Kingdom	+44	0207 949 0069	Local call tariff

Your Guarantee in Central and Eastern Europe

Dear Customer,

Thank you for purchasing this Philips product, which has been designed and manufactured to the highest quality standards. If, unfortunately, something should go wrong with this product Philips guarantees free of charge labor and replacement parts during a period of 36 months from date of purchase.

What is covered?

This Philips Guarantee in Central and Eastern Europe applies within Czech Republic, Hungary, Slovakia, Slovenia, Russia and Turkey and only for monitors originally designed, manufactured, approved and/or authorized for usage within these countries.

Warranty coverage begins as from the day you buy your monitor. *For 3 years thereafter*, your monitor will be serviced in case of defects provided for under the warranty coverage.

What is excluded?

The Philips guarantee applies provided the product is handled properly for its intended use, in accordance with its operating instructions and upon presentation of the original invoice or cash receipt, indicating the date of purchase, dealer's name and model and production number of the product.

The Philips guarantee may not apply if:

- the documents have been altered in any way or made illegible;
- the model or production number on the product has been altered, deleted, removed or made illegible;
- repairs or product modifications and alterations have been executed by unauthorized service organizations or persons;
- damage is caused by accidents including but not limited to lightning, water or fire, misuse or neglect.
- Reception problems caused by signal conditions or cable or antenna systems outside the unit;
- Defects caused by abuse or misuse of the monitor;
- Product requires modification or adaptation to enable it to comply with local or national technical standards, which apply in countries for which the product was not originally designed, manufactured, approved and/or authorized. Therefore always check whether a product can be used in a specific country.

Please note that the product is not defective under this guarantee in the case where modifications

become necessary in order for the product to comply with local or national technical standards which apply in countries for which the product was not originally designed and/or manufactured. Therefore always check whether a product can be used in a specific country.

Just a click away

In case of any problems, we advise you to read the operating instructions carefully or go to the www.philips.com/support website for additional support.

Just a phone call away

In order to avoid unnecessary inconvenience, we advise you to read the operating instructions carefully before contacting our dealers or Information Centers

In case your Philips product is not working correctly or is defective, please contact your Philips dealer or directly the [Philips Service and Consumer Information Centers](#)

Website: <http://www.philips.com/support>

Consumer Information Centers

[Antilles](#) [Argentina](#) [Australia](#) [Bangladesh](#) [Brasil](#) [Canada](#) [Chile](#) [China](#) [Colombia](#) [Belarus](#)
[Bulgaria](#) [Croatia](#) [Czech Republic](#) [Estonia](#) [Dubai](#) [Hong Kong](#) [Hungary](#) [India](#) [Indonesia](#)
[Korea](#) [Latvia](#) [Lithuania](#) [Malaysia](#) [Mexico](#) [Morocco](#) [New Zealand](#) [Pakistan](#) [Paraguay](#)
[Peru](#) [Philippines](#) [Romania](#) [Russia](#) [Serbia & Montenegro](#) [Singapore](#) [Slovakia](#) [Slovenia](#)
[South Africa](#) [Taiwan](#) [Thailand](#) [Turkey](#) [Ukraine](#) [Uruguay](#) [Venezuela](#)

Eastern Europe

BELARUS

Technical Center of JV IBA
M. Bogdanovich str. 155
BY - 220040 Minsk
Tel: +375 17 217 33 86

BULGARIA

LAN Service
140, Mimi Balkanska Str.
Office center Translog
1540 Sofia, Bulgaria
Tel: +359 2 960 2360
www.lan-service.bg

CZECH REPUBLIC

General Consumer Information Center
800 142100

Xpectrum
Lu.ná 591/4
CZ - 160 00 Praha 6 Tel: 800 100 697
Email:info@xpectrum.cz
www.xpectrum.cz

CROATIA

Renoprom d.o.o.
Mlinska 5, Strmec
HR - 41430 Samobor
Tel: +385 1 333 0974

ESTONIA

FUJITSU SERVICES OU
Akadeemia tee 21G
EE-12618 Tallinn
Tel: +372 6519900
www.ee.invia.fujitsu.com

HUNGARY

General Consumer Information Center
0680018544 (Local call tariff)

Serware Szerviz
Vizimolnár u. 2-4
HU - 1031 Budapest
Tel: +36 1 2426331
Email: inbox@serware.hu
www.serware.hu

HUNGARY

General Consumer Information Center
0680018544 (Local call tariff)

Profi Service Center Ltd.
123 Kulso-Vaci Street ,
H-1044 Budapest (Europe Center)
Hungary

Tel: +36 1 814 8080
m.andras@psc.hu

LATVIA

ServiceNet LV
Jelgavas iela 36
LV - 1055 Riga,
Tel: +371 7460399
Email: serviss@servicenet.lv

LITHUANIA

ServiceNet LT
Gaiziunu G. 3
LT - 3009 KAUNAS
Tel: +370 7400088
Email: servisas@servicenet.lt
www.servicenet.lt

ROMANIA

Blue Ridge Int'l Computers SRL
115, Mihai Eminescu St., Sector 2
RO - 020074 Bucharest
Tel: +40 21 2101969

SERBIA & MONTENEGRO

Tehnicom Service d.o.o.
Viline vode bb
Slobodna zona Beograd , L12/4
Belgrade 11000
Tel. +381 11 2070 664
Serbia

SLOVAKIA

General Consumer Information Center
0800004551

Datalan Servisne Stredisko
Puchovska 8
SK - 831 06 Bratislava
Tel: +421 2 49207155
Email: servis@datalan.sk

SLOVENIA

PC HAND
Brezovce 10
SI - 1236 Trzin
Tel: +386 1 530 08 24
Email: servis@pchand.si

RUSSIA

Tel: +7 095 961-1111
Tel: 8-800-200-0880
Website: www.philips.ru

TURKEY

Türk Philips Ticaret A.S.
Yukari Dudullu Org.San.Bolgesi
2.Cadde No:22
34776-Umraniye/Istanbul
Tel: (0800)-261 33 02

UKRAINE

Comel
Shevchenko street 32
UA - 49030 Dnepropetrovsk
Tel: +380 562320045
www.csp-comel.com

Latin America

ANTILLES

Philips Antillana N.V.
Kaminda A.J.E. Kusters 4
Zeelandia, P.O. box 3523-3051
Willemstad, Curacao
Phone: (09)-4612799
Fax : (09)-4612772

ARGENTINA

Philips Antillana N.V.
Vedia 3892 Capital Federal
CP: 1430 Buenos Aires
Phone/Fax: (011)-4544 2047

BRASIL

Philips da Amazônia Ind. Elet. Ltda.
Rua Verbo Divino, 1400-São Paulo-SP
CEP-04719-002
Phones: 11 21210203 -São Paulo & 0800-701-0203-Other Regions without São Paulo City

CHILE

Philips Chilena S.A.
Avenida Santa Maria 0760
P.O. box 2687Santiago de Chile
Phone: (02)-730 2000
Fax : (02)-777 6730

COLOMBIA

Industrias Philips de Colombia
S.A.-Division de Servicio
CARRERA 15 Nr. 104-33
Bogota, Colombia
Phone:(01)-8000 111001 (toll free)
Fax : (01)-619-4300/619-4104

MEXICO

Consumer Information Centre
Norte 45 No.669
Col. Industrial Vallejo
C.P.02300, -Mexico, D.F.
Phone: (05)-3687788 / 9180050462
Fax : (05)-7284272

PARAGUAY

Av. Rca. Argentina 1780 c/Alfredo Seiferheld
P.O. Box 605
Phone: (595 21) 664 333
Fax: (595 21) 664 336
Customer Desk:
Phone: 009 800 54 1 0004

PERU

Philips Peruana S.A.
Customer Desk
Comandante Espinar 719
Casilla 1841
Limab18
Phone: (01)-2136200
Fax : (01)-2136276

URUGUAY

Rambla O'Higgins 5303 Montevideo
Uruguay
Phone: (598) 619 66 66
Fax: (598) 619 77 77
Customer Desk:
Phone: 0004054176

VENEZUELA

Industrias Venezolanas Philips S.A.
Apartado Postal 1167
Caracas 1010-A
Phone: (02) 2377575
Fax : (02) 2376420

Canada

CANADA

Philips Electronics Ltd.
281 Hillmount Road
Markham, Ontario L6C 2S3
Phone: (800) 479-6696

Pacific

AUSTRALIA

Philips Consumer Electronics
Consumer Care Center
Level 1, 65 Epping Rd
North Ryde NSW 2113
Phone: 1300 363 391
Fax : +61 2 9947 0063

NEW ZEALAND

Philips New Zealand Ltd.
Consumer Help Desk
2 Wagener Place, Mt.Albert
P.O. box 1041
Auckland
Phone: 0800 477 999 (toll free)
Fax : 0800 288 588

Asia

BANGLADESH

Philips Service Centre
100 Kazi Nazrul Islam
Avenue Kawran Bazar C/A
Dhaka-1215
Phone: (02)-812909
Fax : (02)-813062

CHINA

SHANGHAI
Rm 1007, Hongyun Building, No. 501 Wuning road,
200063 Shanghai P.R. China
Phone: 4008 800 008
Fax: 21-52710058

HONG KONG

Philips Electronics Hong Kong Limited
Consumer Service
Unit A, 10/F. Park Sun Building
103-107 Wo Yi Hop Road
Kwai Chung, N.T.
Hong Kong
Phone: (852)26199663
Fax: (852)24815847

INDIA

Phone: 91-20-712 2048 ext: 2765
Fax: 91-20-712 1558

BOMBAY

Philips India
Customer Relation Centre
Bandbox House
254-D Dr. A Besant Road, Worli
Bombay 400 025

CALCUTTA

Customer Relation Centre
7 justice Chandra Madhab Road
Calcutta 700 020

MADRAS

Customer Relation Centre
3, Haddows Road
Madras 600 006

NEW DELHI

Customer Relation Centre
68, Shivaji Marg
New Dehli 110 015

INDONESIA

Philips Group of Companies in Indonesia
Consumer Information Centre
Jl.Buncit Raya Kav. 99-100
12510 Jakarta
Phone: (021)-7940040 ext: 2100
Fax : (021)-794 7511 / 794 7539

KOREA

Philips Consumer Service
Jeong An Bldg. 112-2
Banpo-dong, Seocho-Ku
Seoul, Korea
Customer Careline: 080-600-6600
Phone: (02) 709-1200
Fax : (02) 595-9688

MALAYSIA

After Market Solutions Sdn Bhd,
Philips Authorised Service Center,
Lot 6, Jalan 225, Section 51A,
46100 Petaling Jaya,
Selangor Darul Ehsan,
Malaysia.
Phone: (603)-7954 9691/7956 3695
Fax: (603)-7954 8504
Customer Careline: 1800-880-180

PAKISTAN

Philips Consumer Service
Mubarak manzil,
39, Garden Road, Saddar,
Karachi-74400
Tel: (9221) 2737411-16
Fax: (9221) 2721167
E-mail: care@philips.com
Website: www.philips.com.pk

PHILIPPINES

PHILIPS ELECTRONICS & LIGHTING, INC.
Consumer Electronics
48F PBCOM tower
6795 Ayala Avenue cor VA Rufino St.
Salcedo Village
1227 Makati City, PHILS
Phone: (02)-888 0572, Domestic Toll Free: 1-800-10-PHILIPS or 1-800-10-744 5477
Fax: (02)-888 0571

SINGAPORE

Accord Customer Care Solutions Ltd
Authorized Philips Service Center
Consumer Service
620A Lorong 1 Toa Rayoh
Singapore 319762
Tel: +65 6882 3999
Fax: +65 6250 8037

TAIWAN

Philips Taiwan Ltd.
Consumer Information Centre
13F, No. 3-1 Yuan Qu St., Nan Gang Dist.,
Taipei 115, Taiwan
Phone: 0800-231-099
Fax : (02)-3789-2641

THAILAND

Philips Electronics (Thailand) Ltd.
26-28th floor, Thai Summit Tower
1768 New Petchburi Road
Khwaeng Bangkapi, Khet Huaykhwang
Bangkok10320 Thailand
Tel: (66)2-6528652
E-mail: cic Thai@philips.com

Africa

MOROCCO

Philips Electronique Maroc
304,BD Mohamed V
Casablanca
Phone: (02)-302992
Fax : (02)-303446

SOUTH AFRICA

PHILIPS SA (PTY) LTD
Customer Care Center
195 Main Road
Martindale, Johannesburg
P.O. box 58088
Newville 2114
Telephone: +27 (0) 11 471 5194
Fax: +27 (0) 11 471 5123
E-mail: customercare.za@philips.com

Middle East

DUBAI

Philips Middle East B.V.
Consumer Information Centre
P.O.Box 7785
DUBAI
Phone: (04)-335 3666
Fax : (04)-335 3999

Your International Guarantee

Dear Customer,

Thank you for purchasing this Philips product which has been designed and manufactured to the highest quality standards.

If, unfortunately, something should go wrong with this product Philips guarantees free of charge labor and replacement parts irrespective of the country where it is repaired during a period of 12 months from date of purchase. This international Philips guarantee complements the existing national guarantee obligations to you of dealers and Philips in the country of purchase and does not affect your statutory rights as a customer.

The Philips guarantee applies provided the product is handled properly for its intended use, in accordance with its operating instructions and upon presentation of the original invoice or cash receipt, indicating the date of purchase, dealer's name and model and production number of the product.

The Philips guarantee may not apply if:

- the documents have been altered in any way or made illegible;
- the model or production number on the product has been altered, deleted, removed or made illegible;
- repairs or product modifications and alterations have been executed by unauthorized service organizations or persons;
- damage is caused by accidents including but not limited to lightning, water or fire, misuse or neglect.

Please note that the product is not defective under this guarantee in the case where modifications become necessary in order for the product to comply with local or national technical standards which apply in countries for which the product was not originally designed and/or manufactured. Therefore always check whether a product can be used in a specific country.

In case your Philips product is not working correctly or is defective, please contact your Philips dealer. In the event you require service whilst in another country a dealer address can be given to you by the Philips Consumer Help Desk in that country, the telephone and fax number of which can be found in the relevant part of this booklet.

In order to avoid unnecessary inconvenience, we advise you to read the operating instructions carefully before contacting your dealer. If you have questions which your dealer cannot answer or any related question please contact the [Philips Consumer Information Centers](#) or via:

Website: <http://www.philips.com>

Your Philips F1rst Choice Warranty(USA)

Thank you for purchasing this Philips monitor.



All Philips monitors are designed and manufactured to high standards and deliver high-quality performance, ease of use and ease of installation. Should you encounter any difficulties while installing or using this product, please contact Philips directly to benefit from your Philips F1rst Choice Warranty. This three-year service warranty entitles you to a swap model on-site within 48 hours of your call being received within the first year of purchase. If you have any problems with your monitor within the second or third year of purchase, we will repair it after it has been sent to the service provider at your expense and returned to you within five working days, free of charge.

LIMITED WARRANTY (Computer Monitor)

Click here to access the [Warranty Registration Card](#).

Three Years Free Labor / Three Years Free Service on Parts / One Year Exchange*

**Product will be exchanged with a new or renewed to original specifications unit within two business days for the first year. This product must be shipped in at your expense for service during years two and three.*

WHO IS COVERED?

You must have proof of purchase to receive warranty service. A sales receipt or other document showing that you purchased the product is considered proof of purchase. Attach it to this owner's manual and keep both nearby.

WHAT IS COVERED?

Warranty coverage begins the day you buy your product. *For three years thereafter*, all parts will be repaired or replaced, and labor is free. *After three years from the day of purchase*, you pay for the replacement or repair of all parts, and for all labor charges.

All parts, including repaired and replaced parts, are covered only for the original warranty period. When the warranty on the original product expires, the warranty on all replaced and repaired products and parts also expires.

WHAT IS EXCLUDED?

Your warranty does not cover:

- labor charges for installation or setup of the product, adjustment of customer controls on the product, and installation or repair of antenna systems outside of the product.
- product repair and/or part replacement because of misuse, accident, unauthorized repair or other cause not within the control of Philips Consumer Electronics.
- reception problems caused by signal conditions or cable or antenna systems outside the unit.
- a product that requires modification or adaptation to enable it to operate in any country other than the country for which it was designed, manufactured, approved and/or authorized, or repair of products damaged by these modifications.
- incidental or consequential damages resulting from the product. (Some states do not allow the exclusion of incidental or consequential damages, so the above exclusion may not apply to you. This includes, but is not limited to, prerecorded material, whether copyrighted or not copyrighted.)
- the model or production number on the product has been altered, deleted, removed or made illegible.

Where IS SERVICE AVAILABLE?

Warranty service is available in all countries where the product is officially distributed by Philips Consumer Electronics. In countries where Philips Consumer Electronics does not distribute the product, the local Philips service organization will attempt to provide service (although there may be a delay if the appropriate spare parts and technical manual(s) are not readily available).

Where CAN I GET MORE INFORMATION?

For more information, contact the Philips Customer Care Center by calling [\(877\) 835-1838 \(U.S.A. customers only\)](tel:8778351838) or [\(919\) 573-7855](tel:9195737855).

Before Requesting Service...

Please check your owner's manual before requesting service. Adjustments of the controls discussed there may save you a service call.

TO GET WARRANTY SERVICE IN U.S.A., PUERTO RICO OR U.S. VIRGIN ISLANDS...

Contact the Philips Customer Care Center phone number listed below for product assistance and procedures for servicing:

[Philips Customer Care Center](#)

[\(877\) 835-1838](tel:(877)835-1838) or [\(919\) 573-7855](tel:(919)573-7855)

(In U.S.A., Puerto Rico and U.S. Virgin Islands, all implied warranties, including implied warranties of merchantability and fitness for a particular purpose, are limited in duration to the duration of this express warranty. But, because some states do not allow limitations on how long an implied warranty may last, this limitation may not apply to you.)

TO GET WARRANTY SERVICE IN CANADA...

Please contact Philips at:

[\(800\) 479-6696](tel:(800)479-6696)

Three years free parts and three years free labor will be provided at Philips Canada depot or any one of its authorized service centers.

(In Canada, this warranty is given in lieu of all other warranties. No other warranties are expressed or implied, including any implied warranties of merchantability or fitness for a particular purpose. Philips is not liable under any circumstances for any direct, indirect, special, incidental or consequential damages, howsoever incurred, even if notified of the possibility of such damages.)

REMEMBER... Please record the model and serial numbers found on the product below.

MODEL # _____

SERIAL # _____

This warranty gives you specific legal rights. You may have other rights which vary from state/province to state/province.

Before contacting Philips, please prepare the following details so we can solve your problem quickly.

- Philips type number
- Philips serial number
- Purchase date (copy of purchase may be required)
- PC environment Processor:
 - 286/386/486/Pentium Pro/Internal memory
 - Operating system (Windows, DOS, OS/2, Apple Macintosh)

- Fax/Modem/Internet program?

- Other cards installed

Having the following information available will also help speed up the process:

- Your proof of purchase indicating: date of purchase, dealer name, model and product serial number.
- The full address to which the swap model should be delivered.

Just a phone call away

Philips customer help desks are located worldwide. Within the U.S. you can contact Philips customer care Monday-Friday from 8:00 AM-9:00 PM Eastern Time (ET) and on Saturdays from 10:00 AM-5:00 PM ET hrs by using one of the contact phone numbers.

For more information on this and more great Philips products visit our website at:

Website: <http://www.philips.com>

Glossary

[A](#) [B](#) [C](#) [D](#) [E](#) [F](#) [G](#) [H](#) [I](#) [J](#) [K](#) [L](#) [M](#) [N](#) [O](#) [P](#) [Q](#) [R](#) [S](#) [T](#) [U](#) [V](#) [W](#) [X](#) [Y](#) [Z](#)

A

Active matrix

This is a kind of liquid crystal display structure in which switching transistors are attached to each pixel to control the on/off voltage. It produces a brighter and sharper display with a broader viewing angle than a passive matrix display. Also refer to TFT (thin film transistor).

Amorphous silicon (a-Si)

A semiconductor material that is used to make the thin film transistors (TFTs) layer of an active matrix LCD.

Aspect ratio

The width-to-height ratio of the active area of a display. In general, most monitors have an aspect ratio of 4:3. Wide monitors or TVs have an aspect ratio of 16:9 or 16:10.

B

Backlight

The light source for a transmissive LCD. There are two techniques used in nowadays LCD designs. Most TFT LCD panels use CCFLs (cold cathode fluorescent light) and a diffuser panel directly behind the liquid crystal layer. New technology using Light Emitting Diodes (LED) are still under development.

Brightness

The dimension of color that is referred to an achromatic scale, ranging from black to white, also called lightness or luminous reflectance. Because of confusion with saturation, the use of this term should be discouraged.

C

CCFL(cold cathode fluorescent light)

These are the fluorescent light tubes providing the light for the LCD module. These tubes are generally very thin, approximately 2 mm in diameter.

Chromaticity

That part of color specification, which does not involve illuminance. Chromaticity is two-dimensional and specified by pairs of numbers such as dominant wavelength and purity.

CIE (Commission International de l'Eclairage)

The International Commission on Illumination, the primary international organization concerned with color and color measurement.

Color temperature

A measurement of the color of light radiated by an object while it is being heated. This measurement is express in terms of absolute scale, (degrees Kelvin). Lower Kelvin temperatures such as 2400° K are red; higher temperatures such as 9300° K are blue. Neutral temperature is white, at 6504° K. Philips monitors generally offers 9300° K, 6500° K, and user define.

Contrast

The luminance variation between light and dark areas in an image.

Contrast ratio

The ratio of luminance between the brightest white pattern and the darkest black pattern.

[RETURN TO TOP OF THE PAGE](#)

D**D-SUB**

A VGA Analog input connector. Your monitor comes with a D-Sub cable.

Digital Visual Interface (DVI) (available for selective models)

The Digital Visual Interface (DVI) specification provides a high-speed digital connection for visual data types that is display technology independent. The interface is primarily focused at providing a connection between a computer and its display device. The DVI specification meets the needs of all segments of the PC industry (workstation, desktop, laptop, etc.) and will enable these different segments to unite around one monitor interface specification.

The DVI interface enables:

1. Reduce signal loss and video noise in signal due to less signal conversion.
2. Independent from display technology, and can be used on LCD, Plasma, LCOS, etc.
3. Plug and play through hot plug detection, EDID and DDC2B.
4. Digital and Analog support in a single connector (DVI-I only).

[RETURN TO TOP OF THE PAGE](#)

E***Energy Star Computers Program***

An energy conservation program launched by the US Environmental Protection Agency (EPA), promotes the manufacture and marketing of energy-efficient office automation equipment. Companies joining this program, must be willing to commit themselves to manufacture one or more products capable of going into a low -power state (< 30 W) either after a period of inactivity, or after a predetermined time selected by the user.

[RETURN TO TOP OF THE PAGE](#)

G***Gamma***

Screen luminance as a function of video voltage approximately follows a mathematical power function of the input video signal, the exponent of which is called gamma.

Grayscale

An achromatic scale ranging from black through a series of successively lighter grays to white. Such a series may be made up of steps, which appear to be equally distant from one another. If the Analog/ Digital converter is 8 bit, then the monitor can display at most $2^8 = 256$ levels. For a color monitor, R.G.B. each color has 256 levels. Thus, total color can display is $256 \times 256 \times 256 = 16.7$ million.

H***Hue***

The main attribute of a color that distinguishes it from other colors. For example, a color may have a

green, yellow, or purple hue. Color defined as having hue are know as chromatic colors. White, black, and grays possess no hue.

I***IPS (In Plane Switching)***

A technique of improving the viewing angle of an LCD where the liquid crystal molecules are switched in the plane of the LCD layer rather than vertical to it.

L***LCD (liquid crystal display)***

A display composed of liquid crystal suspended between two transparent sheets. The display is composed thousands of pixels which can be turned on or off with electrical stimulation. Thus, colorful images/texts can be generated.

Liquid crystal

The compound found in liquid crystal displays. Liquid crystal reacts predictably when electrically stimulated. This makes it the ideal compound to turn LCD pixels "on" or "off." Liquid crystal is sometimes abbreviated as LC.

Luminance

A measure of the brightness or luminous intensity of light, usually expressed in units of Candelas per square meter (cd/m²) or foot Lamberts. 1 fL=3.426 cd/m².

[RETURN TO TOP OF THE PAGE](#)

N

Nit

A unit of luminance equal to 1 cd/m² or 0.292 ftL.

P***Pixel***

PICTure Element; the smallest element on a computerized CRT or LCD image, and hence a display.

Polarizer

A light filter which only allows light waves of a certain rotation through. Polarized material with perpendicular filtering is used in LCDs to enclose the liquid crystal. The liquid crystal is then used as the medium which twists the light waves 90° in order to allow the light to pass through or not.

R***Refresh rate***

The number of times per second the screen is refreshed or redrawn. This number is usually stated in Hz (Hertz) or cycles per second. A rate of 60 Hz is equal to 60 times per second.

S***SmartContrast***

Unique technology that dynamically analyzes displayed content and automatically optimizes a LCD monitor's contrast ratio for maximum visual clarity and viewing enjoyment, stepping up backlighting for clearer, crisper and brighter images or dimming backlighting for clear display of images on dark backgrounds. For monitors with SmartContrast, contrast ratio achieves 3000:1, the highest available today in a desktop LCD monitor.

SmartControl II

SmartControl II is monitor-based software with an easy-to-use on-screen graphic interface that guides you through fine-tuning resolution, color calibration and other display settings including brightness, contrast, clock & phase, position, RGB, white point and - on models with onboard speakers - volume adjustments.

SmartImage

SmartImage provides presets that optimize display for different types of content, dynamically adjusting brightness, contrast, color and sharpness in real time. Whether you're working with text applications, displaying images or watching a video, Philips SmartImage delivers great optimized LCD display performance.

SmartResponse

SmartResponse is exclusive Philips technology that adjusts response time to application requirements, delivering faster response times for gaming and videos or better color saturation for viewing photos and static images.

SmartManage Lite

SmartManage Lite is a system for monitoring, managing and checking status of display devices designed to meet the specific needs of growing small and medium-size businesses that minimizes costs and maximizes IT staff efficiency by remotely controlling key display settings, providing status reports, compiling usage data, overseeing energy consumption and deterring thefts.

sRGB

sRGB is a standard for ensuring correct exchange of colors between different devices (e.g. digital cameras, monitors, printers, scanners, etc.)

Using a standard unified color space, sRGB will help represent pictures taken by an sRGB compatible device correctly on your sRGB enabled Philips monitors. In that way, the colors are calibrated and you can rely on the correctness of the colors shown on your screen.

Important with the use of sRGB is that the brightness and contrast of your monitor is fixed to a predefined setting as well as the color gamut. Therefore it is important to select the sRGB setting in the monitor's OSD.

To do so, open the OSD by pressing the OK button on the front of your monitor. Move the down button to go to Color and press OK again. Use the right button to go to sRGB. Then move the down button and press OK again to exit the OSD.

After this, please do not change the brightness or contrast setting of your monitor. If you change

either of these, the monitor will exit the sRGB mode and go to a color temperature setting of 6500K.

Other:

USB plug: An upstream and a downstream USB plug is provide for user's convenience.

T

TFT(thin film transistor)

Usually made from amorphous silicon (a-Si) and used as a switch to a charge storage device located below each sub-pixel on an active matrix LCD.

TrueVision

TrueVision is industry-leading, proprietary Philips testing and algorithm technology for monitor adjustment and fine tuning, an extensive process that ensures ultimate display performance in compliance with a standard four-times more stringent than Microsoft's Vista requirements from each and every monitor that leaves the factory - not just a few review samples. Only Philips goes to these lengths to deliver this exacting level of color accuracy and display quality in every new monitor.

U

USB or Universal Serial Bus

[A smart plug for PC peripherals.](#) USB automatically determines resources (like driver software and bus bandwidth) required by peripherals. USB makes necessary resources available without user intervention.

- USB eliminates "case anxiety" -- the fear of removing the computer case to install add-on peripherals. USB also eliminates adjustment of complicated IRQ settings when installing new peripherals.
- USB does away with "port gridlock." Without USB, PCs are normally limited to one printer, two Com port devices (usually a mouse and modem), one Enhanced Parallel Port add-on (scanner or video camera, for example) and a joystick. More and more peripherals for multimedia computers arrive on the market every day. With USB, up to 127 devices can run simultaneously on a computer.
- USB permits "hot plug-in." There's no need to shut down, plug in, reboot and run set-up to

install peripherals. And no need to go through the reverse process to unplug a device.

In short, USB transforms today's "Plug-and-Pray" into true Plug-and-Play!

Hub

A Universal Serial Bus device that provides additional connections to the Universal Serial Bus.

Hubs are a key element in the plug-and-play architecture of USB. The Figure shows a typical hub. Hubs serve to simplify USB connectivity from the user's perspective providing low cost and complexity.

Hubs are wiring concentrators and enable the multiple attachment characteristics of USB. Attachment points are referred to as ports. Each hub converts a single attachment point into multiple attachment points. The architecture supports concatenation of multiple hubs.

The upstream port of a hub connects the hub towards the host. Each of the other downstream ports of a hub allows connection to another hub or function. Hubs can detect, attach and detach at each downstream port and enable the distribution of power to downstream devices. Each downstream port can be individually enabled and configured at either full or low speed. The hub isolates low speed ports from full speed signaling.

A hub consists of two portions: the Hub Controller and Hub Repeater. The repeater is a protocol-controlled switch between the upstream port and downstream ports. It also has hardware support for reset and suspend/resume signaling. The controller provides the interface registers to allow communication to/from the host. Hub specific status and control commands permit the host to configure a hub and to monitor and control its ports.

Device

A logical or physical entity that performs a function. The actual entity described depends on the context of the reference. At the lowest level, device may refer to a single hardware component, as in a memory device. At a higher level, it may refer to a collection of hardware components that perform a particular function, such as a Universal Serial Bus interface device. At an even higher level, device may refer to the function performed by an entity attached to the Universal Serial Bus; for example, a data/FAX modem device. Devices may be physical, electrical, addressable, and logical.

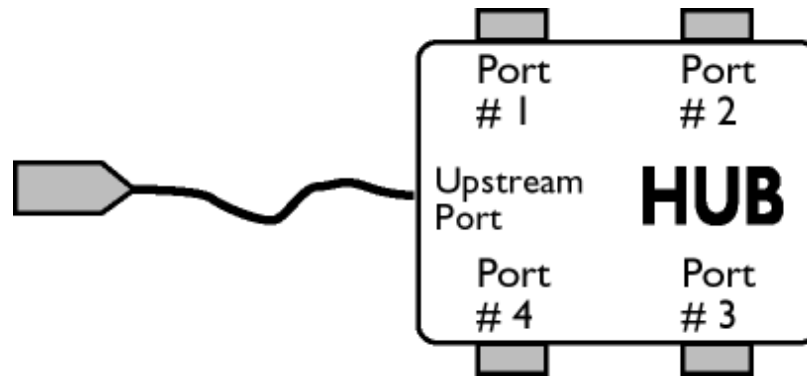

Downstream

The direction of data flow from the host or away from the host. A downstream port is the port on a hub electrically farthest from the host that generates downstream data traffic from the hub. Downstream ports receive upstream data traffic.

Upstream

The direction of data flow towards the host. An upstream port is the port on a device electrically closest to the host that generates upstream data traffic from the hub. Upstream ports receive downstream data traffic.

[RETURN TO TOP OF THE PAGE](#)

V

Vertical refresh rate

Expressed in Hz, it is the number of frames (complete pictures) written to the screen every second.

[RETURN TO TOP OF THE PAGE](#)



Installing your LCD monitor driver
Download and Printing Instructions

Download and Print

Installing Your LCD monitor driver

System requirements:

- PC running Windows 95, Windows® 98, Windows® 2000 , Windows® Me, Windows® XP, Windows® Vista or later
- Find your driver ".inf/.icm/.cat" at : /PC/drivers/

Read the "Readme.txt" file before installing.

This page provides an option to read the manual in .pdf format. PDF files can be downloaded into your hard disk, then viewed and printed with Acrobat Reader or through your browser.

If you do not have Adobe® Acrobat Reader installed, click on the link to install the application.
[Adobe® Acrobat Reader for PC](#) / [Adobe® Acrobat Reader for Apple Macintosh](#).

Download instructions:

To download the file:

1. Click-and-hold your mouse over the icon below. (Windows® 95/98/2000/Me/XP/Vista users right-click)

Download



[220CW9.pdf](#)

2. From the menu that appears, choose 'Save Link As...', 'Save Target As...' or 'Download Link to Disk'.

3. Choose where you would like to save the file; click 'Save' (if prompted to save as either 'text' or 'source', choose 'source').

Printing instructions:

To print the manual:

With the manual file open, follow your printer's instructions and print the pages you need.

[RETURN TO TOP OF THE PAGE](#)