

OWNER'S MANUAL

Color Television
27MS343S

MAGNAVOX
SMART. VERY SMART.



NEED HELP? CALL US!

MAGNAVOX REPRESENTATIVES ARE READY TO HELP YOU WITH ANY QUESTIONS ABOUT YOUR NEW PRODUCT. WE CAN GUIDE YOU THROUGH CONNECTIONS, FIRST-TIME SETUP, AND ANY OF THE FEATURES. WE WANT YOU TO START ENJOYING YOUR NEW PRODUCT RIGHT AWAY.

**CALL US BEFORE YOU CONSIDER RETURNING THE PRODUCT.
1-800-705-2000**

OR VISIT US ON THE WEB AT WWW.MAGNAVOX.COM

IMPORTANT!
**RETURN YOUR WARRANTY REGISTRATION CARD WITHIN 10 DAYS.
SEE WHY INSIDE.**

Return your Warranty Registration card today to ensure you receive all the benefits you're entitled to.

Once your MAGNAVOX purchase is registered, you're eligible to receive all the privileges of owning a MAGNAVOX product. So complete and return the Warranty Registration Card enclosed with your purchase at once. And take advantage of these important benefits.

Warranty Verification

Registering your product within 10 days confirms your right to maximum protection under the terms and conditions of your MAGNAVOX warranty.

Owner Confirmation

Your completed Warranty Registration Card serves as verification of ownership in the event of product theft or loss.

Model Registration

Returning your Warranty Registration Card right away guarantees you'll receive all the information and special offers which you qualify for as the owner of your model.

Congratulations on your purchase, and welcome to the "family!"



Dear MAGNAVOX product owner:

Thank you for your confidence in MAGNAVOX. You've selected one of the best-built, best-backed products available today. We'll do everything in our power to keep you happy with your purchase for many years to come.

As a member of the MAGNAVOX "family," you're entitled to protection by one of the most comprehensive warranties and outstanding service networks in the industry.

What's more, your purchase guarantees you'll receive all the information and special offers for which you qualify, plus easy access to accessories from our convenient home shopping network. Most importantly, you can count on our uncompromising commitment to your total satisfaction.

All of this is our way of saying welcome-and thanks for investing in a MAGNAVOX product.

P.S. Remember, to get the most from your MAGNAVOX product, you must return your Warranty Registration Card within 10 days. So please mail it to us right now!

Know these safety symbols



⚡ This "bolt of lightning" indicates uninsulated material within your unit may cause an electrical shock. For the safety of everyone in your household, please do not remove product covering.

⚠ The "exclamation point" calls attention to features for which you should read the enclosed literature closely to prevent operating and maintenance problems.

WARNING: TO PREVENT FIRE OR SHOCK HAZARD, DO NOT EXPOSE THIS EQUIPMENT TO RAIN OR MOISTURE.

CAUTION: To prevent electric shock, match wide blade of plug to wide slot, fully insert.

ATTENTION: Pour éviter les choc électriques, introduire la lame la plus large de la fiche dans la borne correspondante de la prise et pousser jusqu'au fond.

For Customer Use

Enter below the Serial No. which is located on the rear of the cabinet. Retain this information for future reference.

Model No. _____
Serial No. _____

IMPORTANT SAFETY INSTRUCTIONS

Read before operating equipment

1. Read these instructions.
2. Keep these instructions.
3. Heed all warnings.
4. Follow all instructions.
5. Do not use this apparatus near water.
6. Clean only with a dry cloth.
7. Do not block any of the ventilation openings. Install in accordance with the manufacturer's instructions.
8. Do not install near any heat sources such as radiators, heat registers, stoves, or other apparatus (including amplifiers) that produce heat.
9. Do not defeat the safety purpose of the polarized or grounding-type plug. A polarized plug has two blades with one wider than the other. A grounding type plug has two blades and a third grounding prong. The wide blade or third prong are provided for your safety. When the provided plug does not fit into your outlet, consult an electrician for replacement of the obsolete outlet.
10. Protect the power cord from being walked on or pinched, particularly at plugs, convenience receptacles, and the point where they exit from the apparatus.
11. Only use attachments/accessories specified by the manufacturer.
12. Use only with a cart, stand, tripod, bracket, or table specified by the manufacturer or sold with the apparatus. When a cart is used, use caution when moving the cart/apparatus combination to avoid injury from tip-over.
13. Unplug this apparatus during lightning storms or when unused for long periods of time.
14. Refer all servicing to qualified service personnel. Servicing is required when the apparatus has been damaged in any way, such as if the power-supply cord or plug is damaged, liquid has been spilled or objects have fallen into the apparatus, or if the apparatus has been exposed to rain or moisture, does not operate normally, or has been dropped.
15. This product may contain lead and mercury. Disposal of these materials may be regulated due to environmental considerations. For disposal or recycling information, please contact your local authorities or the Electronic Industries Alliance (www.eiae.org).
16. **Damage Requiring Service** - The appliance should be serviced by qualified service personnel when:
 - A. The power supply cord or the plug has been damaged;



- B. Objects have fallen or liquid has been spilled into the appliance;
 - C. The appliance has been exposed to rain;
 - D. The appliance does not appear to operate normally or exhibits a marked change in performance;
 - E. The appliance has been dropped or the enclosure damaged.
- 17. Tilt/Stability** - All televisions must comply with recommended international global safety standards for tilt and stability properties of its cabinet design.
- Do not compromise these design standards by applying excessive pull force to the front, or top, of the cabinet, which could ultimately overturn the product.
 - Also, do not endanger yourself, or children, by placing electronic equipment/toys on the top of the cabinet. Such items could unsuspectingly fall from the top of the set and cause product damage and/or personal injury.
- 18. Wall or Ceiling Mounting** - The appliance should be mounted to a wall or ceiling only as recommended by the manufacturer.
- 19. Power Lines** - An outdoor antenna should be located away from power lines.
- 20. Outdoor Antenna Grounding** - If an outside antenna is connected to the receiver, be sure the antenna system is grounded so as to provide some protection against voltage surges and built up static charges. Section 810 of the National Electrical Code, ANSI/NFPA No. 70-1984, provides information with respect to proper grounding of the mast and supporting structure, grounding of the lead-in wire to an antenna discharge unit, size of grounding connectors, location of antenna-discharge unit, connection to grounding electrodes, and requirements for the grounding electrode. See Figure below.
- 21. Object and Liquid Entry** - Care should be taken so that objects do not fall and liquids are not spilled into the enclosure through openings.
- 22. Battery usage CAUTION** - To prevent battery leakage that may result in bodily injury, property damage, or damage to the unit:
- Install all batteries correctly, with + and - aligned as marked on the unit.
 - Do not mix batteries (old and new or carbon and alkaline, etc.).
 - Remove batteries when the unit is not used for a long time.

Note to the Cable TV system installer: This reminder is provided to call the Cable TV system installer's attention to Article 820-40 of the NEC that provides guidelines for proper grounding and, in particular, specifies that the cable ground shall be connected to the grounding system of the building, as close to the point of cable entry as practical.

Example of Antenna Grounding as per NEC - National Electrical Code

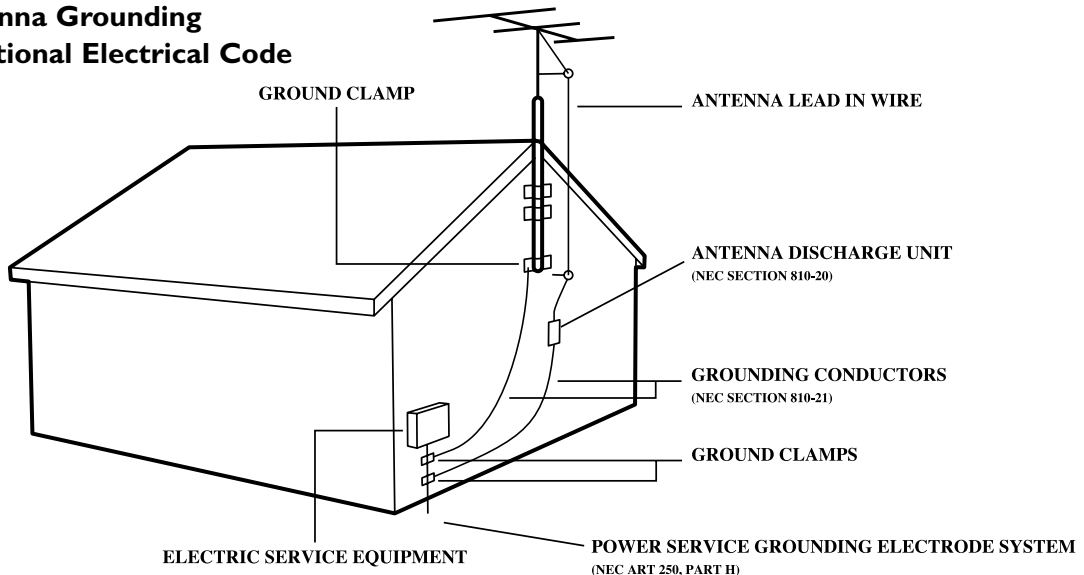

Table of Contents

Introduction

Welcome/TV Registration	2
Safety/Precautions	3
Table of Contents	4
Features	4

Getting Started

Basic Cable TV Connection	5
Basic Antenna Connection	6
Basic TV to VCR (Accessory) Connection	7
Basic TV and Remote Control Operations	8
Remote Control	9



Setup Menu

Language	10
TV/Cable TV	11
Auto Program (Setting TV Channels)	12
Manual Channel Tuning	13
Adding or Erasing Channels	14



On-screen Menus

Picture Adjustments	15
SmartPicture™	16
Clock	17
On-Timer	18
Off-Timer	19
Closed Captions	20
Sleep Timer	21



Parental Control

Understanding Parental Control	22
Parental Control Secret Code	23
Blocking Programming with Movie Ratings	24
Blocking Programming with TV Ratings	25
Parental Control Blocking Options	26
Child Lock	27

Sound

SmartSound™	28
Balance	29
Stereo and Second Audio Program	30



General Information

Helpful Hints	31
Care and Cleaning	32
Glossary	33
Index	33
Factory Service Locations	34-35
Limited Warranty	36

Here are a few of the special features of your new Color Television.

Parental Control: Allows you to block the viewing of certain TV channels if you do not want your children viewing inappropriate material.

Remote Control: Works your TV features.

Standard broadcast (VHF/UHF) or Cable TV channel capability

Stereo capability: Includes a built-in amplifier and twin-speaker system; allows reception of TV programs broadcast in stereo.

Closed Captioning: Allows you to read TV program dialog or voice conversations as on-screen text.

Automatic Channel Programming: Quick and easy selection of available stations.

Child Lock: Locks the buttons on the front of the TV so it cannot be operated accidentally by young children.

On-screen Menus: Helpful messages (in English or Spanish) for setting TV controls.

Off-Timer: Turns off the TV at a preset time.

On-Timer: Turns on the TV at a preset time to a designated TV channel or video source.

Sleep Timer: Turns off the TV within an amount of time you specify (10-120 minutes from the current time).

SmartPicture™: Lets you set the picture's color, tint, contrast, etc., for various types of programming. Settings include Sports, Movies, Weak Signal, and Personal, which sets the picture controls as you want.

SmartSound™: Lets you set the TV's sound settings for the current programming. Choices include Personal, Theatre, Music, or Voice.

Basic Cable TV Connection



The Cable TV signal into your home may be a single cable (75 ohm) or may include a Cable Box. In either case, the connection to the TV is easy.

If your Cable TV signal comes directly via a 75Ω coaxial cable, use the following steps.

- 1** Connect the Cable TV signal to the **75 OHM ANTENNA INPUT** jack on the rear of the TV. Screw it down tight.
- 2** Plug the TV's power cord into a power outlet and turn on the TV. Set TV/CABLE to CABLE as detailed on page 11. Refer to AUTO PROGRAM to set up your available TV channels. Details are on page 12.

If you have a Cable Box, use the following steps.

- 1** Connect the Cable TV signal to the **IN** jack on the Cable Box.
- 2** Connect a separate coaxial cable to the **OUT** jack on the Cable Box and to the **75 OHM ANTENNA INPUT** jack on the rear of the TV.
- 3** Plug the TV's power cord into a power outlet and turn on the TV. Set TV/CABLE to CABLE as detailed on page 11.
- 4** Set the TV to channel 3 or 4 (the same as the Channel 3/4 switch on your Cable Box if applicable). **Change channels at the Cable Box.**

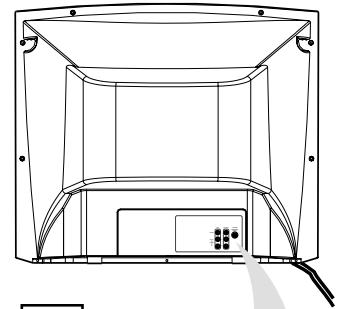

Cable TV Company

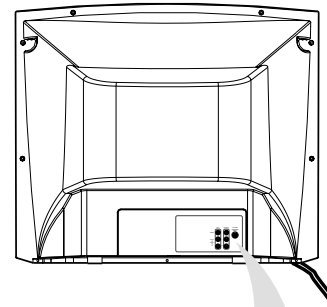
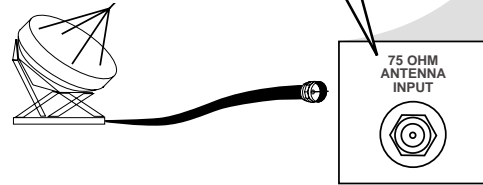

Cable TV Company

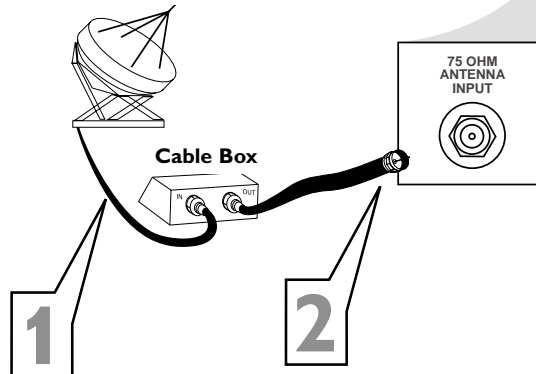

Helpful Hints

An RF coaxial cable (to connect the Cable Box to the TV) may be supplied by the Cable TV company. It is not supplied with the TV.

You can connect a Satellite Receiver the same way you would connect a Cable Box.

Your Cable Box may have separate Audio and Video Out jacks instead. If so, use audio and video cables to connect the AUDIO/VIDEO OUT jacks of the Cable Box to the AUDIO/VIDEO IN 2 jacks on the rear of the TV. Press TV/AV/EXIT on the TV's remote control to set the TV to the VIDEO 2 channel. Change TV channels at the Cable Box.



Basic Antenna Connection

A combination antenna receives normal broadcast channels (VHF 2-13 and UHF 14-69). Your connection is easy since you will connect the antenna to the 75 OHM ANTENNA INPUT jack on the rear of the TV.

1 If your antenna has a round cable (75 ohm) on the end, then you're ready to connect it to the TV. Go to step 2. If your antenna has flat twin-lead wire (300 ohm), you first need to attach the antenna wires to the screws on a 300 to 75 ohm adapter (not supplied with TV).

2 Push the round end of the adapter or antenna cable onto the 75 OHM ANTENNA INPUT jack on the rear of the TV. If the round end of the antenna cable is threaded, screw it down tight.

3 Plug the TV's power cord into a power outlet and turn on the TV. Set TV/CABLE to TV as detailed on page 11. Refer to AUTO PROGRAM to set up your available TV channels. Details are on page 12.

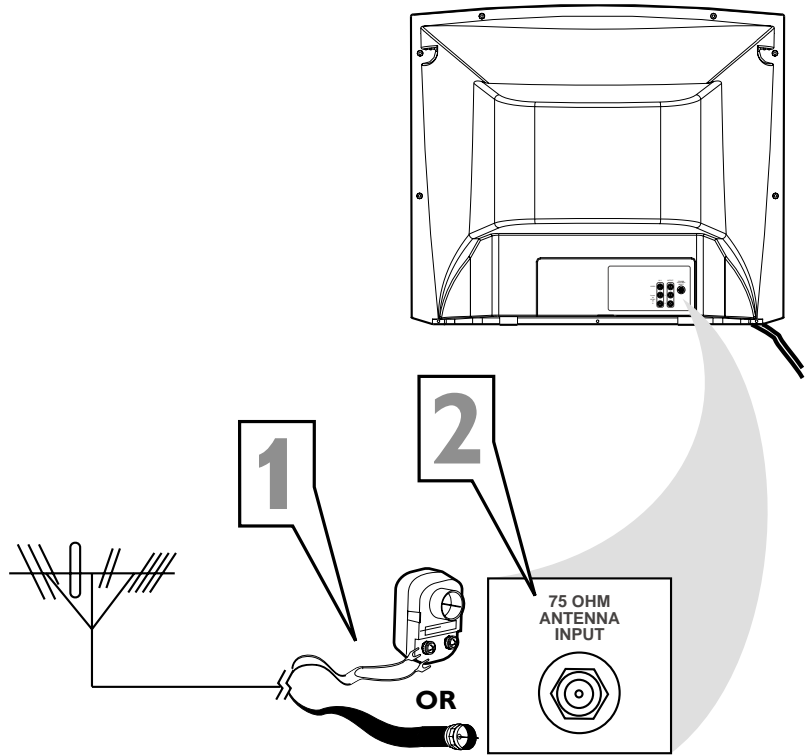

If you have separate UHF and VHF antennas, you need an optional combiner to connect the antennas to the TV.

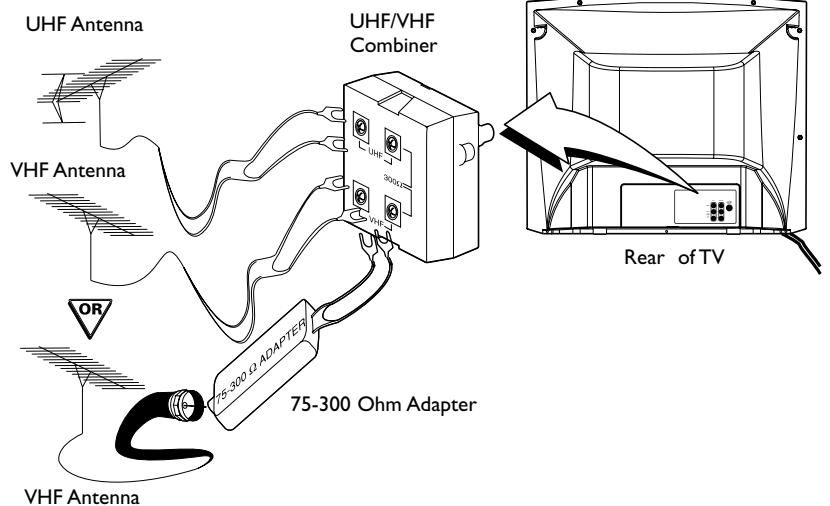

Basic TV to VCR (Accessory) Connection



The basic Antenna/Cable TV to Accessory (VCR, DVD Player, etc.) to TV connection is shown at right. For other hookups (such as those with Cable Boxes), refer to the owner's manual of the Cable Box or other Accessories.

- 1** Connect a yellow video cable to the **VIDEO IN 2** jack on the rear of the TV and to the **VIDEO OUT** jack on your **VCR** (or other accessory).
- 2** Connect red and white audio cables to the **AUDIO IN 2** jacks (left and right) on the rear of the TV and to the **AUDIO OUT** jacks on the **VCR** (or other device). Match the cable colors to the jack colors.
- 3** Turn on the TV and the **VCR**.
- 4** Press the **TV/AV/EXIT** button on the TV's remote control until **VIDEO 2** appears in the upper right corner of the TV screen. When you play material on the VCR, DVD Player, etc. that is connected to the **AUDIO** and **VIDEO IN 2** jacks on the rear of the TV, it will appear on the TV on the **VIDEO 2** channel.

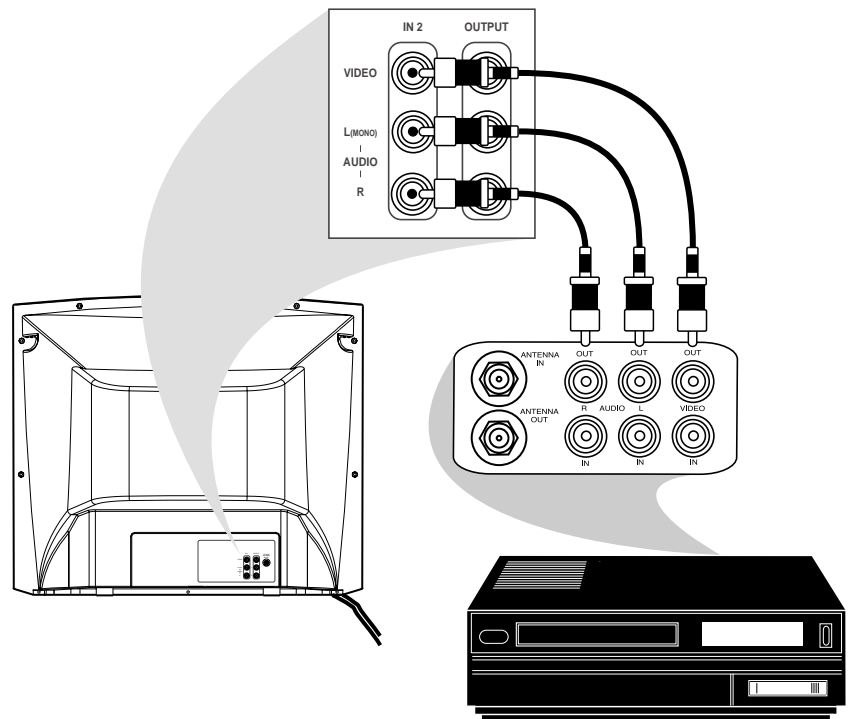

Helpful Hints

Audio and video cables are not supplied with the TV. Audio cables are usually marked with red and white. Video cables (CVBS) are usually marked with yellow.

You can connect the antenna or Cable TV signal to either the **ANTENNA IN** jack on your VCR or to the **75 OHM ANTENNA INPUT** jack on the TV. If you connect it to the VCR, choose TV channels at the VCR. Connect it to the VCR if you want to record TV programming through the VCR.

Your VCR may not have Audio and Video Out jacks, but only an **RF** or **ANTENNA OUT** jack. Use an **RF** coaxial cable to connect the VCR's **ANTENNA OUT** jack to the TV's **75 OHM ANTENNA INPUT** jack.

There are more **AUDIO** and **VIDEO IN** jacks at the lower-right corner of the rear of the TV. These are the **AUDIO** and **VIDEO IN 1** jacks. Use these if you have more equipment to connect to the TV. To view material playing on equipment connected to these jacks, select the **VIDEO 1** channel at the TV. (Press **TV/AV/EXIT** so **VIDEO 1** appears in the top right corner of the TV screen.)

There is also an **S-VIDEO IN** jack in this area. Use **S-Video** connections instead if your DVD Player, Camcorder, etc., has an **S-Video Out** jack. **S-Video** provides a clearer picture than the standard **CVBS** video (the yellow jack). Choose the **VIDEO 1** channel to view material playing on equipment connected to the **S-VIDEO IN** jack.

Use either the **S-VIDEO IN 1** jack or the **VIDEO IN 1** jack. You cannot use both at the same time for the same piece of equipment. Doing so would interfere with the picture display.

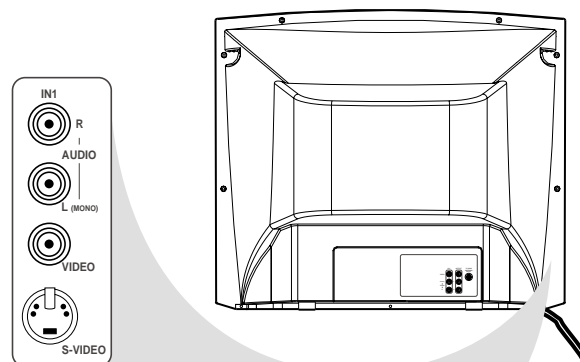



Basic TV and Remote Control Operations

Television

- 1** Press **POWER** to turn on the TV.
- 2** Press **VOL. ▲** to increase the sound level. Press **VOL. ▼** to lower the sound level.
- 3** Press **CH. ▲** or **CH. ▼** to select TV channels.
- 4** Press **MENU** to see the TV's on-screen menu. In the menu, use **VOL. ▲/▼** and **CH. ▲/▼** to make adjustments or selections. You can press MENU on either the remote control or the front of the TV to access or remove the menu.

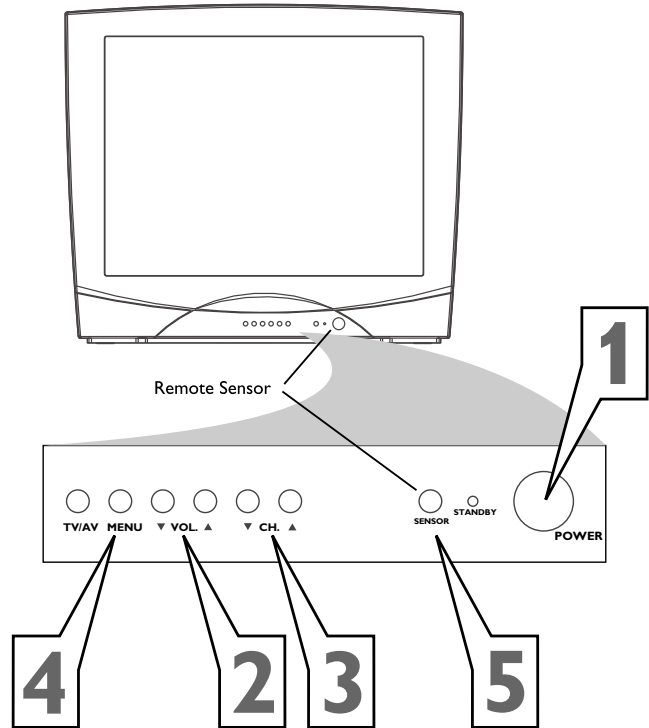

Remote Control

- 5** Point the remote control toward the remote sensor on the front of the TV when operating the TV with the remote.

Battery Installation

To load batteries into the remote control:

- 1. Remove the battery compartment lid** on the rear of the remote. Press in the tab, then lift off the lid.
- 2. Place two AAA batteries in the remote.** Be sure the (+) and (-) ends of the batteries line up correctly (as marked inside the remote).
- 3. Reattach the battery compartment lid.**

Battery Installation

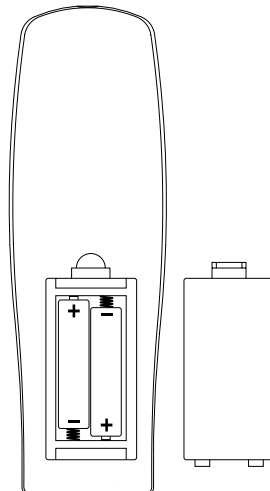

Helpful Hints



The channel number will appear briefly when you change channels. Or, press DISPLAY on the remote to see the channel number.

Press TV/AV on the front of the TV to choose TV channels or VIDEO 1 or VIDEO 2.

Remote Control



STANDBY **Button**

Press to turn the TV on or off (standby). You also can turn on the TV by pressing the CH (annel) / buttons on the front of the TV.

SLEEP **Button**

Press to select a time period (10 minutes to 120 minutes in 10-minute increments) after which the TV will turn itself off. Details are on page 21.

SMART PICTURE **Button**

Press to select one of the four picture settings (MOVIES, SPORTS, WEAK SIGNAL, or PERSONAL).

Details are on page 16.

SMART SOUND **Button**

Press to select one of the four sound effect settings: THEATRE, PERSONAL, VOICE, or MUSIC.

Details are on page 28.

MENU **Button**

Press to see the TV's on-screen menu.

Press to go to the previous menu or to remove a menu from the screen.



VOL (volume) +/- **Buttons**

Press to adjust the TV sound level.

DISPLAY **Button**

Press to see the current channel number on the TV screen. Press to remove a menu from the screen.

MUTE **Button**

Press to cancel or restore the TV sound. Pressing the volume buttons (VOL / or VOL +/-) also will cancel mute and restore the sound.

CALL **Button**

Press to switch between the two channels you bookmarked.

BOOKMARK **Button**

Press to mark two channels that you can recall with the CALL button. You cannot bookmark the Audio/Video In channels (VIDEO 1 and VIDEO 2).

TV/AV/EXIT **Button**

Press to select TV channels or the Audio/Video In channels (VIDEO 1 or VIDEO 2). Press to remove a TV menu.

MTS **Button**

Press to select a sound mode if available with the TV programming: MONO, STEREO, SAP, or MONO+SAP. Details are on page 30.

CH (channel) +/- **Buttons**

Press to select memorized TV channels.

Number **Buttons**

Press to select TV channels directly. For single-digit channels, press "0" first, then the number of the channel.

For channels 100 and above, press the 100 button first, then the next two numbers of the channel. For example, to choose channel 115, press the 100 button, then Number 1, then Number 5.

(You can select channels above 69 only if you have Cable TV. Make sure TV/CABLE is set to CABLE. Details are on page 11.)

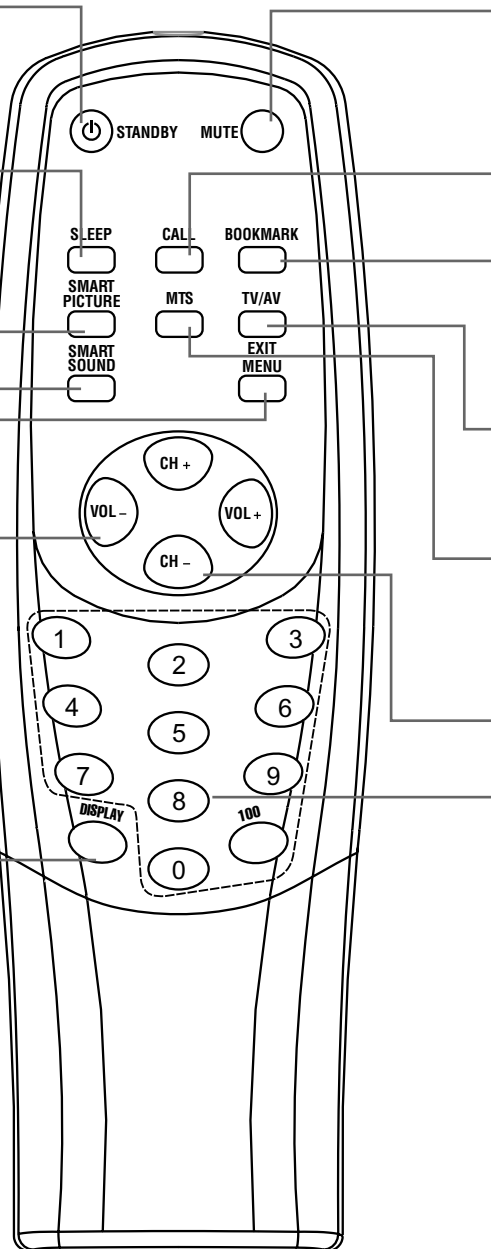



Language

You can set the TV's on-screen menu to be in English or Spanish.

- 1 Press **MENU** to see the menu.
- 2 Press **VOL +** or **VOL -** to highlight **SET**.
- 3 Press **CH+** or **CH-** to highlight **LANGUAGE**.
- 4 Press **VOL +** or **VOL -** to enter the **LANGUAGE** menu.
- 5 Press **CH+** or **CH-** to select **ENGLISH** or **ESPAÑOL** (Spanish).
- 6 Press **VOL +** or **VOL -** to confirm your selection.
- 7 Press **TV/AV/EXIT** to remove the menu from the screen.

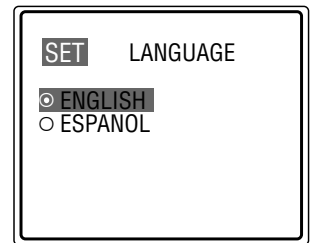
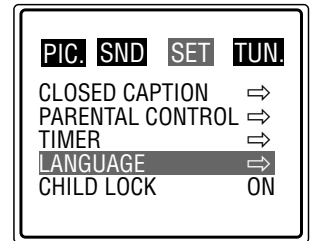
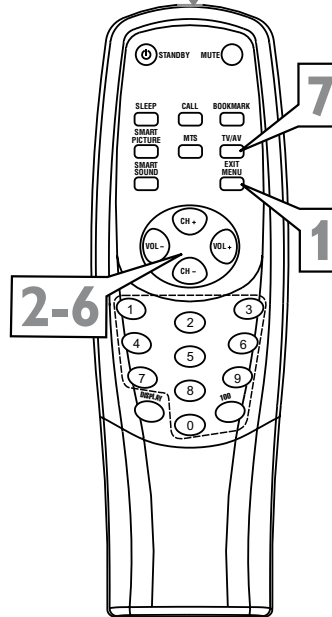
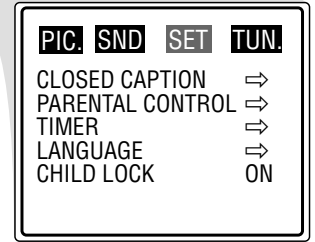
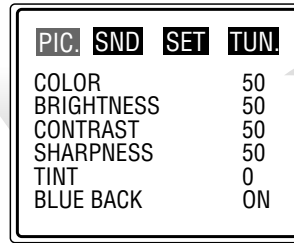

Helpful Hint

The Language control only affects the language of the TV menus. It does not change the other on-screen text features, such as Closed Captions.

TV/Cable TV



It's important for the TV to know what type of signal - Cable TV or a normal Antenna - you are using. To tell the TV whether you are using a Cable TV signal, set TV/CABLE to TV or CABLE as follows.

- 1** Press **MENU** to see the menu.
- 2** Press **VOL +** or **VOL -** to highlight **TUN.** (tuner).
- 3** Press **CH+** or **CH-** to highlight **TV/CABLE**.
- 4** Press **VOL +** or **VOL -** to select **TV** or **CABLE**.
Choose **CABLE** if you have Cable TV service. (See page five for connection details.) If you do not have Cable TV service and you connected an antenna to the TV, choose **TV**. (See page six for connection details.)
- 5** Press **TV/AV/EXIT** to remove the menu from the screen.

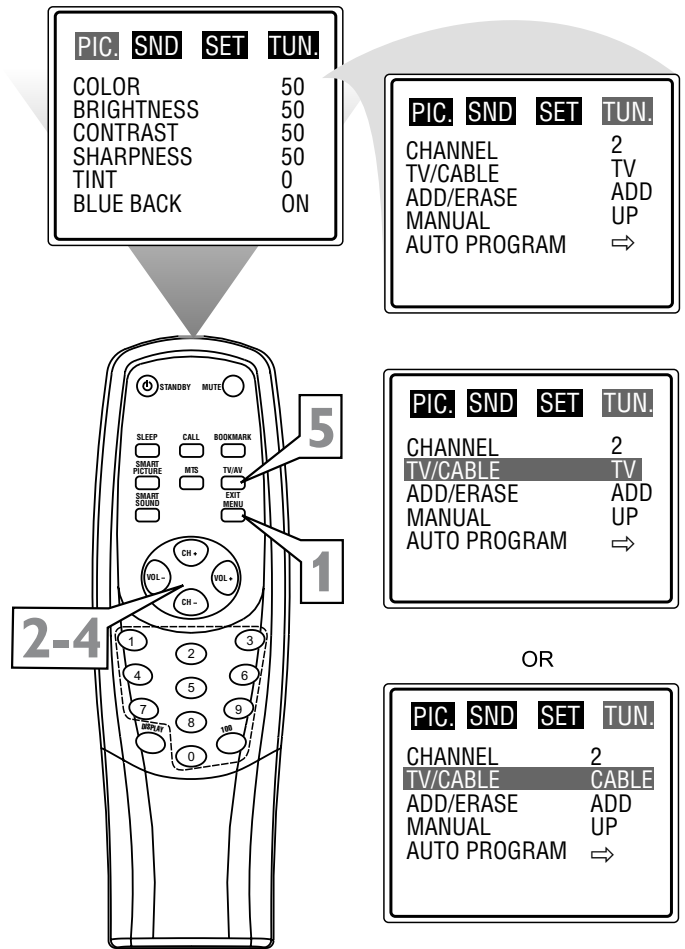

Helpful Hints

When **CABLE** is selected, channels 1-125 are available.

When **TV** is selected, only channels 2-69 are available.

You cannot select **TUN.** if the TV is on the **VIDEO 1** or **VIDEO 2** channel. Press **TV/AV/EXIT** repeatedly to get to the TV channels.



Auto Program (Setting TV Channels)

You can set your TV to receive local TV channels (from an Antenna) or Cable TV channels (when you have Cable TV service). Then, use AUTO PROGRAM to set up the channels that are available for you. This makes it easy for you to select only the available TV stations when you press CH+ or CH-. Before you start AUTO PROGRAM, connect the Antenna or Cable TV signal as detailed on pages five-six; set TV/CABLE as described on page 11.

- 1** Press **MENU** to see the menu.
- 2** Press **VOL +** or **VOL -** repeatedly to highlight **TUN.** (tuner).
- 3** Press **CH+** or **CH-** to highlight **AUTO PROGRAM**.
- 4** Press **VOL +** to start programming TV channels. Press **VOL-** if you need to stop channel programming during the process.
When channel setup is complete, **TUNING FINISHED** will appear briefly. Then the TV will go to its lowest channel.

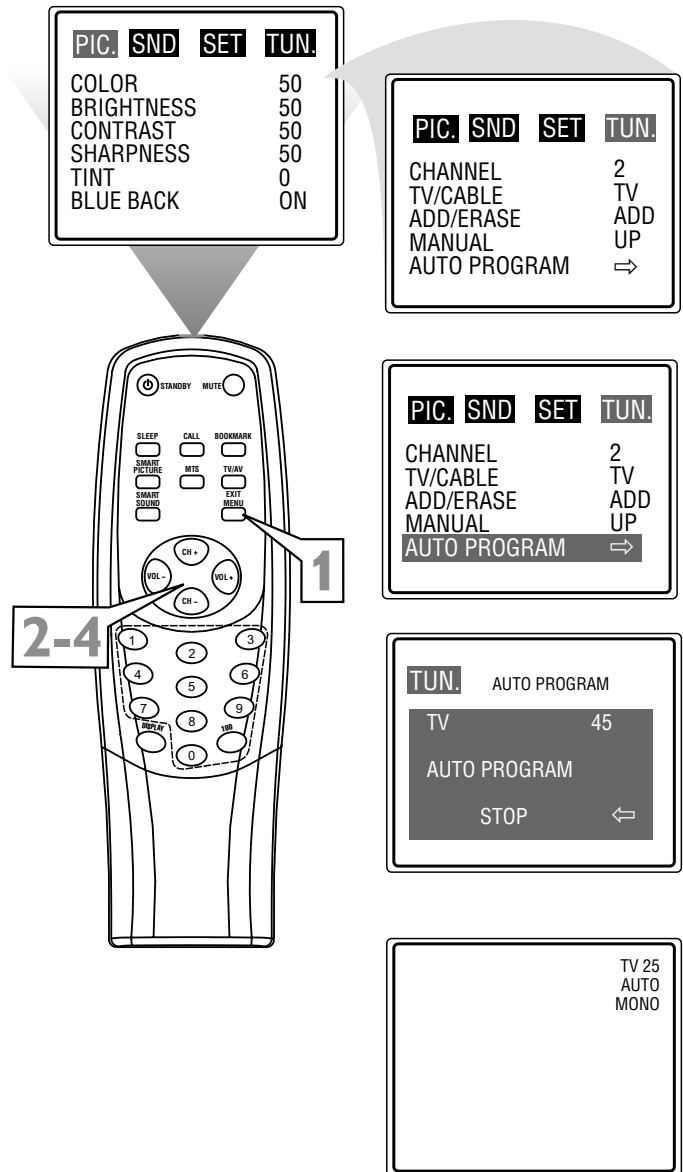

Helpful Hints

Press CH + and CH- to see which channels are in the TV's memory. You can still select non-memorized channels using the Number buttons on the remote control.

To delete unwanted channels from the TV's memory or to add more channels, see ADD/ERASE on page 14.

You cannot select TUN. if the TV is on the VIDEO 1 or VIDEO 2 channel. Press TV/AV/EXIT repeatedly to get to the TV channels.

Manual Channel Tuning



Manual Channel Tuning lets you quickly select the next available channel. For example, if you are looking for a channel between 60 and 70, start the search at channel 60 and go up.

- 1** Press **MENU** to see the menu.
- 2** Press **VOL +** or **VOL -** to highlight **TUN.** (tuner).
- 3** Press **CH+** or **CH-** to highlight **TV/CABLE**.
- 4** Press **VOL +** or **VOL -** to select **TV** or **CABLE** (whichever you have). Details are on page 11.
- 5** Press **CH+** or **CH-** to highlight **CHANNEL**.
- 6** Press **VOL+** or **VOL-** to enter the channel number at which you want to begin the search.
- 7** Press **CH+** or **CH-** to highlight **MANUAL**.
- 8** Press **VOL+** to start searching upward (for example, starting at channel 60 and going up to 61, 62, 63, etc.). Press **VOL-** when you find the channel you want. This stops the search. Otherwise, the search will stop at the first available channel.

Or, press **VOL-** to start searching downward (for example, starting at channel 60 and going down to 59, 58, 57, etc.). Then, press **VOL+** when you find the channel you want. This stops the search. Otherwise, the search will stop at the first available channel.
- 9** Press **TV/AV/EXIT** to remove the menu from the screen.

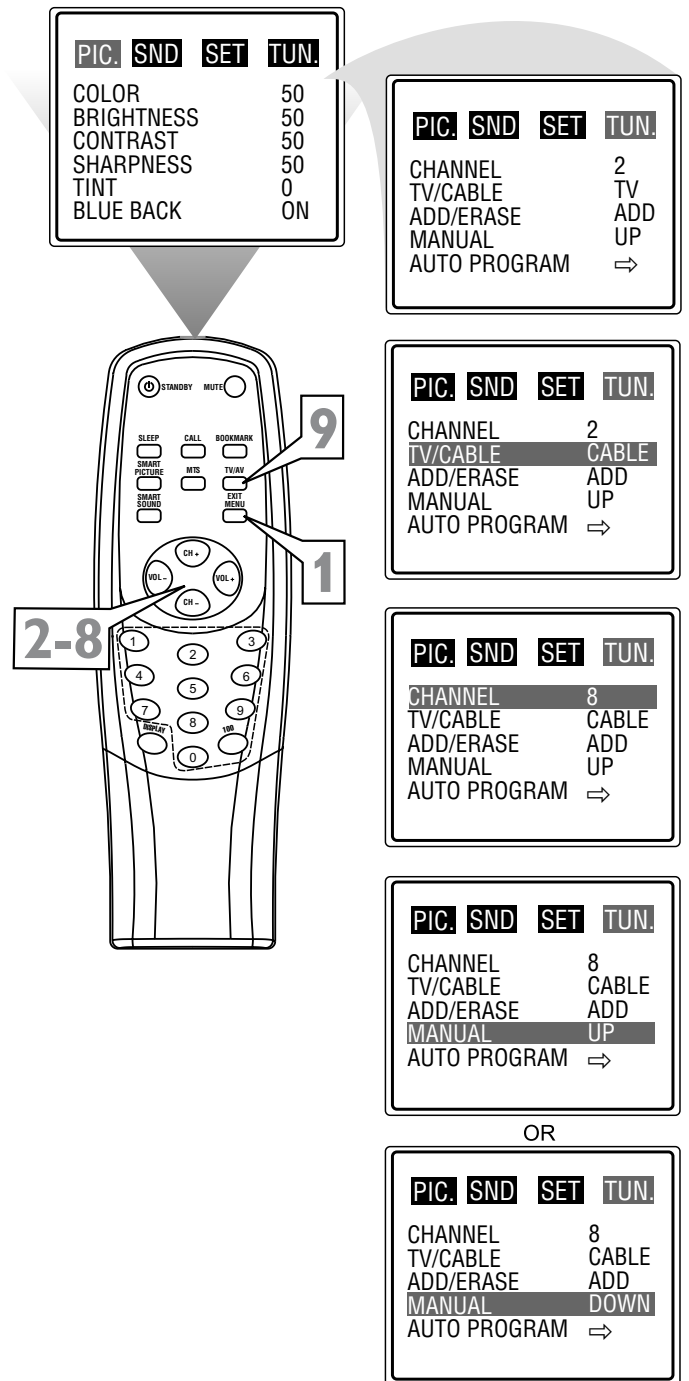

Helpful Hint

You cannot select TUN. if the TV is on the VIDEO 1 or VIDEO 2 channel. Press TV/AV/EXIT repeatedly to get to the TV channels.



Adding or Erasing Channels

You can add or erase channels from the list in the TV's memory.

- 1** Using the **Number buttons**, select the channel you wish to add or erase.
- 2** Press **MENU** to see the menu.
- 3** Press **VOL +** or **VOL -** to highlight **TUN.** (tuner).
- 4** Press **CH +** or **CH-** to highlight **ADD/ERASE**.
- 5** Press **VOL +** or **VOL -** to choose **ADD** or **ERASE**.
If you select **ADD**, the channel will be available when you press **CH+** and **CH-** to move through channels. Choosing **ERASE** will remove the channel from the TV's memory. The channel will not be available when you flip through channels with the **CH+** and **CH-** buttons.
- 6** Press **TV/AV/EXIT** to remove the menu from the screen.

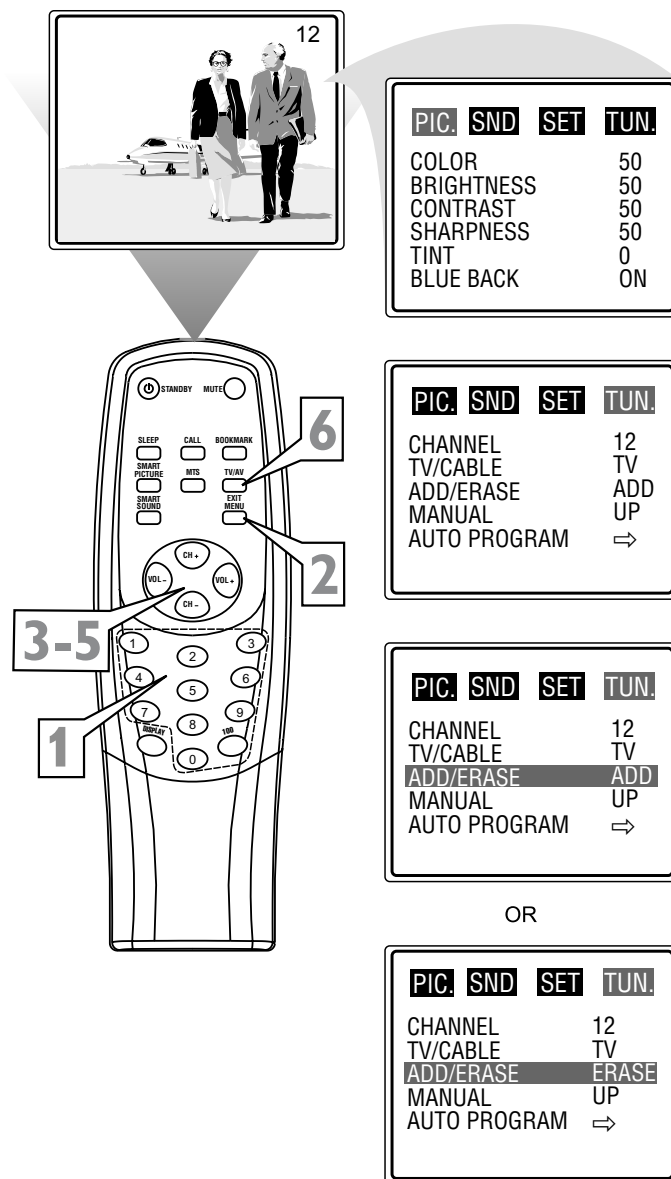

Helpful Hint

You cannot select TUN. if the TV is on the VIDEO 1 or VIDEO 2 channel. Press TV/AV/EXIT repeatedly to get to the TV channels.

Picture Adjustments



To adjust your TV picture, select a channel and follow the steps below.

- 1** Press **MENU** to see the menu.
- 2** Press **CH +** or **CH-** to highlight your choice: BRIGHTNESS, COLOR, CONTRAST, SHARPNESS, TINT, or BLUE BACK (background).
- 3** Press **VOL +** or **VOL -** to increase or decrease the element you chose. However, you can turn BLUE BACK to only ON or OFF (see below).
- 4** Press **TV/AV/EXIT** to remove the menu from the screen.

PIC.	SND	SET	TUN.
COLOR		50	
BRIGHTNESS		50	
CONTRAST		50	
SHARPNESS		50	
TINT		0	
BLUE BACK		ON	

PIC.	SND	SET	TUN.
COLOR		50	
BRIGHTNESS		50	
CONTRAST		50	
SHARPNESS		50	
TINT		0	
BLUE BACK		ON	

PIC.	SND	SET	TUN.
COLOR		50	
BRIGHTNESS		50	
CONTRAST		50	
SHARPNESS		50	
TINT		0	
BLUE BACK		ON	

PIC.	SND	SET	TUN.
COLOR		50	
BRIGHTNESS		50	
CONTRAST		50	
SHARPNESS		50	
TINT		0	
BLUE BACK		ON	

PIC.	SND	SET	TUN.
COLOR		50	
BRIGHTNESS		50	
CONTRAST		50	
SHARPNESS		50	
TINT		0	
BLUE BACK		ON	

PIC.	SND	SET	TUN.
COLOR		50	
BRIGHTNESS		50	
CONTRAST		50	
SHARPNESS		50	
TINT		0	
BLUE BACK		ON	

OR

PIC.	SND	SET	TUN.
COLOR		50	
BRIGHTNESS		50	
CONTRAST		50	
SHARPNESS		50	
TINT		0	
BLUE BACK		OFF	

Helpful Hints

BRIGHTNESS Brighten the darkest parts of the picture.

COLOR Add or reduce color.

CONTRAST Adjust the distinction between the black and white parts of the picture.

SHARPNESS Improve picture detail.

TINT Obtain natural skin tones.

BLUE BACK Turn this option ON or OFF. If you choose ON, a solid blue background screen will appear if the TV is on a weak channel (for example, if reception is very poor or if the station has gone off the air for the night). After being on such a channel for 15 minutes, the TV will turn itself off automatically.



SmartPicture

Whether you're watching a movie or a video game, your TV has automatic picture settings matched for your current program. SmartPicture resets your TV's video settings for different types of programs and viewing conditions. Each SmartPicture setting is preset at the factory to automatically adjust the TV's Brightness, Color, Contrast, Sharpness, and Tint.

- 1 Press SMART PICTURE** on the remote control. The current SmartPicture setting will appear on the screen.
- 2 Press SMART PICTURE repeatedly** to select PERSONAL, MOVIES, SPORTS, or WEAK SIGNAL. The PERSONAL setting is what you specify with the picture adjustments as described on page 15. PERSONAL is the only SmartPicture setting you can change. All others are set at the factory during production.

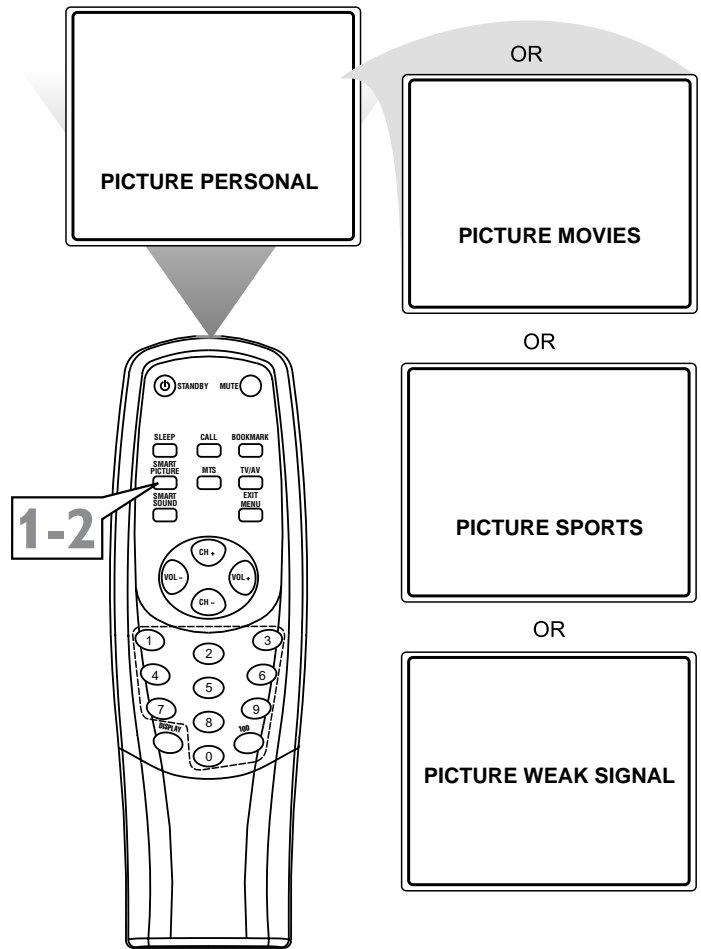

Clock



Follow these steps to set your TV's clock.

- 1** Press **MENU** to show the on-screen menu.
- 2** Press **VOL+** or **VOL-** to highlight **SET**.
- 3** Press **CH+** or **CH-** to highlight **TIMER**.
- 4** Press **VOL+** or **VOL-** to display the **TIMER** features.
- 5** Press **CH+** or **CH-** to highlight **CLOCK SET**.
- 6** Press **VOL+** or **VOL-** to enter the **CLOCK SET** menu.
- 7** Press **VOL+** or **VOL-** repeatedly to enter the current time. Press and hold **VOL+** or **VOL-** to change the time quickly in 10-minute increments.
- 8** Press **TV/AV/EXIT** to remove the menu from the screen.

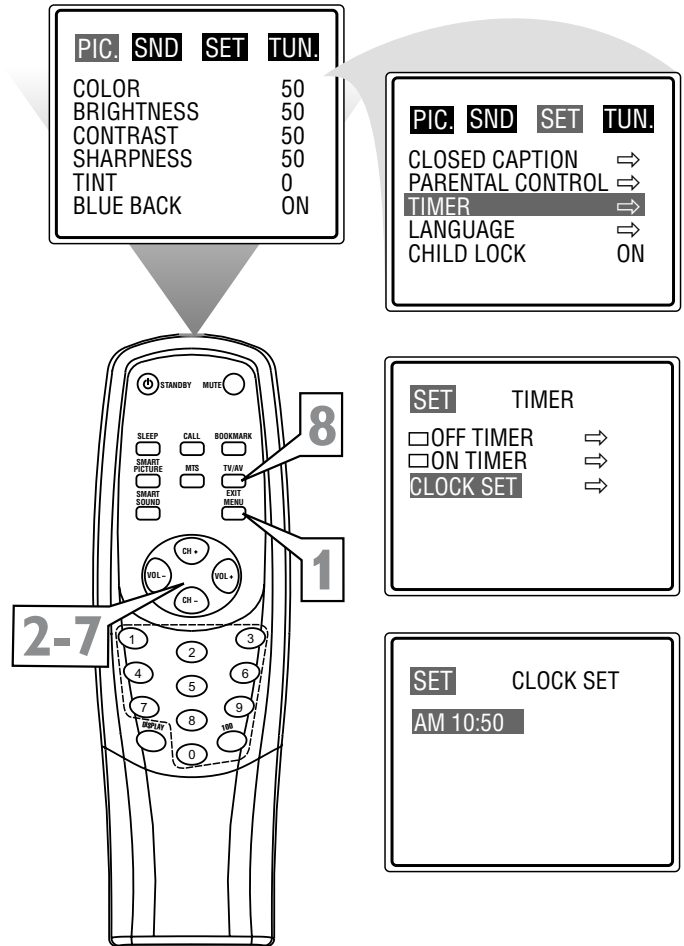

Helpful Hint

If the power fails, you must reset the clock.



On-Timer

To turn on the TV to a specific channel at a specific time, use the On-Timer. Before you begin, set the clock correctly. Details are on page 17.

- 1** Press **MENU** to show the on-screen menu.
- 2** Press **VOL+** or **VOL-** to highlight **SET**.
- 3** Press **CH+** or **CH-** to highlight **TIMER**, then press **VOL+** or **VOL-**.
- 4** Press **CH+** or **CH-** to highlight **ON TIMER**, then press **VOL+** or **VOL-**.
- 5** While the time is highlighted (top line with **AM** or **PM**), press **VOL+** or **VOL-** to enter the **ON** time. Hold down **VOL+** or **VOL-** to change the time quickly in 10-minute increments. This will be the time at which the TV will turn itself on.
- 6** Press **CH+** or **CH-** to highlight **CHANNEL**.
- 7** Press **VOL+** or **VOL-** to enter the channel number. This will be the channel to which the TV turns on at the specified time.
- 8** Press **CH+** or **CH-** to highlight **TV/CABLE**.
- 9** Press **VOL+** or **VOL-** to select **TV** or **CABLE**, depending on whether you have Cable TV service or not. Details are on page 11.
- 10** Press **CH+** or **CH-** to highlight **OFF**, **ONCE**, or **DAILY**. If you select **ONCE**, the timer will turn on the TV one time within the next 24 hours only. If you select **DAILY**, the timer will turn on the TV at the same time and to the same channel every day. Choose **OFF** to cancel the On-Timer.
- 11** Press **VOL+** or **VOL-** to confirm your choice.
- 12** Press **TV/AV/EXIT** to remove the menu.

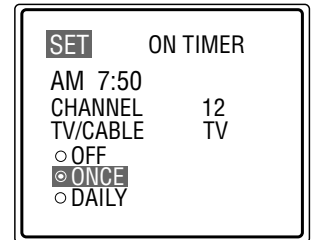
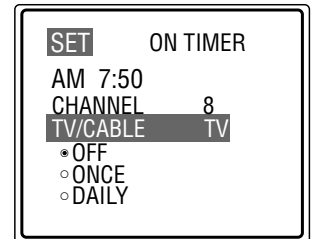
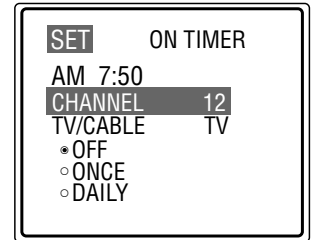
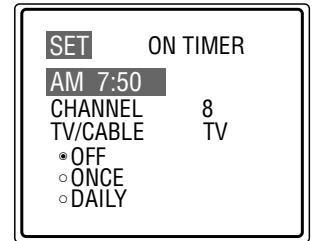
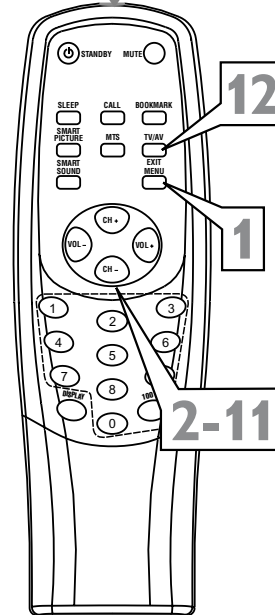
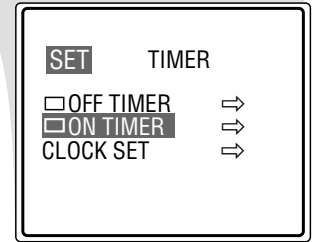
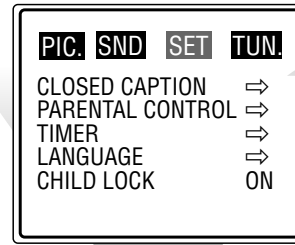

Off-Timer



To turn off the TV at a specific time every day, use the Off-Timer. Before you begin, set the clock correctly. Details are on page 17.

- 1** Press **MENU** to show the on-screen menu.
- 2** Press **VOL+** or **VOL-** to highlight **SET**.
- 3** Press **CH+** or **CH-** to highlight **TIMER**, then press **VOL+** or **VOL-**.
- 4** Press **CH+** or **CH-** to highlight **OFF TIMER**, then press **VOL+** or **VOL-**.
- 5** While the time is highlighted (top line with **AM** or **PM**), press **VOL+** or **VOL-** to enter the **OFF** time. Hold down **VOL+** or **VOL-** to change the time quickly in 10-minute increments. This will be the time at which the TV will turn itself off.
- 6** Press **CH+** or **CH-** to highlight **OFF**, **ONCE**, or **DAILY**. If you select **ONCE**, the timer will turn off the TV one time within the next 24 hours only. If you select **DAILY**, the timer will turn off the TV at the same time every day. Choose **OFF** to cancel the Off-Timer.
- 7** Press **VOL+** or **VOL-** to confirm your choice.
- 8** Press **TV/AV/EXIT** to remove the menu.

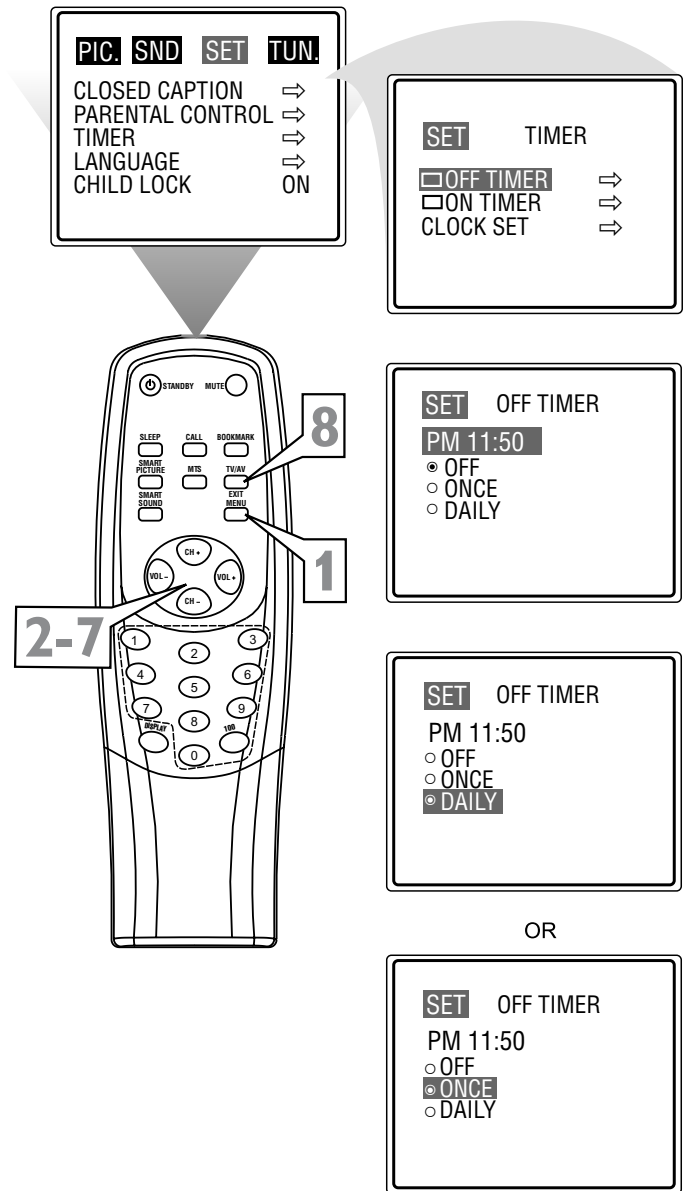



Closed Captions

Closed Captioning (CC) lets you read the voice content of TV programs on the TV screen. Designed to help the hearing impaired, on-screen text boxes will show dialog, conversations, and activity during TV programming.

- 1 Press **MENU** to show the on-screen menu.
- 2 Press **VOL+** or **VOL-** until **SET** is highlighted.
- 3 Press **CH+** or **CH-** repeatedly to highlight **CLOSED CAPTION**.
- 4 Press **VOL+** or **VOL-** to display the **CLOSED CAPTION** menu.
- 5 Press **CH+** or **CH-** to select the closed caption you want (**OFF**, **CC-1**, **CC-2**, or **CC-MUTE**). CC-MUTE sets the TV to show closed captions when you press MUTE. The TV volume will be disabled until you press MUTE again to restore the sound.
- 6 Press **VOL+** or **VOL-** to confirm your selection.
- 7 Press **TV/AV/EXIT** to remove the menu.

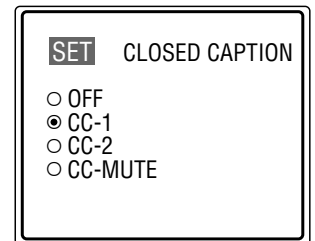
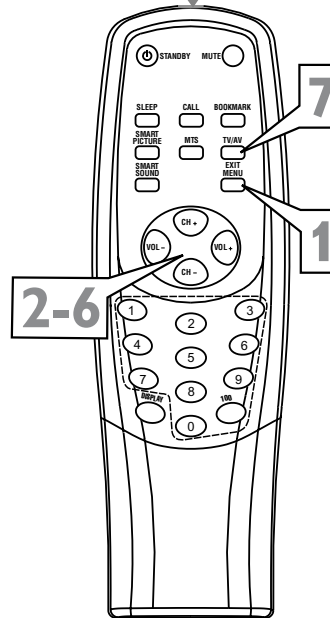
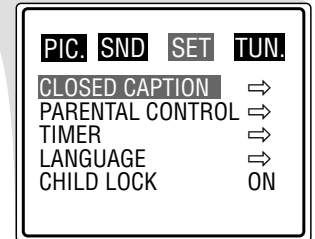
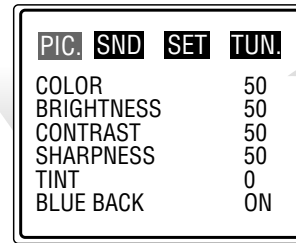

Helpful Hints

Not all TV programs and commercials are broadcast with Closed Caption information. Neither are all Closed Caption modes transmitted by a station for a closed caption program. See your TV listings for the stations and times of Closed Caption shows.

Sleep Timer



Have you ever fallen asleep in front of the TV, only to have it wake you up at two in the morning with a test pattern screeching in your ears? Well, your TV can save you that trouble by turning itself off.

- 1 Press SLEEP.** The SLEEP display will appear on the screen.
- 2 Within five seconds, press SLEEP** to pick the amount of time (in 10-minute increments up to 120 minutes) before the TV will turn itself off.

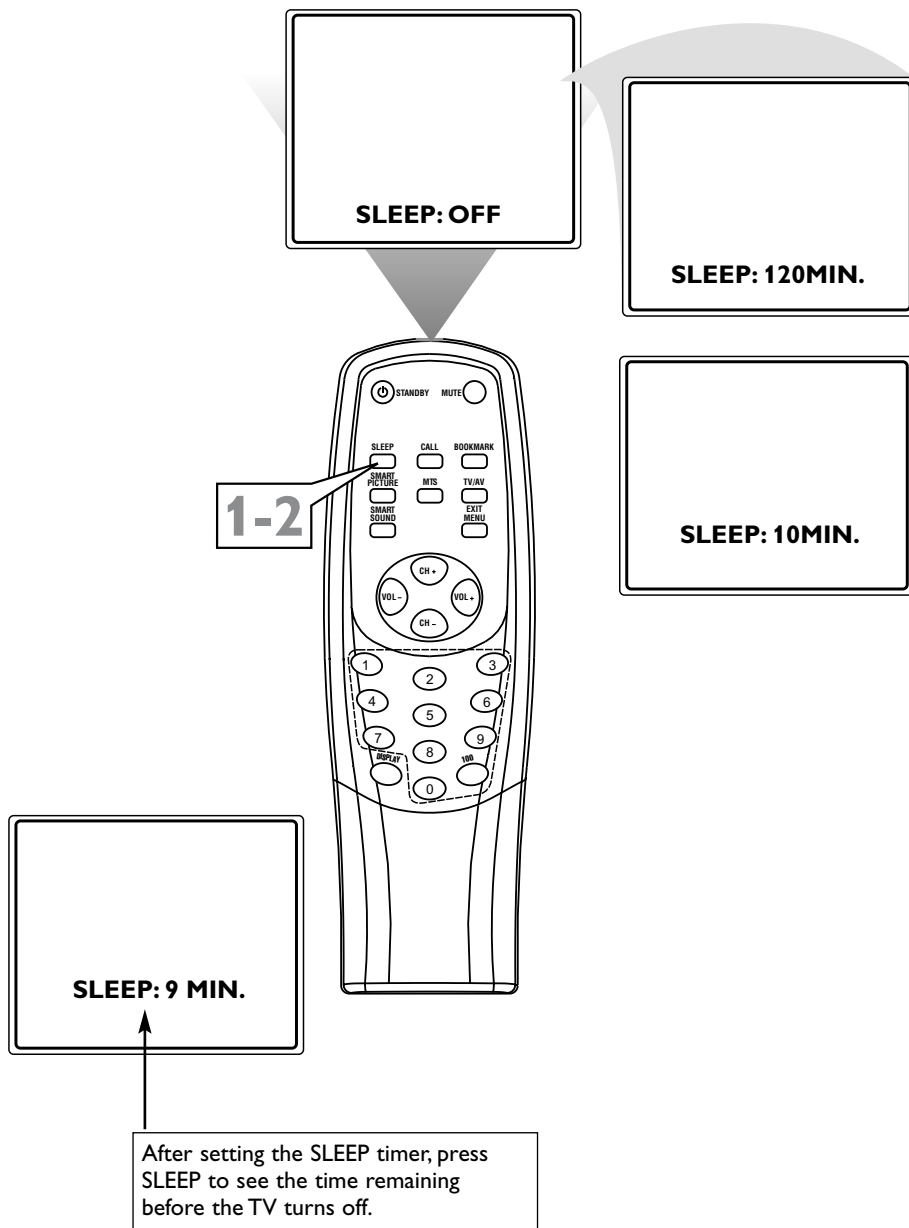



Understanding Parental Control

SmartLock processes program content advisories from broadcasters. SmartLock can respond to the content advisories and block objectionable content (offensive language, violence, sexual situations, etc.). This is a great feature to censor the type of programming children watch.

SmartLock offers various blocking options from which to choose:

MASTER ENABLE: This is the "master switch" for SmartLock. When ON, all blocking/censoring you have set is enabled. When OFF, all blocking is disabled.

BLOCK UNRATED: All unrated programs (based on Movie Ratings or TV Ratings) will be blocked if this feature is ON and MASTER ENABLE is ON.

BLOCK NO RATING: All programming with no content advisory data will be blocked if this feature is ON and MASTER ENABLE is ON.

After you set a secret code, you can block up to six ratings in TV Ratings or Movie Ratings. These ratings are set by the Motion Pictures Association of America and TV broadcasters.

MPAA Ratings (Motion Pictures Association of America)

G: General Audience - All ages admitted. Most parents would find this program suitable for all ages. This type of programming contains little or no violence, no strong language, and little or no sexual dialog or situations.

PG: Parental Guidance Suggested - This programming contains material that parents may find unsuitable for younger children. It may contain one or more of the following: moderate violence, some sexual situations, infrequent coarse language, or some suggestive dialog.

PG-13: Parents Strongly Cautioned - This programming contains material that parents may find unsuitable for children under the age of 13. It contains one or more of the following: violence, sexual situations, coarse language, or suggestive dialog.

R: Restricted - This programming is specifically designed for adults. Anyone under the age of 17 should only view this programming with an accompanying parent or adult guardian. It contains one or more of the following: intense violence, intense sexual situations, strong coarse language, or intensely suggestive dialog.

NC 17: No children under the age of 17 will be admitted. - This type of programming should be viewed by adults only. It contains graphic violence, explicit sex, or crude, indecent language.

X: Adults Only - This type of programming contains one or more of the following: very graphic violence, very graphic and explicit or indecent sexual acts, very coarse and intensely suggestive language.

TV Ratings (TV Broadcasters)

TV Y (All children) - Appropriate for all children.) Designed for a very young audience, including children ages 2-6. This type of programming is not expected to frighten younger children.

TV Y7 (Directed to Older Children) - Designed for children age 7 and above.) It may be more appropriate for children who can distinguish between make-believe and reality. This programming may include mild fantasy and comic violence (FV or fantasy violence).

TV G (General Audience) - Most parents would find this programming suitable for all ages.) This type of programming contains little or no violence, no strong language, and little or no sexual dialog or situations.

TV PG (Parental Guidance Suggested) - Contains material that parents may find unsuitable for younger children.) This type of programming contains one or more of the following: Moderate violence (V), some sexual situations (S), infrequent coarse language (L), or some suggestive dialog (D).

TV 14 (Parents Strongly Cautioned) - Contains some material that many parents would find unsuitable for children under 14 years of age.) This type of programming contains one or more of the following: intense violence (V), intense sexual situations (S), strong coarse language (L), or intensely suggestive dialog (D).

TV MA (Mature Audience Only) - Specifically designed to be viewed by adults and may be unsuitable for children under 17.) This type of programming contains one or more of the following: graphic violence (V), explicit sexual situations (S), or crude, indecent language (L).

Parental Control Secret Code



Over the next few pages you'll learn how to block programs and understand the rating terms for certain broadcasts. First, set a secret code.

- 1** Press **MENU** to show the on-screen menu.
- 2** Press **VOL+** or **VOL-** to highlight **SET**.
- 3** Press **CH+** or **CH-** to highlight **PARENTAL CONTROL**.
- 4** Press **VOL+** or **VOL-** to display the **SECRET CODE** screen.
- 5** Press **VOL+** (on the remote) and the **CH+** button on the front of the TV at the same time.
- 6** Press the **Number** buttons to enter a four-digit code. The code will appear on the screen as you enter it. The code "0000" is the default of the TV. If you have not set up a code previously, then "0000" is the code. You cannot use "0000" after you set your own code (unless you reset the code to "0000").
- 7** Press **MENU** to save the code.
- 8** The Parental Control menu will appear next. Press **TV/AV/EXIT** to remove the menu, or continue from this point to change your Parental Control settings.

PIC.	SND	SET	TUN.
COLOR			50
BRIGHTNESS			50
CONTRAST			50
SHARPNESS			50
TINT			0
BLUE BACK			ON

PIC.	SND	SET	TUN.
CLOSED CAPTION			⇄
PARENTAL CONTROL			⇄
TIMER			⇄
LANGUAGE			⇄
CHILD LOCK			ON

5 - Also press **CH+** on the front of the TV.

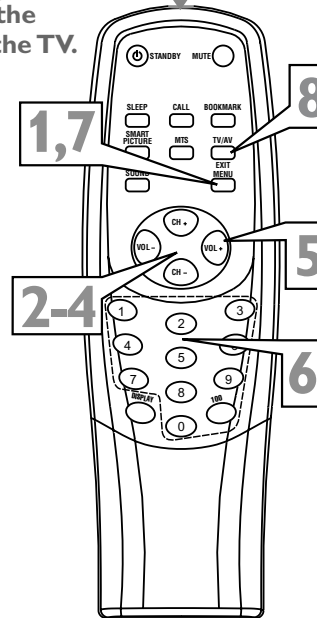

PIC.	SND	SET	TUN.
CLOSED CAPTION			⇄
PARENTAL CONTROL			⇄
TIMER			⇄
LANGUAGE			⇄
CHILD LOCK			ON

SET	PARENTAL CONTROL
	ENTER SECRET CODE: [] [] [] []

Helpful Hint

You cannot change Parental Control settings without knowing the secret code. If your code changes, someone else has altered it and possibly viewed blocked channels.



Blocking Programming with Movie Ratings

There are two types of ratings for Parental Control. One is based on movie industry ratings. The other is based on TV industry ratings. Both can be used to censor programming. Let's first look at the MPAA Rating options of Parental Control.

- 1 Press **MENU** to show the on-screen menu.
- 2 Press **VOL+** or **VOL-** to highlight **SET**.
- 3 Press **CH+** or **CH-** to highlight **PARENTAL CONTROL**.
- 4 Press **VOL+** or **VOL-** to display the **SECRET CODE** screen.
- 5 Press the **Number buttons** to enter your four-digit secret code.
- 6 Press **CH+** or **CH-** to highlight **MPAA RATING**.
- 7 Press **VOL+** or **VOL-** to display the **MPAA ratings (G, PG, PG-13, R, NC-17, and X)**.
- 8 Press **CH+** or **CH-** to select the rating you want to block.
- 9 Press **VOL+** or **VOL-** to block (or unblock) the rating. A checkmark will appear to the left of the rating when blocked. When you block a rating, higher ratings are blocked automatically. To unblock all the ratings, select **CLEAR**.
- 10 Press **TV/AV/EXIT** to remove the menu.

PIC.	SND	SET	TUN.
COLOR			50
BRIGHTNESS			50
CONTRAST			50
SHARPNESS			50
TINT			0
BLUE BACK			ON

PIC.	SND	SET	TUN.
CLOSED CAPTION			⇨
PARENTAL CONTROL			⇨
TIMER			⇨
LANGUAGE			⇨
CHILD LOCK			ON

PIC.	SND	SET	TUN.
CLOSED CAPTION			⇨
PARENTAL CONTROL			⇨
TIMER			⇨
LANGUAGE			⇨
CHILD LOCK			ON

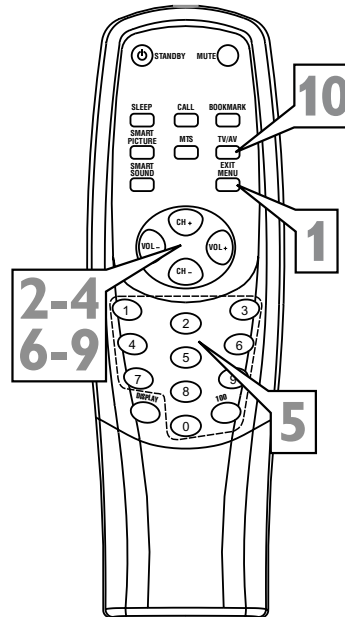

SET	PARENTAL CONTROL
	ENTER SECRET CODE:
	■■■■

SET	PARENTAL CONTROL
<input type="checkbox"/>	MPAA RATING
<input type="checkbox"/>	TV PARENTAL GUIDELINES
	BLOCK UNRATED OFF
	BLOCK NO RATING OFF
	MASTER ENABLE OFF

SET	MPAA
<input type="checkbox"/>	CLEAR
<input type="checkbox"/>	G
<input type="checkbox"/>	PG
<input type="checkbox"/>	PG-13
<input checked="" type="checkbox"/>	R
<input checked="" type="checkbox"/>	NC-17
<input checked="" type="checkbox"/>	X

Helpful Hint

Blocking any rating (ON) will block all the higher ratings automatically. For example, if R is blocked manually, NC 17 and X will be blocked automatically. To turn a rating OFF, set each rating individually.

Blocking Programming with TV Ratings



Some program ratings are based on TV industry ratings as described below.

- 1 Press **MENU** to see the menu.
- 2 Press **VOL+** or **VOL-** repeatedly to highlight **SET**.
- 3 Press **CH+** or **CH-** to highlight **PARENTAL CONTROL**.
- 4 Press **VOL+** or **VOL-** to see the **SECRET CODE** screen.
- 5 Press the **Number** buttons to enter your four-digit secret code.
- 6 Press **CH+** or **CH-** to highlight **TV PARENTAL GUIDELINES**.
- 7 Press **VOL+** or **VOL-** to display the **Parental Guidelines** (TV-Y, TV-Y7, TV-G, TV-PG, TV-14, or TV-MA).
- 8 Press **CH+** or **CH-** to select a rating.
- 9 Press **VOL+** or **VOL-** to turn the rating on or off. A checkmark appears when the rating is blocked. TV-Y and TV-G can be turned on (to block viewing) or off (to allow viewing) only. TV-Y7, TV-PG, TV-14, and TV-MA can be customized to block V (violence), F (fantasy), S (sexual situations), L (coarse language), or D (suggestive dialog). To do so, continue with these steps.
- 10 Press **CH+** or **CH-** to highlight **CONTENT**.
- 11 Press **VOL+** or **VOL-** to enter the **CONTENT** menu.
- 12 Press **CH+** or **CH-** to select a rating, then press **VOL+**.
- 13 Press **CH+** or **CH-** to select the sub-rating (FANTASY-V, VIOLENCE, SEXUAL, LANGUAGE, or DIALOG), then press **VOL+** or **VOL-** to **BLOCK** or **VIEW** that sub-rating.
- 14 Press **MENU** to return to the **PARENTAL GUIDELINES** screen and check your settings. A checkmark appears when the sub-rating is blocked.
- 15 Press **TV/AV/EXIT** to remove the menu.

SET PARENTAL CONTROL

MPAA RATING

TV PARENTAL GUIDELINES

BLOCK UNRATED OFF

BLOCK NO RATING OFF

MASTER ENABLE OFF

SET PARENTAL GUIDELINES

CLEAR F V S L D

TV-Y

TV-Y7

TV-G

TV-PG

TV-14

TV-MA

CONTENT →

SET PARENTAL GUIDELINES

CLEAR F V S L D

TV-Y

TV-Y7

TV-G

TV-PG

TV-14

TV-MA

CONTENT →

SET PARENTAL GUIDELINES

CLEAR F V S L D

TV-Y

TV-Y7

TV-G

TV-PG

TV-14

TV-MA

CONTENT →

SET PARENTAL GUIDELINES

CONTENT

TV-Y

TV-Y7 FANTASY-V -----

TV-G VIOLENCE VIEW

TV-PG SEXUAL BLOCK

TV-14 LANGUAGE BLOCK

TV-MA DIALOG BLOCK

Helpful Hints

Blocking any rating will block higher ratings automatically.

To unblock all the ratings, select **CLEAR**.



Parental Control Blocking Options

After setting your Secret Code, Parental Control offers special blocking options.

- 1 Press **MENU** to see the menu.
- 2 Press **VOL+** or **VOL-** to highlight **SET**.
- 3 Press **CH+** or **CH-** to select **PARENTAL CONTROL**.
- 4 Press **VOL+** or **VOL-** to see the **SECRET CODE** screen.
- 5 Press the **Number** buttons to enter your four-digit secret code.
- 6 Press **CH+** or **CH-** to select **MASTER ENABLE**, **BLOCK UNRATED**, or **BLOCK NO RATING**.

MASTER ENABLE: This is the "master switch" for Parental Control. When ON, all blocking/censoring is enabled. When OFF, all blocking/censoring is disabled.

BLOCK UNRATED: All unrated programs (based on Movie Ratings or TV Ratings) will be blocked if this feature is ON and MASTER ENABLE is ON.

BLOCK NO RATING: All programming with NO content advisory can be blocked if this feature is ON and MASTER ENABLE is ON.
- 7 Press **VOL+** or **VOL-** to turn the blocking option **ON** or **OFF**.
- 8 Press **TV/AV/EXIT** to remove the menu from the screen.

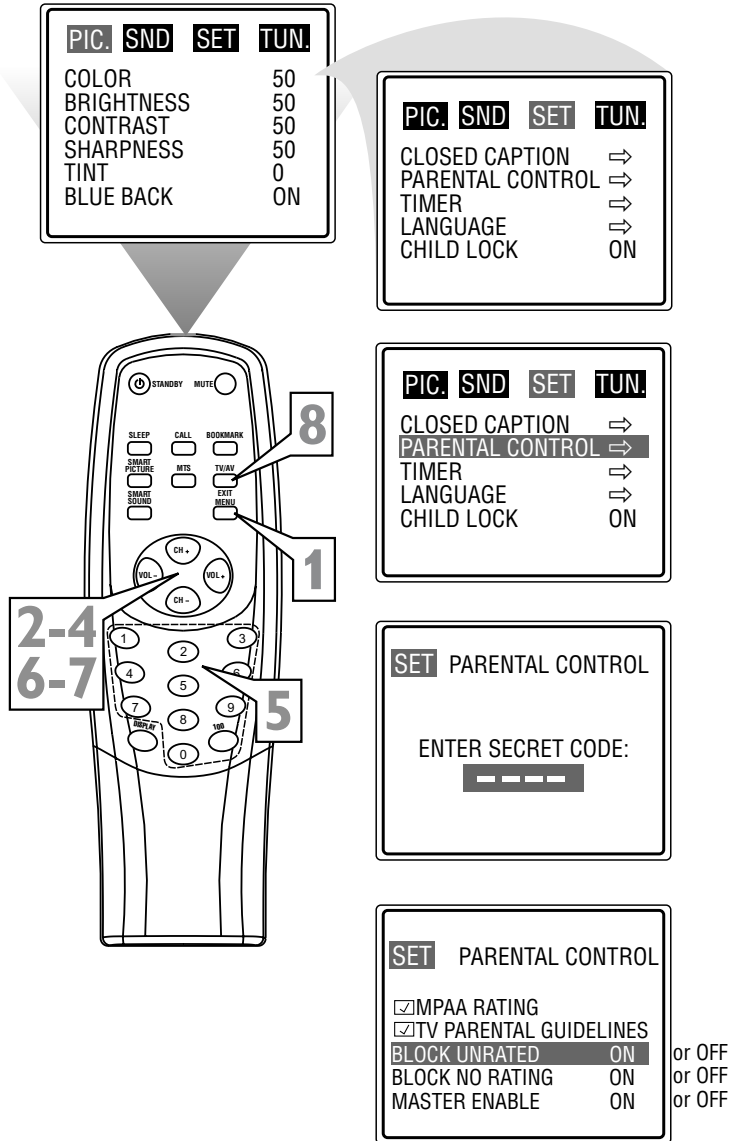

Child Lock



Child Lock allows you to lock the buttons on the front of the TV.

- 1** Press **MENU** to show the on-screen menu.
- 2** Press **VOL+** or **VOL-** repeatedly until **SET** is highlighted.
- 3** Press **CH+** or **CH-** to highlight **CHILD LOCK**.
- 4** Press **VOL+** or **VOL-** to choose **ON** or **OFF**.
Choose **ON** to disable all the buttons on the front of the TV. **CHILD LOCK ON** will appear briefly on the TV screen each time you press a button on the front of the TV.
You can still operate the TV with the remote control. You can still use the **POWER** button on the front of the TV, but only to turn off the TV (not on).
Set **CHILD LOCK** to **OFF** to cancel this feature so you can use the buttons on the front of the TV again.
- 5** Press **TV/AV/EXIT** to remove the menu from the screen.

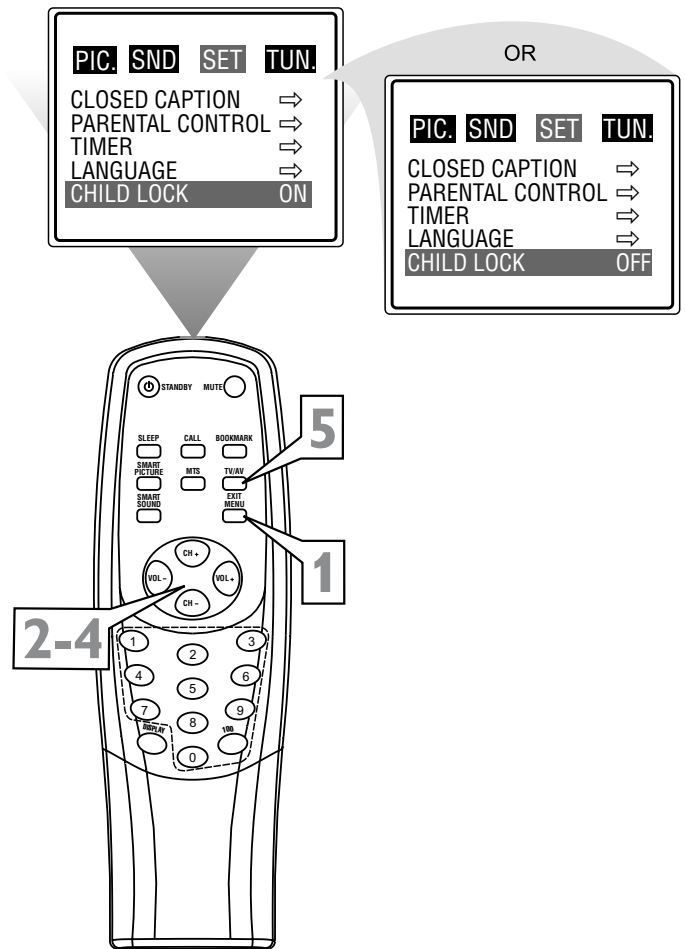



SmartSound

When you are watching a movie or video game, your TV has sound settings that match these programming types.

- 1** Press **MENU** to show the on-screen menu.
- 2** Press **VOL+** or **VOL-** to highlight **SND (Sound)**.
- 3** Press **CH+** or **CH-** to highlight **SMART SOUND**.
- 4** Press **VOL+** or **VOL-** to select **PERSONAL, VOICE, MUSIC, or THEATRE**.
- 5** Press **TV/AV/EXIT** to remove the menu from the screen.

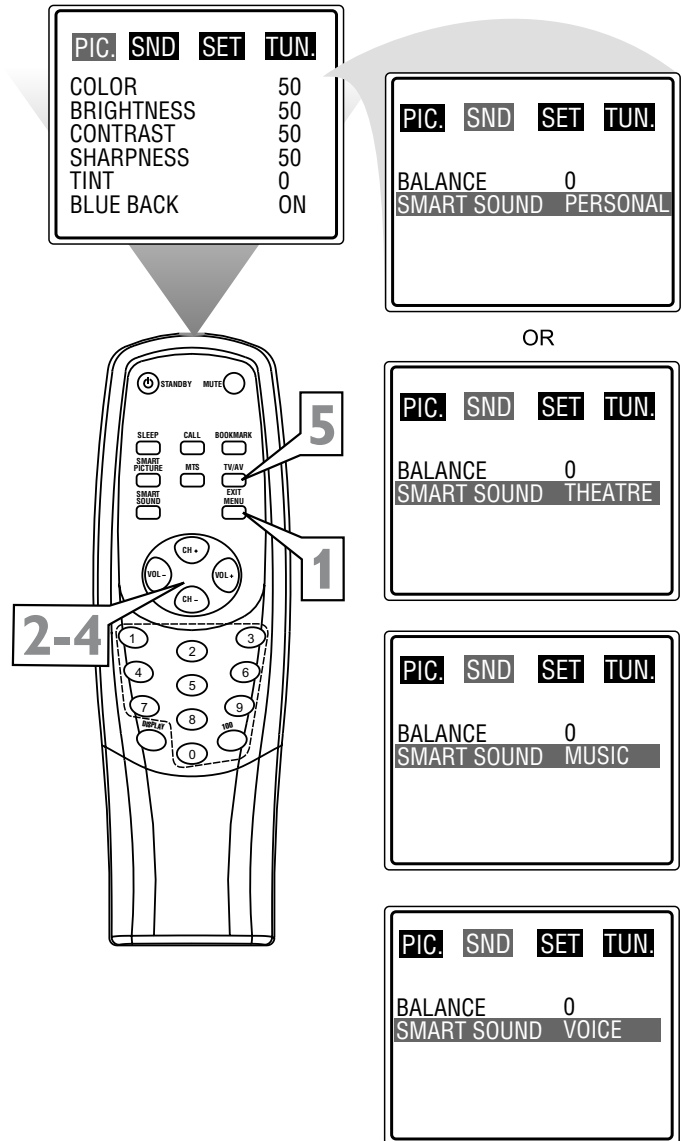

Helpful Hint

You can choose a Smart Sound setting quickly by pressing the SMART SOUND button on the remote control.

Balance

You can adjust the balance to increase or decrease the relative volumes of the left and right sound channels.

- 1** Press **MENU** to show the on-screen menu.
- 2** Press **VOL+** or **VOL-** to select **SND (Sound)**.
- 3** Press **CH+** or **CH-** to highlight **BALANCE**.
- 4** Press **VOL+** or **VOL-** to adjust the balance.
- 5** Press **TV/AV/EXIT** to remove the menus from the screen.

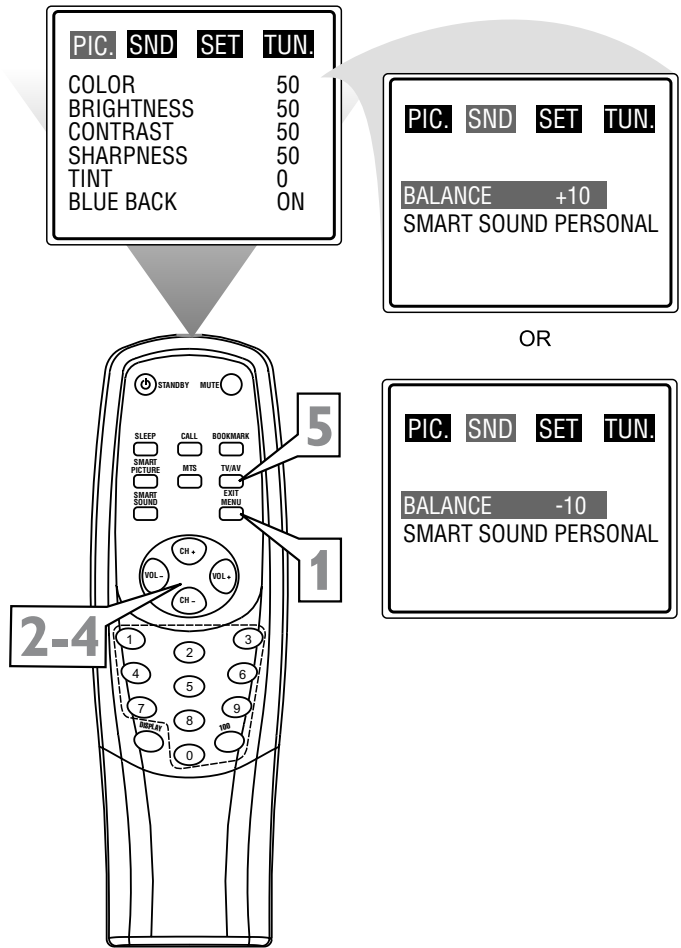

Stereo and Second Audio Program

Multi-channel Sound (MTS) broadcasts enhance TV viewing by bringing you programs with high fidelity stereo sound. MTS also provides an extra channel called the Second Audio Program (SAP), which broadcasters can use to transmit a second language or for other purposes.

1 Press **MTS** on the remote control to select **STEREO, MONO, SAP, or MONO+SAP**. All the options will be available only when the current TV channel is broadcasting that option. Channels will not always carry programs that have all the MTS options.

If **STEREO** appears on the screen when you select a channel, stereo broadcasting is available with the current TV program. You can hear sound from the left and right speakers of the TV.

If the broadcast is not strong or clear, stereo sound is not available. Press the MTS button to change to **MONO**. This should eliminate the noise.

If **MONO** appears on the screen when you choose a channel, Stereo is not available.

If **SAP** appears when you select a channel, Second Audio Program broadcasting is available for the current TV program. Press the MTS button to choose SAP and you may hear the program in a different language or some other audio.

If you choose **MONO+SAP** by pressing the MTS button, you will hear both the Second Audio Program and the regular **MONO** (monaural or single-channel) audio simultaneously.

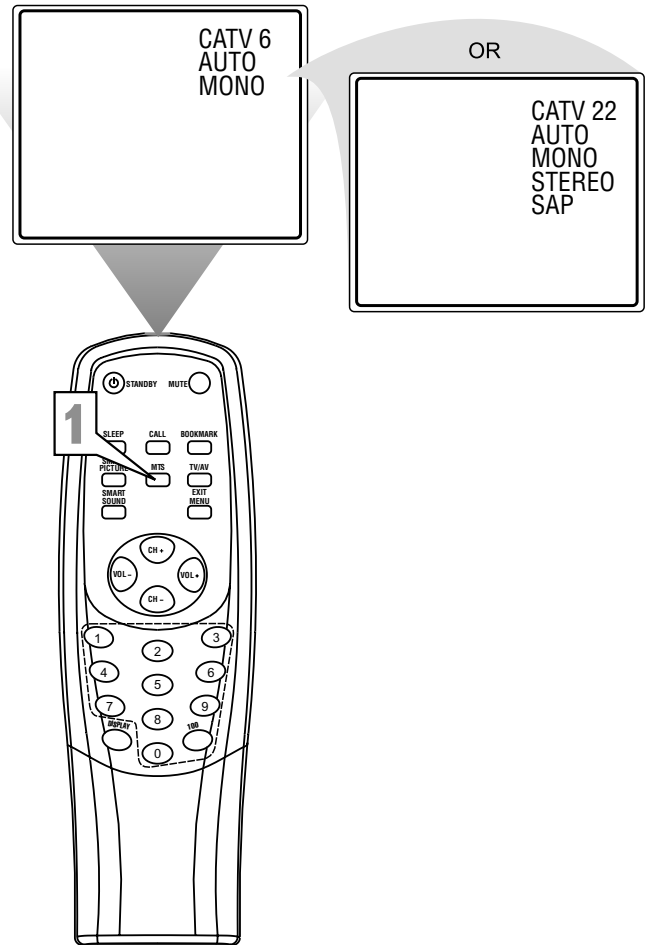



Helpful Hints

No Power

- Check the TV power cord. Disconnect the power cord from the power outlet for 10 seconds, then reinsert the plug into the outlet. Press the STANDBY button to turn on the TV again.
- Make sure the outlet is not on a wall switch.
- Make sure a fuse has not blown at the power outlet.

No Picture

- Check the antenna or Cable TV connections. Connect the antenna or Cable TV signal securely to the TV's 75 OHM ANTENNA INPUT jack on the rear of the TV.
- Set TV/CABLE correctly. Details are on page 11.
- Activate AUTO PROGRAM to find all available channels. Details are on page 12.
- Press TV/AV/EXIT on the remote control to select TV channels or a video source (VIDEO 1 or VIDEO 2). Use VIDEO 1 and VIDEO 2 to view material on other equipment (Camcorder, VCR, etc.) that is connected to the TV's Audio and Video In jacks.

No Sound

- Press the VOL+ and VOL- buttons to adjust the volume.
- Press the MUTE button on the remote control to cancel or restore the volume.

Remote Control does not work.

- Check the batteries. If necessary, replace them with two AAA heavy duty (zinc chloride) or alkaline batteries.
- Clean the remote control as well as the remote control sensor on the front of the TV.
- Check the TV power cord. Disconnect the power cord from the power outlet for 10 seconds, then reinsert the plug into the outlet. Press the STANDBY button to turn on the TV again.
- Make sure the outlet is not on a wall switch.
- Make sure a fuse has not blown at the power outlet.
- Always point the remote control toward the front of the TV (toward the remote sensor).

TV displays wrong channel or no channels.

- Repeat channel selection.
- Add the channel number(s) into the TV's memory. Use ADD/ERASE as described on page 14.
- Make sure TV/CABLE is set correctly. Details are on page 11. Then activate AUTO PROGRAM to set up all available channels. Details are on page 12.



Care and Cleaning

WARNING concerning stationary images on the TV screen: Do not leave fixed images on the screen for extended periods of time. This can cause uneven aging of the picture tube.

Normal use of the TV should involve viewing of programs that have constantly moving or changing images. Do not leave non-moving images on screen for extended periods of time. Do not display the same images too frequently; subtle “ghost” images can be left on the picture tube. Sources of stationary images may be Laser discs, video games, Compact Discs Interactive (CD-i), or paused Digital Video Discs (DVDs) or videotapes.

Here are some common examples of stationary images:

- **DVD menus** - listings of DVD content.
- **Letterbox black bars** - appear at the top and bottom of the TV screen when a wide screen (16:9) movie is viewed on a TV with standard (4:3) aspect ratio. This is available with some DVDs.
- **Video-game images and scoreboards**
- **Television station logos** - These cause a problem if they are bright and stationary. Moving or low-contrast graphics are less likely to damage the picture tube.
- **Stock-market tickers** - may appear at the bottom of the TV screen if the TV programming covers this news.
- **Shopping channel logos, pricing displays** - These may be bright and may appear constantly during the show. These are usually in the same location on the TV screen.

TV LOCATION

- To avoid cabinet warping, cabinet color changes, and an increased chance of TV failure, do not place the TV where temperatures can become excessively hot (for example, in direct sunlight or near a heating appliance).
- Allow a free flow of air around the TV.

CLEANING

- To avoid possible shock hazard, remove the TV's power cord from the electrical outlet before cleaning.
- Regularly dust the TV with a dry, non-scratching duster.
- When cleaning the TV, take care not to scratch or damage the screen surface. Avoid wearing jewelry or using anything abrasive. Do not use household cleaners. Wipe the screen with a clean cloth dampened with water. Use even, easy, vertical strokes when cleaning.
- Gently wipe the cabinet surfaces with a clean cloth or a sponge dampened in a solution of cool, clear water and a mild soap or detergent. Use a clean, dry cloth to dry the wiped surfaces.
- Occasionally vacuum the vents on the rear of the TV.
- Never use thinners, insecticide sprays, or other chemicals on or near the cabinet. They may blemish the cabinet permanently.

Glossary



Audio/Video Inputs • Jacks (standard RCA) on the rear of the TV to which you connect accessory devices. These jacks receive picture and sound from equipment such as a DVD Player, VCR, Camcorder, etc.

Auto Program • Scans all available channels from regular antenna or Cable TV signals and stores only active stations in the TV's memory.

Closed Captioning • The broadcast feature that lets you read the voice content of television programs on the TV screen. Designed to help the hearing impaired, Closed Captioning shows dialog, activity, and conversations while a TV program is in progress.

Coaxial Cable • A single solid wire normally matched with a metal plug (F-type) end connector that screws (or pushes) directly onto a 75-ohm input on the television or VCR.

Menu • An on-screen list of controls available for adjustment.

On-screen Displays (OSD) • Messages that help you set up features (color adjustment or channel programming, for example).

Remote Control Sensor • The window or opening on the front of the TV through which infrared remote control signals are received.

Index



Add/Erase Channels	14	Parental Controls	
Antenna Connection	6	Blocking Options	26
Audio jacks	7	Movie Ratings	24
Auto Program	12	Secret Code	23
		TV Ratings	25
Balance	29	Understanding Parental Control	22
Battery Installation	8	Picture	15
Blue Back (background)	15		
Brightness	15	Registration	2
		Remote Control	8-9
Cable TV Connection	5		
Channel Setup	12	Safety	3
Child Lock	27	Second Audio Program (SAP)	30
Cleaning	32	Sharpness	15
Clock	17	Sleep Timer	21
Closed Captions	20	SmartPicture	16
Color	15	SmartSound	28
Contrast	15	Stereo	30
Factory Service	34-35	Tint	15
		TV/Cable TV	11
Glossary	33		
Helpful Hints	31	Warranty	36
Language	10		
Manual Channel Tuning	13		
Mono	30		
MTS	30		
On-Timer	18		
Off-Timer	19		



FACTORY SERVICE LOCATIONS



NOTE: Magnavox has chosen Philips Factory Service as its preferred, authorized servicer. Please contact a Philips Factory Service Center. If you reside in one of our Philips Factory Service Branch areas, you can contact the nearest Service Branch to obtain efficient and expedient repair for your product. If your product is In-Warranty, you should have proof-of-purchase to ensure No Charge Service. For Out-of-Warranty service, call the location nearest you.

NOTA: Si vous résidez dans une des régions desservies par une succursale de service après vente du fabricant Philips (voir liste ci-dessous), vous pourrez contacter la branche de service après vente la plus près de chez vous pour obtenir un service après vente rapide et efficace. Si le produit est sous garantie, il suffira de présenter une preuve d'achat pour bénéficier d'un service sans frais. Pour les produits non couverts par la garantie, contactez le centre le plus près de chez vous.

NOTA: Si Ud. reside en una de nuestras zonas para sucursales Philips de servicio al de fábrica (ver directorio más abajo), Ud. puede comunicarse con la sucursal de servicio más cercana para obtener una reparación oportuna y eficaz de su producto. Si su producto está todavía bajo garantía, Ud. debe presentar comprobante de compra para no ocasionar ningunos cargos por servicio. Para servicio después del vencimiento de la garantía, llame al lugar más cercano de los abajo indicados.

In Canada

To obtain efficient and expedient carry-in, mail-in, or in-home service for your product, please contact Magnavox at:

1-800-661-6162 (French speaking)
 1-800-705-2000 (English or Spanish speaking)

Au Canada

Comment obtenir le service après-vente pour les produits apportés ou envoyés par la poste à notre centre de service ou le service à domicile, veuillez contacter Magnavox á:

1-800-661-6162 (Francophone)
 1-800-705-2000 (Anglais ou Espagnol)

En el Canadá

Cómo recibir servicio eficiente para su producto, en persona, por correo o a domicilio, favor de comunicarse con Magnavox al:

1-800-661-6162 (francófono)
 1-800-705-2000 (Inglés o Español))

FACTORY SERVICE LOCATIONS



QUALITY SERVICE IS AS CLOSE AS YOUR TELEPHONE! SIMPLY LOOK OVER THE LIST BELOW FOR THE NUMBER OF A FACTORY SERVICE CENTER NEAR YOU. MAGNAVOX HAS CHOSEN PHILIPS FACTORY SERVICE AS ITS PREFERRED, AUTHORIZED SERVICER. YOUR PRODUCT WILL RECEIVE EFFICIENT AND EXPEDIENT CARRY-IN, MAIL-IN, OR IN-HOME SERVICE, AND YOU WILL RECEIVE PEACE OF MIND, KNOWING YOUR PRODUCT IS BEING GIVEN THE EXPERT ATTENTION OF PHILIPS' FACTORY SERVICE.

COMMENT OBTENIR NOTRE SERVICE APRÈS VENTE RAPIDE ET EFFICACE SOIT PAR COURRIER, À DOMICILE, OU EN SE PRÉSENTANT À UN CENTRE DE SERVICE PHILIPS. PLUS DE 600 CENTRES DE RÉCEPTION DE PRODUITS À RÉPARER À TRAVERS LE PAYS: CONTACTER LE CENTRE DE SERVICE AUX CONSOMMATEURS LE PLUS PROCHE POUR SAVOIR L'EMPLACEMENT DE CES DÉPÔTS DANS UN RAYON DE 50 À 75 MILES (80 KM À 120 KM) DU CENTRE DE SERVICE LOCAL.

CÓMO OBTENER UN SERVICIO OPORTUNO Y EFICIENTE POR CORREO, EN CASA O EN PERSONA PARA SU PRODUCTO A TRAVÉS DE UN CENTRO PHILIPS DE SERVICIO. MAS DE 600 SITIOS POR TODO EL PAIS PARA LA RECEPCION DE PRODUCTOS NECESITADOS DE REPARACIONES: COMUNICARSE CON EL CENTRO DE SERVICIO DE FABRICA MAS CERCANO PARA ESTOS LUGARES DENTRO DE UN RADIO DE 80 A 120 KM (50 A 75 MILLAS) DEL CENTRO DE SERVICIO LOCAL.

ATLANTA

Philips Factory Service
550 Franklin Road., Suite F
Marietta, GA 30067
800-273-1501

TAMPA

Philips Factory Service
1911 US Highway 301 North, Suite 100
Tampa, FL 33619
800-442-2027

SAN FRANCISCO

Philips Factory Service
681 East Brokaw Rd.
San Jose, CA 95112
800-300-9013

HOUSTON

Philips Factory Service
1110 N. Post Oak Rd., Suite 100
Houston, TX 77055
800-952-3254

CLEVELAND

Philips Factory Service
950 Keynote Circle
Brooklyn Heights, OH 44131
800-331-7037

DETROIT

Philips Factory Service
25173 Dequindre
Madison Heights, MI 48071
800-438-1398

DALLAS

Philips Factory Service
415 N. Main Street, #107
Euless, TX 76040
800-952-3254

LOS ANGELES

Philips Factory Service
20930 Bonita, Ste.V
Carson, CA 90746
800-300-9013

CHICAGO

Philips Factory Service
1279 W. Hamilton Pkwy.
Itasca, IL 60143
800-531-2922

KNOXVILLE

Philips Factory Service
One Philips Drive
Building 2
Knoxville, TN 37914
800-821-1767

PHILADELPHIA

Philips Factory Service
354 Dunks Ferry Rd.
Bensalem, PA 19020
800-847-9320

LIMITED WARRANTY

COLOR TELEVISION

90 Days Free Labor

One Year Parts Exchange

This product can be repaired in-home.

WHO IS COVERED?

You must have proof of purchase to receive warranty service. A sales receipt or other document showing that you purchased the product is considered proof of purchase.

WHAT IS COVERED?

Warranty coverage begins the day you buy your product. For 90 days thereafter, all parts will be repaired or replaced free, and labor is free. From 90 days to one year from the day of purchase, all parts will be repaired or replaced free, but you pay for all labor charges. After one year from the day of purchase, you pay for the replacement or repair of all parts, and for all labor charges.

All parts, including repaired and replaced parts, are covered only for the original warranty period. When the warranty on the product expires, the warranty on all replaced and repaired parts also expires.

WHAT IS EXCLUDED?

Your warranty does not cover:

- labor charges for installation or setup of the product, adjustment of customer controls on the product, and installation or repair of antenna systems outside of the product.
- product repair and/or part replacement because of misuse, accident, unauthorized repair or other cause not within the control of Magnavox.
- reception problems caused by signal conditions or cable or antenna systems outside the unit.
- a product that requires modification or adaptation to enable it to operate in any country other than the country for which it was designed, manufactured, approved and/or authorized, or repair of products damaged by these modifications.
- incidental or consequential damages resulting from the product. (Some states do not allow the exclusion of incidental or consequential damages, so the above exclusion may not apply to you. This includes, but is not limited to, prerecorded material, whether copyrighted or not copyrighted.)
- a product used for commercial or institutional purposes.

WHERE IS SERVICE AVAILABLE?

Warranty service is available in all countries where the product is officially distributed by Magnavox. In countries where Magnavox does not distribute the product, the local Magnavox service organization will attempt to provide service (although there may be a delay if the appropriate spare parts and technical manual(s) are not readily available).

MAKE SURE YOU KEEP...

Please keep your sales receipt or other document showing proof of purchase. Attach it to this owner's manual and keep both nearby. Also keep the original box and packing material in case you need to return your product.

BEFORE REQUESTING SERVICE...

Please check your owner's manual before requesting service. Adjustments of the controls discussed there may save you a service call.

TO GET WARRANTY SERVICE IN U.S.A., PUERTO RICO, OR U.S. VIRGIN ISLANDS...

Contact a Magnavox factory service center (see enclosed list) or authorized service center to arrange repair.

(In U.S.A., Puerto Rico, and U.S. Virgin Islands, all implied warranties, including implied warranties of merchantability and fitness for a particular purpose, are limited in duration to the duration of this express warranty. But, because some states do not allow limitations on how long an implied warranty may last, this limitation may not apply to you.)

TO GET WARRANTY SERVICE IN CANADA...

Please contact Magnavox at:

1-800-705-2000

(In Canada, this warranty is given in lieu of all other warranties. No other warranties are expressed or implied, including any implied warranties of merchantability or fitness for a particular purpose. Magnavox is not liable under any circumstances for any direct, indirect, special, incidental or consequential damages, howsoever incurred, even if notified of the possibility of such damages.)

REMEMBER...

Please record below the model and serial numbers found on the product. Also, please fill out and mail your warranty registration card promptly. It will be easier for us to notify you if necessary.

MODEL # _____

SERIAL # _____

This warranty gives you specific legal rights. You may have other rights which vary from state/province to state/province.