

DVD VIDEO PLAYER

DVP5980K

Thank you for choosing Philips.

Need help fast?

*Read your Quick Start Guide and/or User Manual first for quick tips
that make using your Philips product more enjoyable.*

***Register your product and get support
at www.philips.com/welcome***



PHILIPS

México

NOM-135-

Es necesario que lea cuidadosamente su instructivo de manejo.



Descripción: **DVP5980K/55**
Modelo: **DVD Player**
Alimentación: **110 - 240V; 50/60Hz**
Consumo: **< 10W**
Importador: **Philips Mexicana, S.A. de C.V.**
Domicilio: **Av. La Palma No.6,
Col. San Fernando, La Herradura
Huixquilucan, Edo de Mexico
C.P. 52784, Mexico**

Localidad y Tel.: **Tel. 52 69 90 00**

Exportador:
País de Origen:

Nº de Serie: _____

**LEA CUIDADOSAMENTE ESTE INSTRUCTIVO
ANTES DE USAR SU APARATO.**

AVISO IMPORTANTE

Philips Mexicana, S.A. de C.V. no se hace responsable por daños o desperfectos causados por:

- Maltrato, descuido o mal uso, presencia de insectos o roedores (cucarachas, ratones etc.).
- Cuando el aparato no haya sido operado de acuerdo con el instructivo del uso, fuera de los valores nominales y tolerancias de las tensiones (voltaje), frecuencia (ciclaje) de alimentación eléctrica y las características que deben reunir las instalaciones auxiliares.
- Por fenómenos naturales tales como: temblores, inundaciones, incendios, descargas eléctricas, rayos etc. o delitos causados por terceros (choques asaltos, riñas, etc.).

Index

The apparatus shall not be exposed to dripping or splashing and that no objects filled with liquids, such as vases, shall be placed on apparatus.

Due to the inconsistency of disc formats provided by various disc manufacturers, your DVD system may require a playability enhancement or upgrade. As DVD technology advances, these enhancements will become common and will be easy to complete.
Go to www.philips.com/support for software upgrade.

'CONSUMERS SHOULD NOTE THAT NOT ALL HIGH DEFINITION TELEVISION SETS ARE FULLY COMPATIBLE WITH THIS PRODUCT AND MAY CAUSE ARTIFACTS TO BE DISPLAYED IN THE PICTURE. IN CASE OF 525 OR 625 PROGRESSIVE SCAN PICTURE PROBLEMS, IT IS RECOMMENDED THAT THE USER SWITCH THE CONNECTION TO THE 'STANDARD DEFINITION' OUTPUT. IF THERE ARE QUESTIONS REGARDING TV SET COMPATIBILITY WITH THIS MODEL 525p AND 625p DVD PLAYER, PLEASE CONTACT OUR CUSTOMER SERVICE CENTER.'

English ----- 6

Español ----- 56

Português ----- 106

English

Español

Português

CUIDADO! Evite o uso prolongado do aparelho com volume superior a 85 decibéis, pois isto poderá prejudicar a sua audição.

- A tabela abaixo lista alguns exemplos de situações e respectivos níveis de pressão sonora em decibéis.

Nível de Decibéis	Exemplo
30	Biblioteca silenciosa, sussurros leves.
40	Sala de estar, refrigerador, quarto longe de trânsito.
50	Trânsito leve, conversa normal, escritório silencioso.
60	Ar-condicionado a uma distância de 6m, máquina de costura.
70	Aspirador de pó, secador de cabelo, restaurante ruidoso.
80	Tráfego médio de cidade, coletor de lixo, alarme de despertador a uma distância de 60 cm.
OS RUIDOS ABAIXO PODEM SER PERIGOSOS EM CASO DE EXPOSIÇÃO CONSTANTE	
90	Metrô, motocicleta, tráfego de caminhão, cortador de grama.
100	Caminhão de lixo, serra elétrica, furadeira pneumática.
120	Show de banda de rock em frente às caixas acústicas, trovão.
140	Tiro de arma de fogo, avião a jato
180	Lançamento de foguete.

- Informação cedida pela Deafness Research Foundation, por cortesia.

General Information

Environmental Information

All unnecessary packaging has been omitted. The packaging has been made easy to separate into two materials; cardboard (box) and polyethylene (bags, protective foam sheet).

Your DVD player consists of materials which can be recycled and reused if disassembled by a specialised company. Please observe the local regulations regarding the disposal of packaging materials, exhausted batteries and old equipment.



Manufactured under license from Dolby Laboratories, Dolby and the double-D symbol are trademarks of Dolby Laboratories.



Windows Media and the Windows logo are trademarks, or registered trademarks of Microsoft Corporation in the United States and/or other countries.



DivX Ultra Certified products: DivX, DivX Ultra Certified, and associated logos are trademarks of DivX, Inc. and are used under license.

For Customer Use:
Read carefully the information located at the bottom or rear of your DVD Video player and enter below the Serial No. Retain this information for future reference.

Model No. DVP 5980K
Serial No. _____

Laser Safety

This unit employs a laser. Due to possible eye injury, only a qualified service person should remove the cover or attempt to service this device.

NOTE:

Pictures shown maybe different between countries.

CAUTION:

WARNING LOCATION: ON THE BACKPLATE OF THE SET

NEVER MAKE OR CHANGE CONNECTIONS WITH THE POWER SWITCHED ON.

Specifications are subject to change without notice. Trademarks are the property of Koninklijke Philips Electronics N.V. or their respective owners.

HDMI

HDMI, and HDMI logo and High-Definition Multimedia Interface are trademarks or registered trademarks of HDMI licensing LLC.

This product incorporates copyright protection technology that is protected by method claims of certain U.S. patents and other intellectual property rights owned by Macrovision Corporation and other rights owners. Use of this copyright protection technology must be authorized by Macrovision Corporation, and is intended for home and other limited viewing uses only unless otherwise authorized by Macrovision Corporation. Reverse engineering or disassembly is prohibited.

LASER

Type	Semiconductor laser InGaAlP (DVD) AlGaAs (CD)
Wave length	658 nm (DVD) 790 nm (CD)
Output Power	7.0 mW (DVD) 10.0 mW (VCD/CD)
Beam divergence	60 degrees

Language Code

Abkhazian	6566	Inupiaq	7375	Pushto	8083
Afar	6565	Irish	7165	Russian	8285
Afrikaans	6570	Íslenska	7383	Quechua	8185
Amharic	6577	Italiano	7384	Raeto-Romance	8277
Arabic	6582	Ivrit	7269	Romanian	8279
Armenian	7289	Japanese	7465	Rundi	8278
Assamese	6583	Javanese	7486	Samoan	8377
Avestan	6569	Kalaallisut	7576	Sango	8371
Aymara	6589	Kannada	7578	Sanskrit	8365
Azerhijani	6590	Kashmiri	7583	Sardinian	8367
Bahasa Melayu	7783	Kazakh	7575	Serbian	8382
Bashkir	6665	Kernewek	7587	Shona	8378
Belarusian	6669	Khmer	7577	Shqip	8381
Bengali	6678	Kinyarwanda	8287	Sindhi	8368
Bihari	6672	Kirghiz	7589	Sinhalese	8373
Bislama	6673	Komi	7586	Slovensky	8373
Bokmål, Norwegian	7866	Korean	7579	Slovenian	8376
Bosanski	6683	Kuanyama; Kwanyama	7574	Somali	8379
Brezhoneg	6682	Kurdish	7585	Sotho; Southern	8384
Bulgarian	6671	Lao	7679	South Ndebele	7882
Burmese	7789	Latina	7665	Sundanese	8385
Castellano, Español	6983	Latvian	7686	Suomi	7073
Catalán	6765	Letzeburgesch;	7666	Swahili	8387
Chamorro	6772	Limburgan; Limburger	7673	Swati	8383
Chechen	6769	Lingala	7678	Svenska	8386
Chewa; Chichewa; Nyanja	7889	Lithuanian	7684	Tagalog	8476
中文	9072	Luxembourgish;	7666	Tahitian	8489
Chuang; Zhuang	9065	Macedonian	7775	Tajik	8471
Church Slav; Slavonic	6785	Malagasy	7771	Tamil	8465
Chuvash	6786	Magyar	7285	Tatar	8484
Corsican	6779	Malayalam	7776	Telugu	8469
Česky	6783	Maltese	7784	Thai	8472
Dansk	6865	Manx	7186	Tibetan	6679
Deutsch	6869	Maori	7773	Tigrinya	8473
Dzongkha	6890	Marathi	7782	Tonga (Tonga Islands)	8479
English	6978	Marshallese	7772	Tsonga	8483
Esperanto	6979	Moldavian	7779	Tswana	8478
Estonian	6984	Mongolian	7778	Türkçe	8482
Euskara	6985	Nauru	7865	Turkmen	8475
Ελληνικά	6976	Navaho; Navajo	7886	Twi	8487
Faroese	7079	Ndebele, North	7868	Uighur	8571
Français	7082	Ndebele, South	7882	Ukrainian	8575
Frysk	7089	Ndonga	7871	Urdu	8582
Fijian	7074	Nederlands	7876	Uzbek	8590
Gaelic; Scottish Gaelic	7168	Nepali	7869	Vietnamese	8673
Gallegan	7176	Norsk	7879	Volapuk	8679
Georgian	7565	Northern Sami	8369	Walloon	8765
Gikuyu; Kikuyu	7573	North Ndebele	7868	Welsh	6789
Guarani	7178	Norwegian Nynorsk;	7878	Wolof	8779
Gujarati	7185	Occitan; Provençal	7967	Xhosa	8872
Hausa	7265	Old Bulgarian; Old Slavonic	6785	Yiddish	8973
Herero	7290	Oriya	7982	Yoruba	8979
Hindi	7273	Oromo	7977	Zulu	9085
Hiri Motu	7279	Ossetian; Ossetic	7983		
Hrvatski	6779	Pali	8073		
Ido	7379	Panjabi	8065		
Interlingua (International)	7365	Persian	7065		
Interlingue	7365	Polski	8076		
Inuktitut	7385	Português	8084		

Contents

Care and Safety Information	
Setup	8
Cleaning discs	8
General Information	
Accessories supplied	9
Region codes.....	9
Connections	
Connecting to television	10~11
Using Composite Video jacks (CVBS).....	10
Using Component Video jacks (YPbPr).....	10
Using an accessory RF modulator	11
Connecting the power cord	12
Optional connections	
Connecting to a stereo system	13
Stereo system has right/left Audio In jacks	13
Connecting to a digital AV receiver	13
Receiver has a PCM, Dolby Digital or MPEG decoder	13
Connecting a USB Flash Drive or USB mass storage device	14
Using USB port	14
HDMI connections	
Connecting to a HDMI or DVI TV	15
Connecting to an Analog or Digital AV Receiver	16
Connecting to a HDMI/DVI TV via a HDMI Repeater	16
Product Overview	
Front and Rear panels	17
Remote Control	18
Getting Started	
Step 1: Inserting Batteries	19
Using the remote control to operate the system.....	19
Step 2: Finding your viewing channel	19
Step 3: Setting up Progressive Scan feature	20
Step 4: Selecting the matching color system	21
Step 5: Setting the language	22
On-screen display (OSD) language	22
Audio, Subtitle and Disc menu languages.....	22
Playback from Disc	
Playable discs	23
Supported formats.....	23
Playback Features	
Starting disc playback	24
Basic playback controls	24
Pausing playback.....	24
Selecting title/chapter/track.....	24
Stopping playback	24
Operations for video playback	25
Using the Disc Menu	25
Zooming in	25
Resuming playback from the last stopped point.....	25
Slow Motion.....	25
Forward / Reverse Searching	25
Viewing the disc playback information	26~28
Using the OSD menu	26
Title/Chapter/Track selection	26
Time Search	26
Audio/Subtitle.....	26
Angle.....	26
Time Display.....	27
Repeat.....	27
Repeat A-B.....	27
Preview.....	28

Contents

English

Viewing Audio CD playback information	28
Disc Go To / Track Go To / Track Selection.....	28
Repeat.....	28
Special DVD Features.....	29
Playing a Title.....	29
Changing the Audio Language.....	29
Subtitles.....	29
Special VCD and SVCD Feature	29
Playback Control (PBC)	29
Playing a DivX® disc.....	30
USB mass storage device	31
Compatibility of USB device	31
Playing from USB flash drive or USB memory card reader.....	32
Playing MP3/WMA/JPEG Picture CD.....	33-34
General Operation	33
Playback selection	33
Repeat.....	33
Playback with multi-angles (JPEG).....	34
Preview Function (JPEG)	34
Zoom picture (JPEG)	34
Playing MP3/WMA music and JPEG picture simultaneously	34
Karaoke Operations	
Playing Karaoke disc	35
General Operation	35
Vocal.....	35
Karaoke Menu.....	35
DVD Menu Options	
Using the General setup menu.....	36~37
Locking / Unlocking the disc for viewing.....	36
OSD Language.....	36
Sleep	37
Lip Sync	37
Volume.....	37
DivX® VOD registration code.....	37
Using the Audio setup menu	38~40
Analog Output	38
Digital Audio Setup.....	38~39
Sound Mode.....	40
CD Upsampling.....	40
Night Mode – turning on/off	40
Using the Video setup menu.....	41~45
TV Type.....	41
Setting the TV Display	41
Progressive.....	42
Picture Setting.....	42~43
HD JPEG	43
HDMI Video Setup.....	44~45
Using the Preference setup menu	46~48
Subtitle / Audio / Disc Menu	46
Parental	46~47
PBC.....	47
MP3/JPEG Menu.....	47
Changing the Password.....	48
Setting the DivX® subtitle font.....	48
Restoring to the original settings.....	48
Others	
Software Upgrade.....	49
Troubleshooting	50~52
Specifications	53
Frequently Asked Questions (USB)	54
Glossary	55

Care and Safety Information

DANGER!

High voltage! Do not open the device. You run the risk of getting an electric shock.

The machine does not contain any user-serviceable parts. Please leave all maintenance work to qualified personnel.

Setup

Finding a suitable location

- Place the set on a flat, hard and stable surface. Do not place the set on a carpet.
- Do not put any equipment or heavy objects on top of the set.
- Do not position the set on top of other equipment that might heat it up (such as receiver or amplifier).
- Do not put anything under the set (such as CDs, magazines).
- Install this unit near the AC outlet and where the AC power plug can be reached easily.

Space for ventilation

- Place the apparatus in a location with adequate ventilation to prevent internal heat build up. Allow at least 10 cm (4.0") clearance from the rear and the top of the set and 5cm (2.0") from the left and right to prevent overheating.

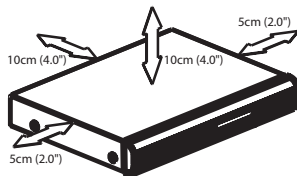

Avoid high temperatures, moisture, water and dust

- Apparatus shall not be exposed to dripping or splashing.
- Do not place any sources of danger on the apparatus (such as liquid filled objects, lighted candles).

Cleaning discs

Some problems occur because the disc inside the player is dirty (frozen picture, sound disruptions, picture distortions). To avoid these problems, discs should be cleaned on a regular basis.

To clean a disc, use a micro fibre cleaning cloth and wipe the disc from the center to the edge in a straight line.

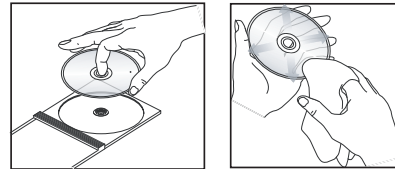

CAUTION!

Do not use solvents such as benzene, thinner, commercially available cleaners, or anti-static sprays intended for analog discs. Since the optical unit (laser) of the DVD player operates at a higher power than regular DVD or CD players, cleaning CDs intended for DVD or CD players may damage the optical unit (laser). Therefore, refrain from using a cleaning CD.

General Information

Accessories supplied

HDMI cable

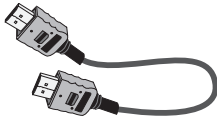

Composite video cable (yellow) and audio cables (white, red)

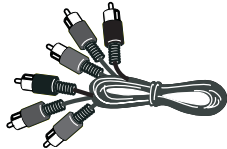

Remote control and two AAA batteries



AC Power Cord















Region codes

This DVD player is designed to support the Region Management System. Check the regional code number on the disc package. If the number does not match the player's region number (see table below), the player may be unable to playback the disc.

Tips:

- It may not be possible to play CD-R/RW or DVD-R/RW in all cases due to the type of disc or condition of the recording.
- If you are having trouble playing a certain disc, remove the disc and try a different one. Improper formatted disc will not played on this DVD player.

Region	Discs that can be played	
U.S.A. and Canada regions		
U.K and Europe regions		
Asia Pacific, Taiwan, Korea		
Australia, New Zealand, Latin America		
Russia and India regions		
China, Calcos Islands, Walls and Futuna Islands		

Connections

Connecting to television

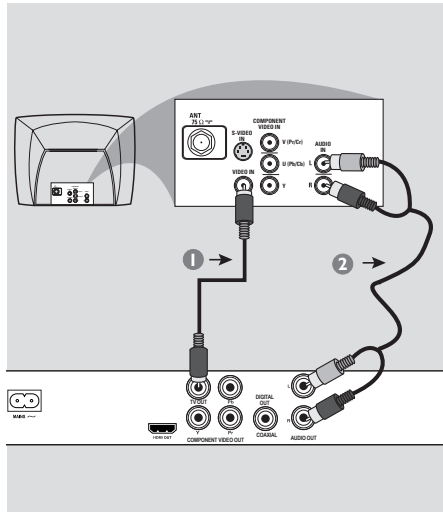

IMPORTANT!

- You only need to make one video connection from the following options, depending on the capabilities of your television.
- Connect the DVD player directly to the television.

Using Composite Video jacks (CVBS)

- 1 Use the composite video cable (yellow) to connect the DVD player's **TV OUT (CVBS)** jack to the video input jack (or labeled as A/V In, Video In, Composite or Baseband) on the television (cable supplied).
- 2 To hear sound of this DVD player through your television, use the audio cables (white/red) to connect **AUDIO OUT (L/R)** jacks of the DVD player to the corresponding **AUDIO IN** jacks on the television (cable supplied).

TIPS: Before making or changing any connections, make sure that all the devices are disconnected from the power outlet.

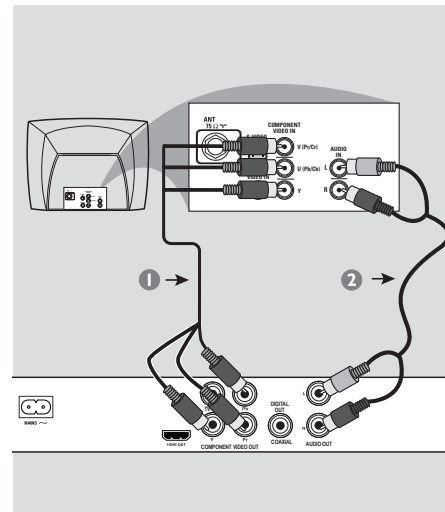

IMPORTANT!

- The progressive scan video quality is only possible when using **YPbPr** and a progressive scan television is required.

Using Component Video jacks (YPbPr)

- 1 Use the component video cables (red/blue/green) to connect the DVD player's **YPbPr** jacks to the component video input jacks (or labeled as YPbPr) on the television (cable not supplied).
- 2 To hear sound of this DVD player through your television, use the audio cables (white/red) to connect **AUDIO OUT (L/R)** jacks of the DVD player to the corresponding **AUDIO IN** jacks on the television (cable supplied).
- 3 Proceed to page 20 for detailed progressive scan setup.

Connections (continued)

English

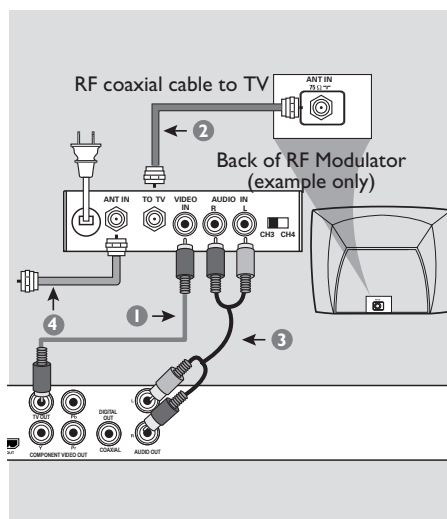

IMPORTANT!

– If your television only has a single Antenna In jack (or labeled as 75 ohm or RF In,) you will need an RF modulator in order to view the DVD playback on the television. See your electronics retailer or contact Philips for details on RF modulator availability and operations.

Using an accessory RF modulator

- 1 Use the composite video cable (yellow) to connect the DVD player's **TV OUT** (CVBS) jack to the video input jack on the RF modulator.
- 2 Use the RF coaxial cable (not supplied) to connect **ANTENNA OUT** or **TO TV** jack on the RF modulator to the **ANTENNA IN** jack on the television.

- 3 To hear sound of this DVD player through your TV, use the audio cables (white/red) to connect **AUDIO OUT** (L/R) jacks of the DVD player to the corresponding **AUDIO IN** jacks on the RF modulator (cable supplied).
- 4 Connect the Antenna or Cable TV service signal to the **ANTENNA IN** or **RF IN** jack on the RF modulator. (It may have been connected to your TV previously. Disconnect it from the TV).

TIPS: Before making or changing any connections, make sure that all the devices are disconnected from the power outlet.

11

Connections (continued)

Connecting the power cord

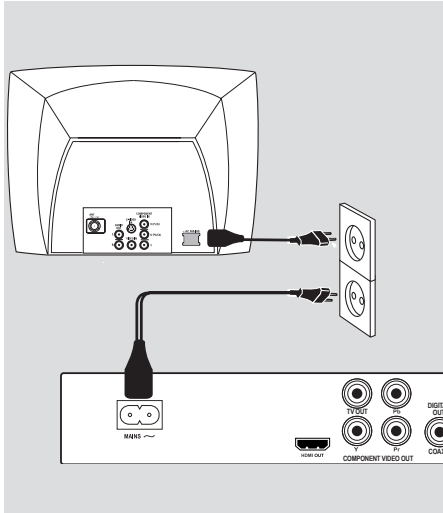

After everything is connected properly, plug in the AC power cord to the power outlet.

Never make or change any connections with the power switched on.

When no disc is loaded, **press STANDBY-ON on the DVD player front panel.**
“NO DISC” may appear on the display panel.

TIPS: Before making or changing any connections, make sure that all the devices are disconnected from the power outlet.

Optional connections

Connecting to a stereo system

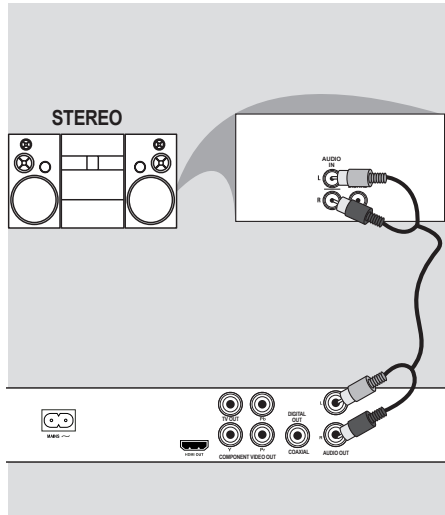

Stereo system has right/ left Audio In jacks

- 1 Select one of the video connections (CVBS VIDEO IN or COMPONENT VIDEO IN) depending on the options available on your television.
- 2 Use the audio cables (white/red) to connect AUDIO OUT (L/R) jacks of the DVD Player to the corresponding AUDIO IN jacks on the stereo system (cable supplied).

Connecting to a digital AV receiver

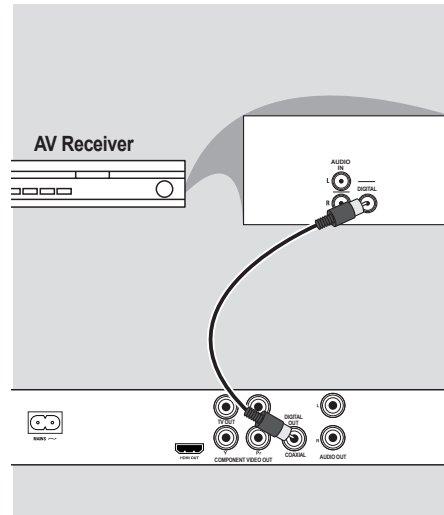

Receiver has a PCM, Dolby Digital or MPEG decoder

- 1 Select one of the video connections (CVBS VIDEO IN or COMPONENT VIDEO IN) depending on the options available on your television.
- 2 Connect the COAXIAL socket of the DVD player to the corresponding Digital Audio In jack on your receiver (cable not supplied).
- 3 Set the DVD player's digital output to PCM-Only or ALL depending on the capabilities of your receiver (see page 39 {Digital Output}).

Tip:

– If the audio format of the Digital Output does not match the capabilities of your receiver, the receiver will produce a strong, distorted sound or no sound at all.

TIPS: Before making or changing any connections, make sure that all the devices are disconnected from the power outlet.

Optional connections (continued)

Connecting a USB Flash Drive or USB mass storage device

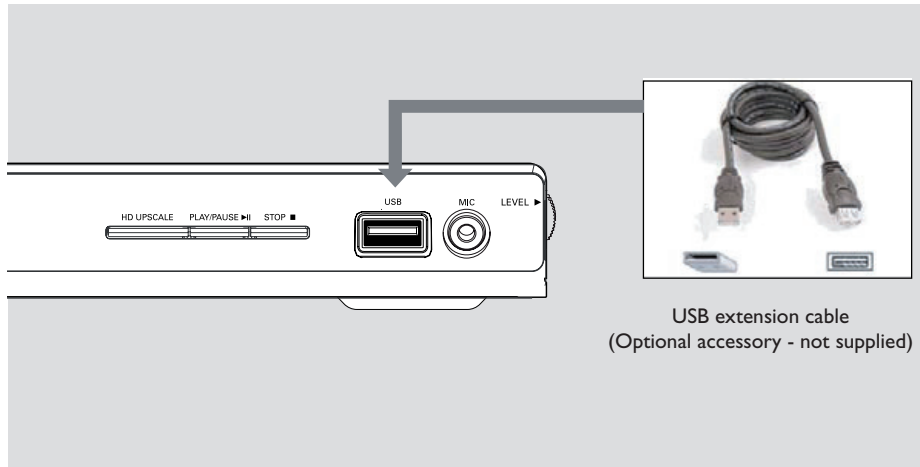

Using USB port

You can only view the content of following supported USB devices through this DVD player.

- 1 Connect the supported USB device directly to the USB port on the front panel (as shown on the above illustration).
- 2 Press **USB** button on the remote control in order to view the files stored in the supported USB device.
- 3 Stop the playback before removing the supported USB device from the USB port.

Tips:

- The USB port supports playback of JPEG/MP3/WMA files.
- Not all Portable audio/video players and Digital cameras are supported.
- While connected to a card reader, only one card can be read at the same time.
- If non-supported USB device is plugged in, 'Device Not Supported' will be displayed.
- If the USB device does not fit into the USB port, a USB extension cable is required.
- The format FAT16, FAT32 can be supported by USB and not NTFS.

TIPS: Before making or changing any connections, make sure that all the devices are disconnected from the power outlet.

HDMI connections

English

Connecting to a HDMI or DVI TV

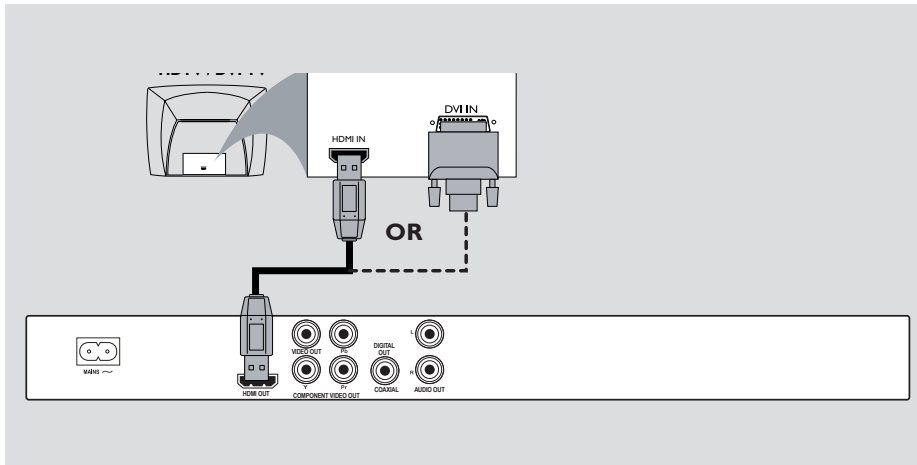

IMPORTANT!

- HDMI connects untouched and uncompressed digital transmission for the highest and crispest sound or image quality.
- It has plug and play capability using only one HDMI cable for both audio / video output.

- 1 Use a HDMI cable (supplied) to connect the DVD player's **HDMI OUT** to HDMI IN on the HDMI TV.

To hear sound via TV only,

- 2 Set the DVD player's { HDMI Audio Setup – On } for HDMI connection (see Digital Audio Setup – HDMI Audio Setup for detail).

IMPORTANT!

- If your TV has a DVI IN socket, you need a HDMI-DVI adapter cable to connect the HDMI OUT socket on the DVD player.
- This HDMI-DVI cable has only video output capability.

- 1 Use a HDMI-DVI cable (not supplied) to connect the DVD player's **HDMI OUT** to DVI IN on the DVI TV.

Tip:

- To hear sound from the DVD player, use one of the audio connection on next page as there will be no audio output for DVI TV.

TIPS: Before making or changing any connections, make sure that all the devices are disconnected from the power outlet.

HDMI connections (continued)

Connecting to an Analog or Digital AV Receiver

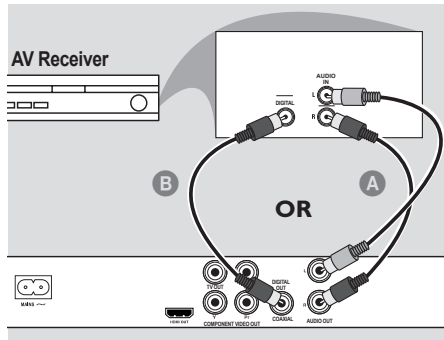

- Use a HDMI cable (supplied) or HDMI-DVI cable (not supplied) to connect the DVD player's **HDMI OUT** to HDMI/DVI IN on the HDTV or DVI TV.
- To hear sound via Audio Out L/R or multi-channels,**
- Use the audio cables (white/red) to connect AUDIO OUT (L/R) of the DVD Player to the AV receiver Audio In (cable supplied).
- Set the DVD player's {HDMI Audio Setup – Off} (see page 39).

OR

To hear sound via Coaxial/Digital Out,

- Connect the COAXIAL Digital Out of the DVD player to the Digital Audio In on the AV receiver (cable not supplied).
- Set the DVD player's {Digital Output – ALL} and {HDMI Audio Setup – Off} (see page 39).

Connecting to a HDMI/DVI TV via a HDMI Repeater

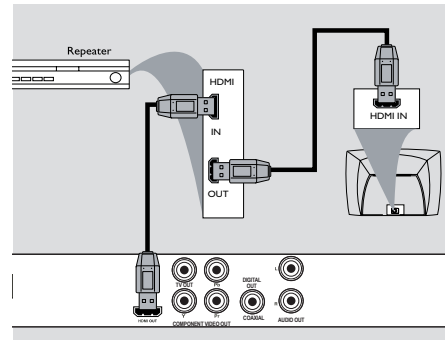

- Use a HDMI cable (supplied) to connect the DVD player's **HDMI OUT** to HDMI IN on the HDMI repeater.
- Use another cable (not supplied) to connect HDMI OUT of the HDMI repeater to the HDMI/DVI IN on a HDMI/DVI TV.
- Set the DVD player's { HDMI Audio Setup – On } for HDMI connection (see Digital Audio Setup – HDMI Audio Setup for detail).

Tips:

- During HDMI connection, the DVD player will turn into HDMI mode automatically.
- Proceed to page 44-45 for detailed HDMI Video setup.

TIPS: Before making or changing any connections, make sure that all the devices are disconnected from the power outlet.

Product Overview

English

Front and Rear Panels

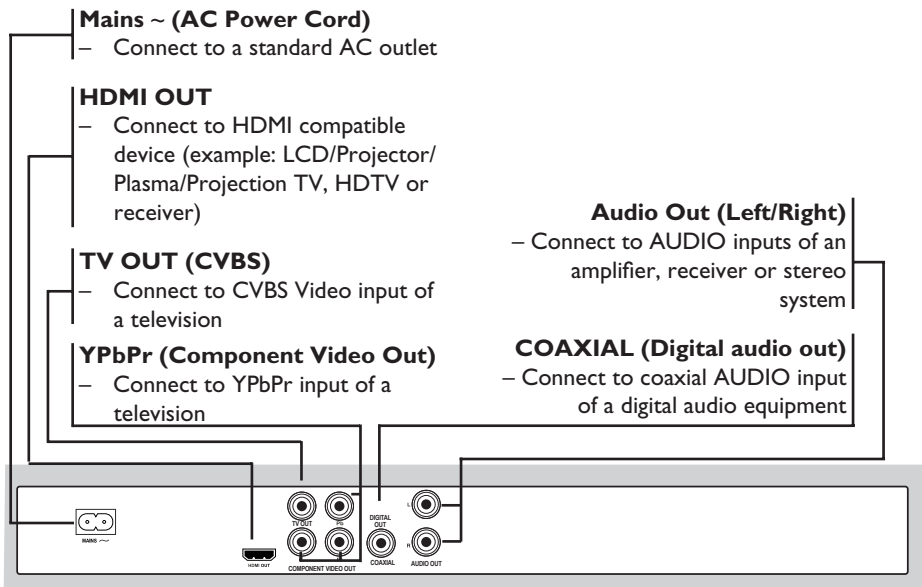
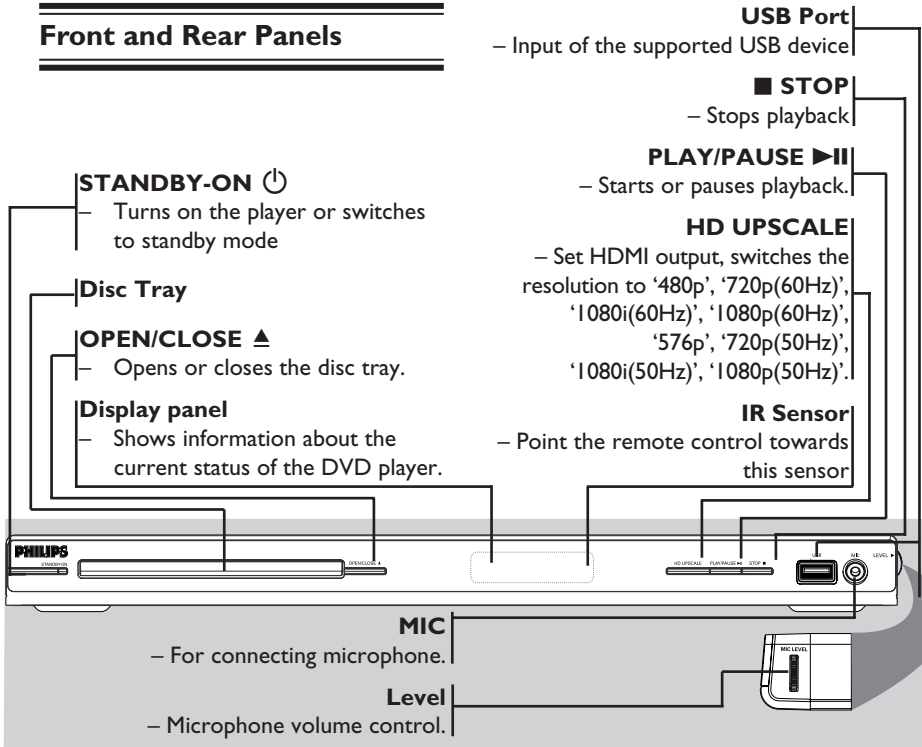

Product Overview (continued)

Remote Control

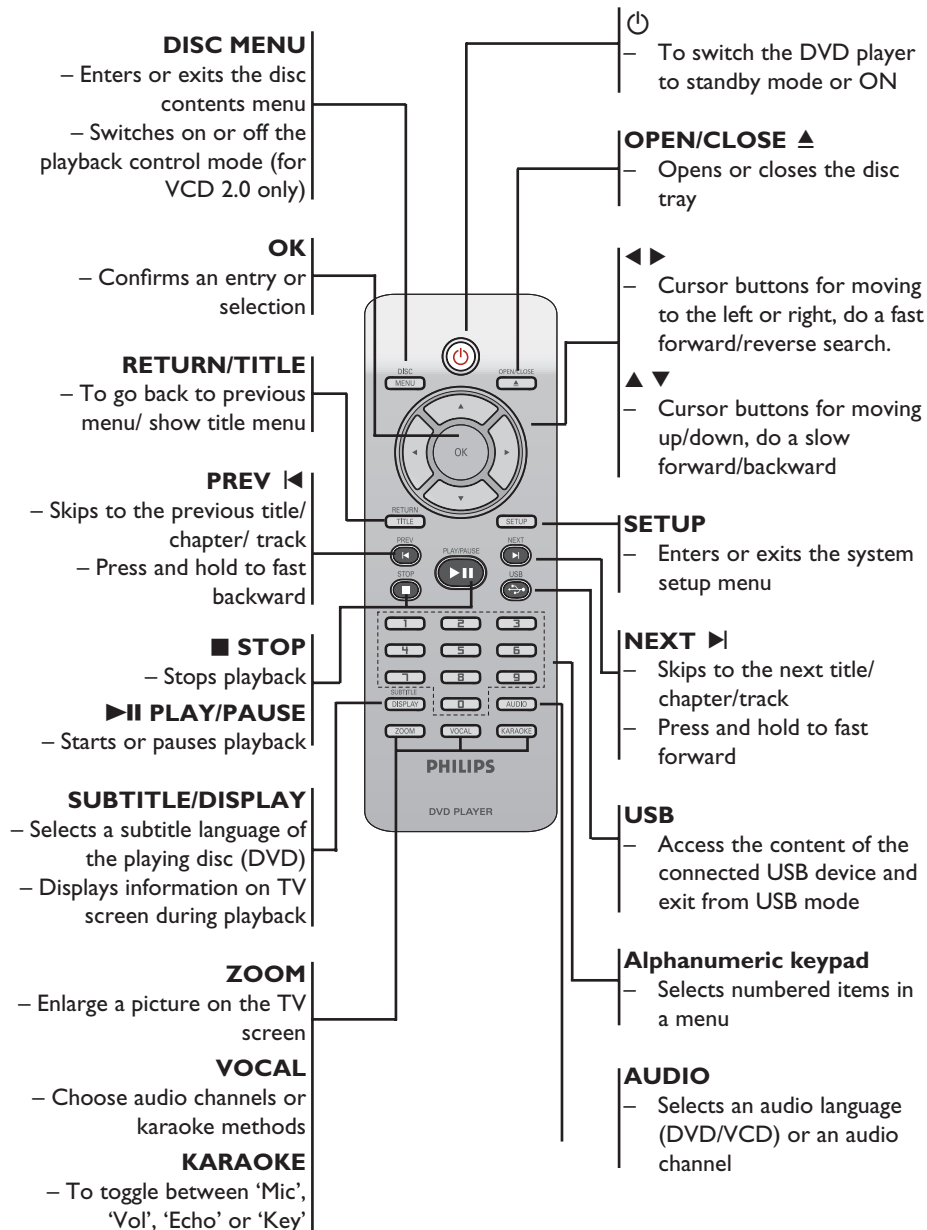

Getting Started

English

Step 1 : Inserting Batteries

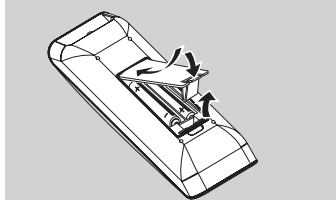

- 1 Open the battery compartment.
- 2 Insert two batteries type R03 or AAA, following the indications (+ -) inside the compartment.
- 3 Close the cover.

CAUTION!

- Remove batteries if they are exhausted or if the remote is not to be used for a long time.
- Do not use old and new or different types of batteries in combination.
- Batteries contain chemical substances, so they should be disposed of properly.

Using the remote control to operate the system

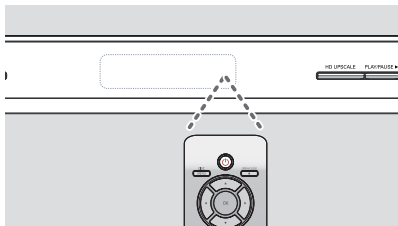

- 1 Aim the remote control directly at the remote sensor (IR) on the front panel.
- 2 Do not put any objects between the remote control and the DVD player while operating the DVD player.

Step 2 : Finding your viewing channel

- 1 Press **STANDBY-ON**  on the DVD player to turn it on.
- 2 Turn on the TV and set it to the correct video-in channel. You should see the blue DVD background screen.
 - Usually these channel are between the lowest and highest channels and may be called FRONT, A/V IN, VIDEO. See your TV's manual for more details.
 - Or, you may go to channel 1 on your TV, then press the Channel down button repeatedly until you see the Video In channel.
 - Or, the TV remote control may have a button or turn that chooses different video modes.
 - Or, set the TV to channel 3 or 4 if you are using an RF modulator.
- 3 If you are using external equipment, (such as audio system or receiver), turn it on and select the appropriate input source for the DVD player output. Refer to the equipment user's manual for detail.

Getting Started (continued)

Step 3 : Setting up Progressive Scan feature

(for Progressive Scan TV only)

The progressive scan displays twice the number of frames per second than interlaced scanning (ordinary normal TV system). With nearly double the number of lines, progressive scan offers higher picture resolution and quality.

Before you start...

- Ensure that you have connected this DVD player to a progressive scan TV using the YPbPr connection (see page 10).
- Ensure that you have completed the basic installation and setup.

- 1 Turn on your TV and set to interlace mode (refer to your TV user manual).
- 2 Press **STANDBY-ON** (⏻) on the remote control to turn on the DVD player.
- 3 Select the correct video-in channel.
→ The DVD background menu appears.
- 4 Press **SETUP**.
- 5 Press **▶** to select { **Video Setup Page** }.

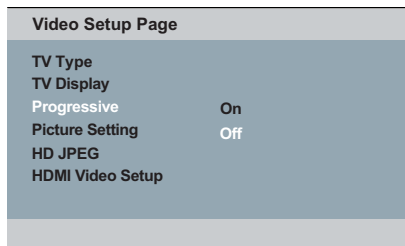

- 6 Press **▲ ▼** repeatedly to select { **Progressive** }, then press **▶**.

- 7 Select { **On** }, then press **OK** to confirm.
→ The menu will appear on the TV.

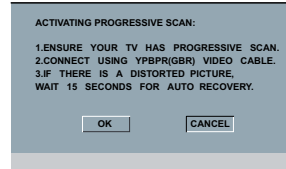

- 8 Press **◀** to highlight { **OK** } and press **OK** to confirm.
- 9 Turn on your TV progressive scan mode (refer to your TV user manual).
→ The menu will appear on the TV.

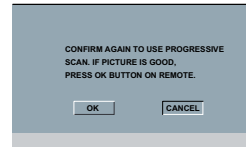

- 10 Press **◀** to highlight { **OK** } and press **OK** to confirm..
→ The setup is now completed and you can start enjoy the high quality picture.

To deactivate Progressive Scan manually:

- Wait for 15 seconds for the auto recovery.
- OR**
- 1 Press **OPEN/CLOSE** (⏻) on the DVD player to open the disc tray.
- 2 Press **numeric keypad '1'** on the remote control for few seconds.
→ The DVD background screen appears.

Tip:

– There are some progressive scan TVs and High-Definition TVs that are not fully compatible with this unit, resulting in the unnatural picture when playing back a DVD VIDEO disc in the progressive scan mode. In such a case, turn off the progressive scan feature on both the DVD player and your TV.

TIPS: The underlined option is the factory default setting.
Press **◀** to go back to previous menu item. Press **SETUP** to exit the menu item.

Getting Started (continued)

Step 4 : Selecting the matching color system

The color system of the DVD player, disc and TV should match in order for the disc to play. Before changing the TV system, determine the color system of your TV.

Video Setup Page	
TV Type	<u>NTSC</u>
TV Display	<u>PAL</u>
Progressive	<u>Multi</u>
Picture Setting	
HD JPEG	
HDMI Video Setup	

- 1 Press **SETUP**.
- 2 Press **▶** to select { **Video Setup Page** }.
- 3 Press **▲ ▼** repeatedly to select { **TV Type** }, then press **▶**.
- 4 Use **▲ ▼** to select one of the options below:

{ **PAL** }

Select this if the connected TV has the PAL color system. It will change the video signal of an NTSC disc and output it to PAL format.

{ **NTSC** }

Select this if the connected TV has the NTSC color system. It will change the video signal of a PAL disc and output it to NTSC format.

{ **Multi** }

Select this if the connected TV is compatible with both NTSC and PAL (multi-system). The output format will be in accordance with the video signal of the disc.

- 5 Select a setting and press **OK**.
→ Follow the instructions show on the TV to confirm the selection.

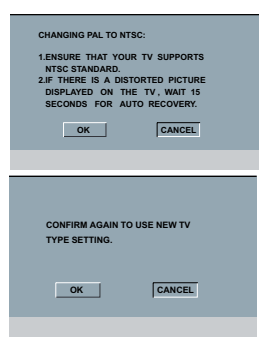

- 6 Press **◀** to highlight { **OK** } and press **OK** to confirm.

To reset to previous TV color system:

- Wait for 15 seconds for the auto recovery.
- OR**
- 1 Press **OPEN/CLOSE ▲** on the DVD player to open the disc tray.
- 2 Press **numeric keypad '3'** on the remote control for few seconds.
→ The DVD background menu appears.

Tips:

- Before changing the current TV colour setting, ensure that your TV supports the 'selected TV Type' system.
- If there is no proper picture on your TV, wait for 15 seconds for auto recovery.

TIPS: The underlined option is the factory default setting. Press **◀** to go back to previous menu item. Press **SETUP** to exit the menu item.

Getting Started (continued)

Step 5 : Setting the language

The language options are different depending on your country or region. It may not correspond to the illustrations shown on the user manual.

On-screen display (OSD) language

Select this to change the language of this DVD player screen display menu.

The menu language (on-screen display) for the system will remain as you set it.

General Setup Page	
Disc Lock	
<u>OSD Language</u>	ENGLISH
Sleep	ESPAÑOL
Lip Sync	PORTUGUÉS
Volume	
DivX(r) VOD Code	

- 1 Press **SETUP**.
- 2 Press **▲ ▼** to select { **OSD Language** }, then press **▶**.
- 3 Use **▲ ▼** to select a language and press **OK** to confirm.

Audio, Subtitle and Disc menu languages

You can choose your preferred language or sound track from audio, subtitles and disc menu languages. If the selected language is not available on the disc, the disc's default language will be used instead.

Preference Page	
Audio	English
Subtitle	Chinese
Disc Menu	French
Parental	Spanish
PBC	Portugues
Mp3 / Jpeg Nav	Polish
Password	Italian

- 1 Press **STOP** **■** twice to stop playback, (if any), then press **SETUP** on the remote control.
- 2 Press **▶** to select { **Preference Page** }.
- 3 Press **▲ ▼** to highlight one of the options below, then press **▶**.

{ **Audio** }

Select this to change disc sound track language.

{ **Subtitle** }

Select this to change the subtitle language.

{ **Disc Menu** }

Select this to change the language of the disc menu.

- 4 Use **▲ ▼** to select a language and press **OK** to confirm.

If the language you want is not in the list, then select { Others }, then use the numeric keypad (0-9) on the remote to enter the 4-digit language code 'XXXX' (see page 5 'Language Code') and press **OK.**

- 5 Repeat steps 3 - 4 for other language settings.

TIPS: The underlined option is the factory default setting.
Press **◀** to go back to previous menu item. Press **SETUP** to exit the menu item.

Playback from Disc

IMPORTANT!

- If the inhibit icon  appears on the TV screen when a button is pressed, it means the function is not available on the current disc or at the current time.
- DVD discs and players are designed with regional restrictions. Before playing a disc, make sure the disc is for the same zone as your player.

Playable discs

Using this DVD player, you can playback on the following discs:

DVD Video (Digital Versatile Disc)



DVD±RW (DVD Rewritable) Audio/Video format or MP3/WMA/JPEG/DivX® files.



DVD±R (DVD Recordable) Audio/Video format or MP3/WMA/JPEG/DivX® files.



CD-R (CD-Recordable) Audio/Video format or MP3/WMA/JPEG/DivX® files.



CD-RW (CD-Rewritable) Audio/Video format or MP3/WMA/JPEG/DivX® files.



Audio CD (Compact Disc Digital Audio)



Video CD
(Formats 1.0, 1.1, 2.0)



Super Video CD



MP3-Disc



DivX® Disc
(DivX® 3.11, 4.x, 5.x, 6.0 and DivX® Ultra)



Supported formats

MP3/WMA tracks

- The file extensions has to be '.mp3', '.wma'
- JPEG/ISO format
- Maximum 14 characters display.
- Supported bit-rate:
 - 32 – 320 kbps (MP3)
 - 32 – 192 kbps (WMA)

JPEG pictures

- The file extensions has to be '.JPG' and not '.JPEG.'
- JPEG/ISO format
- It can only display DCF-standard still pictures or JPEG pictures such as TIFF.

DivX® movies

- The file extensions has to be '.AVI,' '.MPG,' or '.MP4.'
- DivX® 3.11, 4.x, 5.x, 6.0 and DivX® Ultra
- Q-pel accurate motion compensation
- Global Motion Compensation (GMC) playback.







Tips:

- Maximum 100 sessions for CD and 10 multi border for DVD are supported.
- For DVD-R and DVD-RW multi border, only finalised disc are supported.
- For DVD+R and DVD+RW multi border both finalised and unfinalised disc are NOT supported.

TIPS: Some discs cannot be played on this DVD player due to the configuration and characteristics of the disc, or due to the condition of recording and authoring software that was used.

Playback Features

Starting disc playback

- 1 Turn on the TV to the correct program number for the DVD player (e.g. 'EXT', '0', 'AV').
- 2 Press **STANDBY-ON**  to turn on the DVD player.
 - You can also press **OPEN/CLOSE**  button to turn on the DVD player and the will be followed by disc tray open.
- 3 Press **OPEN/CLOSE**  on the front of the DVD player.
 - You can also hold down the **STOP**  button on the remote control to open and close the disc tray.
- 4 Place a disc into the disc tray with the label facing up, then press **OPEN/CLOSE** .
 - For double-sided discs, load the side which you want to play facing up.
- 5 Playback may start automatically. If not, press **PLAY/PAUSE** .
 - If a disc menu appears on the TV, see page 25 'Using the Disc Menu'.
 - If the child lock was activated for the inserted disc, you have to enter your six-digit password (see page 48).
 - For more playback features, see pages 24~34.

Tips:



- Do not overturn the DVD player while disc loading, playing or ejecting.
- Do not close the disc tray manually even if the power switched off.

TIPS: The operating features described here might not be possible for certain discs. Always refer to the instructions supplied with the discs.



Basic playback controls

Unless otherwise stated, all operations described are based on Remote Control use.

Pausing playback

- 1 During playback, press **PLAY/PAUSE**  to pause playback and display a still picture.
 - Sound will be muted.
- 2 To resume normal playback, press **PLAY/PAUSE**  again.

Selecting title/chapter/track

- During playback, press **PREV**  to go to the beginning of the current chapter/track, press **PREV**  again to go to the previous title/chapter/track.
- Press **NEXT**  to go to the next chapter/track.
- Press **DISPLAY** to display the disc information text line for title/chapter/track (example - 00/08).
- Use **alphanumeric keypad (0-9)** to enter valid title/chapter/track number.
 - The playback skips to the selected title/chapter/track.

Stopping playback

- Press **STOP** .

Tips:

- Screen saver will start automatically if the disc playback is stopped/paused for about 5 minutes.
- The player will automatically switch to Power Standby mode if you do not press any buttons for about 15 minutes after the disc has stopped playing.

Playback Features (continued)

Operations for video playback

Using the Disc Menu

Depending on the disc, a menu may appear on the TV screen once you load in the disc.

To select a playback feature or item

- Use ▲ ▼ ◀ ▶ keys or **numeric keypad (0-9)** on the remote, then press **OK** to start playback.

To access or remove the menu

- Press **DISC MENU** on the remote.

Zooming in

This function allows you to enlarge the picture on the TV screen and to pan through the enlarged picture.

- 1 During playback, press **ZOOM** repeatedly to display the picture with different scales.
 - Use ▲ ▼ ◀ ▶ keys to pan through the enlarged picture.
 - Playback will continue.
- 2 Press **ZOOM** repeatedly to return to the original size.

Resuming playback from the last stopped point

Resume playback of the last 5 discs is possible, even if the disc was ejected (open) or standby. Auto resume is active for DVD, VCD, SVCD, CD types of discs.

- Load one of the last 5 discs.
 - 'Play from start, press [PREV]' appears during playback for first 10 seconds.

- During the message appears on the TV screen, press **PREV** to start playback from the beginning.
 - Playback restarts from the first title (DVD) or the beginning of the title/track (VCD/CDDA/SVCD).

To cancel resume mode

- In stop mode, press **STOP** ■ again.

Tip:

- To remove the message from the TV screen, press **DISPLAY**.

Slow Motion

You can slow forward or slow reverse a disc during playback and select a different speed.

For DivX®, DVD, VCD, SVCD

- 1 Press ▲ ▼ during playback to select the required speed: 1/2, 1/4, 1/8 or 1/16 (forward [DivX®, DVD, VCD, SVCD] or backward [DVD]).
 - Sound will be muted.
- 2 To return to normal speed, press **PLAY/PAUSE** ►||.

Forward / Reverse Searching

You can fast forward or fast reverse a disc during playback and select a desired search speed.

For DivX®, DVD, VCD, SVCD, CD, MP3, WMA

- 1 Press ◀ ▶ directly or press ◀ ▶ for 2 seconds during playback to select the required speed: 2X, 4X, 8X, 16X or 32X (backward or forward).
 - Sound will be muted (DVD/VCD/SVCD/DivX®) or intermittent (MP3/WMA/CD).
- 2 To return to normal speed, press **PLAY/PAUSE** ►||.

TIPS: The operating features described here might not be possible for certain discs. Always refer to the instructions supplied with the discs.

Playback Features (continued)

Viewing the disc playback information

Using the OSD menu

OSD menu shows the disc playback information (for example, title or chapter number, elapsed playing time, audio/subtitle language), a number of operations can be done without interrupting disc playback.

- For DVD disc playback, pressing **SUBTITLE/DISPLAY** will toggle between Subtitle and OSD menu.
- For VCD disc playback, pressing **SUBTITLE/DISPLAY** will display OSD menu.
 - The available disc information appears on the TV screen with the following sequence.

MENU		
Title	01/01	
Chapter	01/01	
Audio	5.1CH	Others
Subtitle	Off	
Bitrate 61  Total Elapsed 0:48:59		

(DVD)

MENU		
Track	01/21	
Disc Time	1:12:32	
Track Time	0:02:29	
Repeat AB	Off	
Bitrate 61  Total Elapsed 0:48:59		

(VCD)

Title/Chapter/Track selection

- 1 Press ▲ ▼ to select {Title} / {Chapter} or {Track}, then press ► to access.
- 2 Use the **alphanumeric keypad 0-9** to input a valid number (e.g. 04/05).
 - The playback skips to the chosen title/chapter/track.

Time Search

- 1 Press ▲ ▼ to select {TT Time} / {CH Time} / {Disc Time} or {Track Time}, then press ► to access.
- 2 Use the **alphanumeric keypad 0-9** to input the valid time (such as 0:34:27).
 - The playback skips to the chosen time.

Audio / Subtitle

- 1 Press ▲ ▼ to select {Audio} or {Subtitle}, then press ► to access.
- 2 Press ▲ ▼ to select one language.
- 3 Press **OK** to confirm.
 - The current audio or subtitle language will be changed to the selected language.

Angle

- 1 Press ▲ ▼ to select {Angle}, then press ► to access.
- 2 Use the **alphanumeric keypad 0-9** to input a valid number.
 - Playback will go to the selected angle.

TIPS: The operating features described here might not be possible for certain discs. Always refer to the instructions supplied with the discs.

Playback Features (continued)

Time Display

- Press ▲ ▼ to select {Time Disp.} (Time Display), then press ► to access.
 - Depending on the disc in the DVD player, the following display types appear on the TV screen.

For DVD

- TT Elapsed (elapsed playing time of current Title)
- TT Remain (remaining playing time of current Title)
- CH Elapsed (elapsed playing time of current Chapter)
- CH Remain (remaining playing time of current Chapter)

For VCD/SVCD

- Total Elapsed (elapsed playing time of current Disc)
- Total Remain (remaining playing time of current Disc)
- Single Elapsed (elapsed playing time of current Track)
- Single Remain (remaining playing time of current Track)

Repeat

- 1 Press ▲ ▼ to select {Repeat}, then press ► to access.
 - Repeat menu appears on the TV screen.
- 2 Press ▲ ▼ to select one of the following repeat mode.

For DVD

- Chapter (currently playing chapter)
- Title (currently playing title)
- All (entire disc)
- Off (cancel)

For Video CD

- Track (currently playing track)
- All (entire disc)
- Off (cancel)

Repeat A-B

- 1 Press ▲ ▼ to select {Repeat A-B}.
- 2 Press **OK** to mark the starting point 'A'.
- 3 Press **OK** again to mark the ending point 'B'.
 - The playback from point 'A' and 'B' is repeat.
- 4 Press **OK** the third time to exit.

TIPS: The operating features described here might not be possible for certain discs. Always refer to the instructions supplied with the discs.

Playback Features (continued)

Preview

The preview function allows you to reduce the picture of 6 tracks enough to display in a full screen.

- Press ▲ ▼ to select {Preview}, then press ► to access.
→ The preview menu appears on the TV screen.

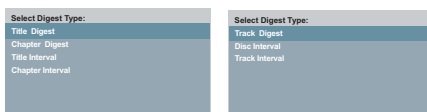

(DVD example)

(Video CD example)

- Press ▲ ▼ to select the preview type, then press **OK**.
→ The picture of each segment will appear on the TV screen.

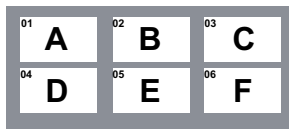

(example of 6 thumbnail pictures display for DVD chapter digest preview type)

- Press ▲ ▼ ◀ ▶ to select a track or input your selected track number using the alphanumeric keypad (0-9), then press **OK**.
→ Playback will start automatically on the selected track.

Viewing Audio CD playback information

This function displays audio disc information on the TV screen during playback.

- During playback, press **SUBTITLE/DISPLAY**.
→ A list of available disc information appears on the TV screen.

Disc Go To / Track Go To / Track Selection

- Press **SUBTITLE/DISPLAY** repeatedly to select an option.
- Enter minutes and seconds from left to right in the time edit box using alphanumeric keypad 0-9.
→ Playback will change to the chosen time or to the selected track.

For Audio CD

- Disc Go To: XX/XX (enable to select any part within the disc)
- Track Go To: XX/XX (enable to select any part within the current track)
- Select Track: XX/TT (enable to select any track within the disc)

Repeat

- Press **SUBTITLE/DISPLAY** repeatedly to select {Off}.
- Press ◀ ▶ to switch between repeat mode.

For Audio CD

- Track (currently playing track)
- All (entire disc)
- Off (cancel)

TIPS: The operating features described here might not be possible for certain discs. Always refer to the instructions supplied with the discs.

Playback Features (continued)

Special DVD Features

Playing a Title

- 1 Press **DISC MENU**.
→ The disc title menu appears on the TV screen.
- 2 Use **▲ ▼ ◀ ▶** keys or **alphanumeric keypad 0-9** to select a play option.
- 3 Press **OK** key to confirm.

Changing the Audio Language

For DVD

- Press **AUDIO** repeatedly to select different audio languages.

Changing the Audio Channel For VCD

- Press **AUDIO** to select the available audio channels provided by the disc (MONO LEFT, MONO RIGHT, MIX-MONO, STEREO).

Subtitles

- Press **SUBTITLE/DISPLAY** repeatedly to toggle between subtitle and OSD menu.
- When subtitle menu is selected, press **◀ ▶** to select different subtitle languages.

Special VCD and SVCD Feature

Playback Control (PBC)

For VCD with Playback Control (PBC) feature (version 2.0 only)

- Press **DISC MENU** to toggle between 'PBC ON' and 'PBC OFF'.
→ If you select 'PBC ON', the disc menu (if available) will appear on the TV.
→ Use the **PREV ◀ / NEXT ▶** to go to previous/next page or use the **alphanumeric keypad 0-9** to select a play option.
- During playback, pressing **RETURN/TITLE** will return to the menu screen (if PBC is on).

If you want to skip the index menu and playback directly from the beginning,

- Press **DISC MENU** key on the remote control to turn to PBC off.

TIPS: The operating features described here might not be possible for certain discs. Always refer to the instructions supplied with the discs.

Playback Features (continued)

Playing a DivX® disc

This DVD player supports the DivX® movie playback that you download from your computer onto a CD-R/RW or DVD±R/RW (see page 37 for more information).

- 1 Load a DivX® disc.
→ The data disc menu appears on the TV screen.
 - 2 Press ▲ ▼ to select the folder and press **OK** to open the folder.
 - 3 Press ▲ ▼ to select a track/file.
 - 4 Press **OK** to confirm.
- Press **SUBTITLE/DISPLAY** on the remote control will toggle between subtitle menu, {Single Elapsed}, {Single Remain} or no time display during playback.
 - If multilingual subtitles are embedded on the DivX® disc (with subtitle menu selected), press ◀ ▶ to select different subtitle languages.
 - If multi audio are embedded on the DivX® disc, pressing **AUDIO** repeatedly to select different audio language during playback.

Tips:

- Subtitle files with the following filename extensions (.srt, .smi, .sub, .ssa, .txt) are supported but do not appear on the file navigation menu.
- The subtitle filename (.sub) have to be saved under the same filename as the movie (.avi) in the same folder.
[For example, Folder A: abc.avi and abc.sub]

Advance features of the DivX® Ultra

- **XSUB™ subtitles** let you author movies with multiple language subtitle sets.
- **Interactive video menus** offer unprecedented convenience and control so you can quickly navigate between various scenes or bonus features and select from audio track and subtitle options.
- **Alternate audio tracks** enable audio tracks in multiple language versions or separate audio tracks for specific speaker configurations.
- **Chapter points** provide flexibility, allowing you to jump straight to the scene, you want to watch from anywhere with the video.

TIPS: The operating features described here might not be possible for certain discs. Always refer to the instructions supplied with the discs.

Playback Features (continued)

USB mass storage device

When connecting a USB mass storage device to the DVD player, you can enjoy the device's stored music through the DVD player.

- Compatible USB mass storage device:
 - USB flash memory (USB 2.0 or USB 1.1)
 - USB flash players (USB 2.0 or USB 1.1)
 - memory cards (requires an additional card reader to work with this DVD player).
- Supported formats:
 - USB or memory file format FAT16, FAT 32 (sector size: 2K bytes)
- The DVD player will not play or support the following:
 - Empty albums: an empty album is an album that does not contain MP3/WMA files and will not be shown in the display.
 - Non-supported file formats are skipped. This means that e.g.: Word document '.doc' or MP3 files with extension '.dlf'.
 - AAC, PCM and WAV audio files.
 - DRM protected WMA files.
 - WMA files in Lossless format.

Compatibility of USB device

- Not all Portable audio/video players and Digital cameras are supported.
- If a non-supported device is connected, the TV screen will display 'Device Not Supported'.
- The USB port can supports the playback of JPEG/MP3/WMA files and are able to read '.avi', '.mp4' and '.mpg' container.
- Copy protected contents are not playable.

English

TIPS: The operating features described here might not be possible for certain discs. Always refer to the instructions supplied with the discs.

Playback Features (continued)

Playing from USB flash drive or USB memory card reader

You can play or view the data files (JPEG, MP3 or WMA) in the USB flash drive or USB memory card reader through this DVD player.

However, editing and copying the data files are not possible.

- ① During disc playback, insert a USB mass storage device into the USB port (see page 14).
 - 'Press USB key to select device' will appear on the TV screen.
- ② Press **USB** on the remote control to access the data in the drive.
 - A file menu that contains all supported files will appear on the TV screen.
 - The word **USB1** will be highlighted on the menu (only one USB mass storage device is connected).

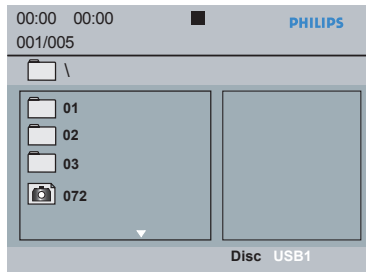

- ③ Press **▲ ▼** to select a file, then press **OK** to confirm.
- ④ Press **USB** on the remote control to exit from the menu and switch to disc playback.

- The DVD player will access the USB mass storage device directly when a USB device is plugged in and if there is no disc playing.

Tip:

– A total of 300 folders and maximum of 648 titles can be supported.

Transfer of music files from PC to a USB mass storage device

- By dragging and dropping music files, you can easily transfer your favorite music from PC to a USB mass storage device.
- For flash player, you can also use its music management software for the music transfer.
- However, those WMA files may not be playable for compatibility reasons.

TIPS: The operating features described here might not be possible for certain discs. Always refer to the instructions supplied with the discs.

Playback Features (continued)

Playing MP3/WMA/JPEG Picture CD

This DVD player can playback MP3, WMA, JPEG and Picture CD files on a personally recorded CD-R/RW disc, commercial CD or USB device.

IMPORTANT!

You have to turn on your TV and set to the correct Video In channel. (See page 19 'Finding your viewing channel').

General Operation

- 1 Load a disc or plug in an USB device.
 - The disc reading time may exceed 30 seconds due to the complexity of the directory/file configuration.
 - The data disc menu appears on the TV screen.

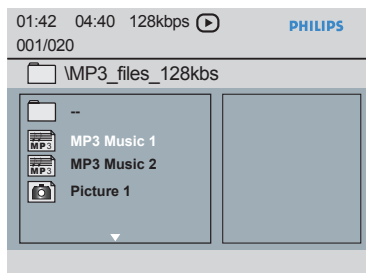

- 2 Press **PREV** ◀ / **NEXT** ▶ to go to previous / next page of the menu.
- 3 Press ▲ ▼ to select the folder and press **OK** to open the folder.
- 4 Press ▲ ▼ to select a track/file.
 - If a jpeg file is selected, a preview will appear on the TV screen.
 - If a MP3/WMA file is selected, ID3 (MP3 - including at least title, singer and album) and Meta data (WMA - including title, artist, copyright and comment) information appears on the TV screen.

- 5 Press **OK** to confirm.

Tip:

– If the playing file is not selected, the ID3/ Meta information will disappear.

Playback selection

During playback, you can;

- Press **PREV** ◀ / **NEXT** ▶ to select the previous/next track/file in the current folder.
- Press **PLAY/PAUSE** ▶|| repeatedly to pause/resume playback.

Repeat

- Press **SUBTITLE/DISPLAY** to switch between the following repeat mode.

For MP3/WMA

- Repeat One (currently playing file)
- Repeat Folder (all files in selected folder)
- Folder (playing all files)
- Single (currently playing file once)

For JPEG, DivX®

In STOP mode,

- Repeat One (currently playing file)
- Repeat Folder (all files in selected folder)
- Folder (playing all files)
- Single (currently playing file once)

In PLAY mode,

For JPEG,

Press **SUBTITLE/DISPLAY** during playback, 12 thumbnail pictures appears on the TV screen.

TIPS: The operating features described here might not be possible for certain discs. Always refer to the instructions supplied with the discs.

Playback Features (continued)

Playback with multi-angles (JPEG)

- During playback, press ▲ ▼ ◀ ▶ to rotate the picture on the TV screen.
 - ▲: flip the picture vertically by 180°
 - ▼: flip the picture horizontally by 180°
 - ◀: rotate the picture anti-clockwise by 90°
 - ▶: rotate the picture clockwise by 90°

Tips:

- It may not be possible to play certain MP3/JPEG disc due to the configuration and characteristics of the disc or condition of the recording.
- It is normal to experience an occasional 'skip' while listening to your MP3 disc.
- For multi-session discs with different formats, only the first session will be available.

Preview Function (JPEG)

This function shows the content of the current folder or the whole disc.

- 1 Press **SUBTITLE/DISPLAY** during playback.
 - 12 thumbnail pictures will appear on the TV screen.



- 2 Press **PREV** ◀ / **NEXT** ▶ to display the other pictures on the previous / next page.
- 3 Press ▲ ▼ ◀ ▶ to select one of the picture and press **OK** to start playback.
- 4 Press **DISC MENU** to return to Picture CD menu.

Zoom picture (JPEG)

- During playback, press **ZOOM** repeatedly to display the picture with different scales.
- Use ▲ ▼ ◀ ▶ to view the zoomed picture.

Playing MP3/WMA music and JPEG picture simultaneously

- 1 Load a disc that contains MP3/WMA music and JPEG picture files.
 - The disc menu appears on the TV screen.
- 2 Select an MP3/WMA track.
- 3 During MP3/WMA music playback, select a picture file on the TV screen and press **OK**.
 - A slide show will start at the same time as the MP3/WMA audio file is playing.
- 4 To quit simultaneous playback, press **STOP** ■ to stop the slide show.
- 5 Press **STOP** ■ again to stop the audio.

Tips:

- Some files on Kodak or JPEG disc may be distorted during playback due to the configuration and characteristics of the disc.
- During simultaneous playback, fast forward / reverse or slow forward is not available.

TIPS: The operating features described here might not be possible for certain discs. Always refer to the instructions supplied with the discs.

Karaoke Operations

Playing Karaoke discs

IMPORTANT!

You have to turn on your TV and set to the correct Video In channel. (See page 19 'Finding your viewing channel').

General Operation

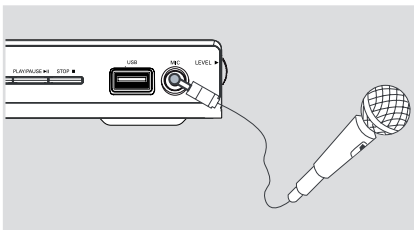

- 1 Connect a microphone (not supplied) to **MIC** on the front panel of the DVD player.
- 2 Load a karaoke disc.
- 3 Press **KARAOKE** repeatedly to access Karaoke menu MIC On/Off.
 - 'MIC On/Off' appears on the TV screen.
 - Press ◀▶ to turn 'On' or 'Off' the microphone.
- 4 Adjust the microphone volume up or down using **MIC LEVEL** button on the side panel of the DVD player.

Tip:

– Before connecting the microphone, set the microphone volume to the minimum level to prevent howling.

Vocal

- You can fade out the original vocal from a karaoke disc.
- Press **VOCAL** repeatedly to choose different audio modes.

Tip:

– This function and on-screen display depends on the availability of the disc.

Karaoke menu

- Press **KARAOKE** repeatedly to toggle between 'MIC', 'Vol', 'Echo' or 'Key'.
- 1 When 'MIC' is selected, press ◀▶ to set 'Mic On/Off'.
 - 2 When 'Vol' is selected, press ◀▶ to adjust the vocal value between 0 and 20.
 - 3 When 'Echo' is selected, press ◀▶ to adjust the echo level between 0 and 20.
 - 4 When 'Key' is selected, press ◀▶ to adjust the pitch value between -16 and 16.

This function allows you to adjust the key tone level to match your vocal.

DVD Menu Options

This DVD Player setup is carried out via the TV, enabling you to customize the DVD player to suit your particular requirement.

Using the General setup menu

- 1 Press **SETUP** on the remote control.
→ The system setup menu appears.

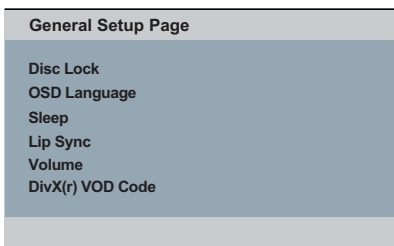

- 2 Press ◀ ▶ to select { **General Setup Page** }.
- 3 Press ▲ ▼ to select an item, then press ▶ to access.
Example: { **OSD Language** }
→ The options for the selected item appears.
→ If the selection in the menu is greyed out, that means the feature is not available or not possible to change at the current state.
- 4 Use ▲ ▼ to select a setting and press **OK** to confirm.
Example: { **English** }
→ The setting is selected and setup is complete.
- 5 To exit, press **SETUP**.

Locking/Unlocking the disc for viewing

Not all discs are rated or coded by the disc maker. You can prevent a specific disc from playing by locking the disc. Up to 20 discs can be locked.

- 1 In 'General Setup Page', press ▲ ▼ to select { **Disc Lock** }, then press ▶.

{ **Lock** }

Select this to block the playback of the current disc. Subsequent access to a locked disc requires six-digit password. The default password is '136900' (see page 48 'Changing the password').

{ **Unlock** }

Select this to unlock the disc and allow future playback.

- 2 Use ▲ ▼ to select a setting and press **OK** to confirm.

OSD Language

This menu contains various language options for the language displayed on the screen. For details, see page 22.

TIPS: The underlined option is the factory default setting.
Press ◀ to go back to previous menu item. Press **SETUP** to exit the menu item.

DVD Menu Options (continued)

Sleep

Sleep function allows you to turn off the DVD player automatically after a preset time.

- 1 In 'General Setup Page', press ▲ ▼ to select { **Sleep** }, then press ►.

{ 15 Mins }

Turn off the DVD player after 15 minutes.

{ 30 Mins }

Turn off the DVD player after 45 minutes.

{ 45 Mins }

Turn off the DVD player after 45 minutes.

{ 60 Mins }

Turn off the DVD player after 60 minutes.

{ Off }

Turn off the sleep function.

- 2 Use ▲ ▼ to select a setting and press **OK** to confirm.

Lip Sync

This allows you to adjust the audio delay (ms) with respect to the video output for the lip synchronisation.

- 1 In 'General Setup Page', press ▲ ▼ to select { **Lip Sync** }, then press ►.
→ Use ◀ ▶ to adjust the following options; {00ms} – {200ms}
→ The default setting is {00ms}
- 2 Press **OK** to confirm.

Volume

This option allows you to adjust the volume level between 0 to 20.

- 1 In 'General Setup Page', press ▲ ▼ to select { **Volume** }, then press ►.
→ 'Volume' control page appears on the TV screen.
- 2 Press ◀ ▶ to adjust the volume level between 0 to 20, the default setting is 20.

DivX® VOD registration code

DivX® VOD registration code allows you to rent and purchase movies using the DivX® service from the internet. For more information, visit website; <http://vod.divx.com>

- 1 In 'General Setup Page', press ▲ ▼ to select { **DivX(R) VOD Code** }, then press ►.
→ The registration code will appear.
- 2 Press **OK** to exit.
- 3 Use the registration code to rent or purchase the movies from DivX® VOD service at <http://vod.divx.com>.
→ Follow the instructions and download the movie from your computer onto a CD-R/DVD±R(W) for playback on this DVD player.

Tips:

- All the downloaded movies from DivX® Registration can only be played back on this DVD player.
- Time search feature is not available during DivX® movie playback.

TIPS: The underlined option is the factory default setting.
Press ◀ to go back to previous menu item. Press **SETUP** to exit the menu item.

DVD Menu Options (continued)

Using the Audio setup menu

- 1 Press **SETUP** on the remote control.
→ The system setup menu appears.

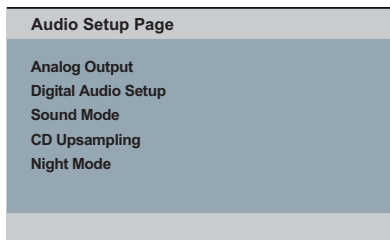

- 2 Press ◀ ▶ to select { **Audio Setup Page** }.
- 3 Press ▲ ▼ to select an item, then press ▶ to access.
Example: { **Night Mode** }
→ The options for the selected item appears.
→ If the selection in the menu is greyed out, that means the feature is not available or not possible to change at the current state.
- 4 Use ▲ ▼ to select a setting and press **OK** to confirm.
Example: { **On** }
→ The setting is selected and setup is complete.
- 5 To exit, press **SETUP**.

Analog Output

This option allows you to set the stereo analog output of your DVD player.

- 1 In 'Audio Setup Page', press ▲ ▼ to select { **Analog Output** }, then press ▶.

{ Stereo }

Select this option when output delivers sound from only the two front speakers.

{ LT/RT }

Select this option if your DVD player is connected to a Dolby Pro Logic decoder.

{ V SURR }

Allows the DVD player to use virtual surround sound effects.

- 2 Use ▲ ▼ to select a setting and press **OK** to confirm.

Digital Audio Setup

The options included in Digital Audio Setup are: {Digital Output}, {LPCM Output} and {HDMI Audio Setup}.

- 1 In 'Audio Setup Page', press ▲ ▼ to select { **Digital Audio Setup** }, then press ▶.
- 2 Press ▲ ▼ to select an item, then press ▶ to access.
- 3 Use ▲ ▼ to select a setting and press **OK** to confirm.

TIPS: The underlined option is the factory default setting.
Press ◀ to go back to previous menu item. Press **SETUP** to exit the menu item.

DVD Menu Options (continued)

Digital Output

Set the Digital Output according to your optional audio equipment connection.

{ All }

Select this if the connected device has a built-in multichannel decoder that supports one of the multichannel audio format (Dolby Digital, MPEG-2).

{ PCM Only }

Select this if the connected device is not capable of decoding multichannel audio. The DVD player will convert the Dolby Digital and MPEG-2 multichannel signals to PCM (Pulse Code Modulation).

{ Off }

To deactivate the digital audio output. For example, if you use the AUDIO OUT sockets to connect to a TV or stereo system.

LPCM Output

If you connect the DVD player to a PCM compatible receiver via the digital terminals, such as coaxial or optical etc, you may need to adjust 'LPCM Output'.

{ 48K }

Playback a disc recorded at the sampling rate of 48kHz.

{ 96K }

Playback a disc recorded at the sampling rate of 96kHz. This rate can only be achieved in Stereo-Classic (Flat) mode.

Tip:

– Discs are recorded at a certain sampling rate. The higher the sampling rate, the better sound quality. LPCM Output can be selected only when PCM Only is activated.

HDMI Audio Setup

This function allows you to set the digital audio to output via HDMI cable.

{ On }

To enable the HDMI digital audio to output via HDMI cable.

{ Off }

To disable the HDMI digital audio to output via HDMI cable.

Tips:

- {Digital Output} and {LPCM Output} are only applicable when {HDMI Audio Setup} is set to {Off}.
- If {HDMI Audio Setup} is set to {Off}, no sound could be heard through HDMI connection.
- If {HDMI Audio Setup} is set to {On}, it is possible to hear PCM audio file via coaxial connection.

TIPS: The underlined option is the factory default setting.
Press ◀ to go back to previous menu item. Press **SETUP** to exit the menu item.

DVD Menu Options (continued)

Sound Mode

The options included in Sound Mode Setup are {3D}, {Movie Mode}, {Music Mode}.

- 1 In 'Audio Setup Page', press ▲ ▼ to select { **Sound Mode** }, then press ►.
- 2 Press ▲ ▼ to select an item, then press ► to access.
- 3 Use ▲ ▼ to select a setting and press **OK** to confirm.

3D

This function provides a virtual surround sound experience using just two speakers.

→ { Off } – { **Living Room** } – { **Hall** }
– { **Arena** } – { **Church** }

Movie Mode

Provides various Movie sound effects.

→ { Off } – { **Sci-Fic** } – { **Action** } –
{ **Drama** } – { **Concert** }

Music Mode

Select a Sound Mode that matches the type of music you are playing. These preset Sound Modes adjust the frequency bands of the audio to enhance your favorite music.

Provides various Music sound effects.

→ { Off } – { **Digital** } – { **Rock** } –
{ **Classic** } – { **Jazz** }

CD Upsampling

This feature allows you to convert your music CD to a higher sampling rate using sophisticated digital signal processing for better sound quality.

- 1 In 'Audio Setup Page', press ▲ ▼ to select { **CD Upsampling** }, then press ►.

{ Off }

Select this to disable CD Upsampling.

{ **88.2 kHz (x2)** }

Select this to convert the sampling rate of the CDs twice higher than the original.

{ **176.4 kHz (x4)** }

Select this to convert the sampling rate of the CDs four times higher than the original.

- 2 Use ▲ ▼ to select a setting and press **OK** to confirm.

Tip:

– CD Upsampling feature is only applicable to stereo output setting when playing CD disc.

Night Mode - turning on/off

This mode optimizes playback of sound at low volume. High volume outputs will be softened and low volume outputs are brought upward to an audible level.

- 1 In 'Audio Setup Page', press ▲ ▼ to select { **Night Mode** }, then press ►.

{ On }

Select this to set low volume output. This feature is only available for movie discs with Dolby Digital mode.

{ Off }

Turns off night mode feature. Select this to enjoy the surround sound with its full dynamic range.

- 2 Use ▲ ▼ to select a setting and press **OK** to confirm.

TIPS: The underlined option is the factory default setting.
Press ◀ to go back to previous menu item. Press **SETUP** to exit the menu item.

DVD Menu Options (continued)

Using the Video setup menu

- 1 Press **SETUP** on the remote control.
→ The system setup menu appears.

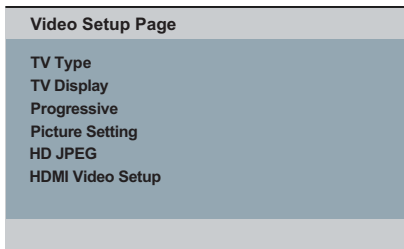

- 2 Press ◀ ▶ to select { **Video Setup Page** }.
- 3 Press ▲ ▼ to select an item, then press ▶ to access.
Example: { **TV Type** }
→ The options for the selected item appears.
→ If the selection in the menu is greyed out, that means the feature is not available or not possible to change at the current state.
- 4 Use ▲ ▼ to select a setting and press **OK** to confirm.
Example: { **NTSC** }
→ The setting is selected and setup is complete.
- 5 To exit, press **SETUP**.

TV Type

This menu contains the options for selecting the color system that matches the connected TV. For details, see page 21.

Setting the TV Display

The picture shape can be adjusted to fit your TV and the format must be available on the playback disc. Otherwise, the TV display will not affect the picture during playback.

- 1 In 'Video Setup Page', press ▲ ▼ to select { **TV Display** }, then press ▶.

{ **4:3 Pan Scan** }

Select this if you have a normal TV and want both sides of the picture to be trimmed or formatted on the TV screen.

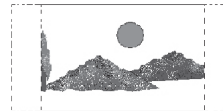

{ **4:3 Letter Box** }

Select this if you have a normal TV. A 'wide-screen' display with black bars on the top and bottom will be displayed on the TV screen.



{ **16:9** }

Select this for wide-screen TV (frame ratio 16:9).



- 2 Use ▲ ▼ to select a setting and press **OK** to confirm.

TIPS: The underlined option is the factory default setting.
Press ◀ to go back to previous menu item. Press **SETUP** to exit the menu item.

DVD Menu Options (continued)

Progressive

In the progressive scan mode, you can enjoy the high quality picture with less flickers. It only works when you have connected the DVD player's YPbPr jacks to your TV that supports the progressive video input. Otherwise, a distorted picture will appear on the TV. For proper progressive scan set up, see page 20.

- ① In 'Video Setup Page', press ▲ ▼ to select { **Progressive** }, then press ►.
 - { **Off** }
 - To disable Progressive Scan function.
 - { **On** }
 - To enable Progressive Scan function.
- ② Use ▲ ▼ to select a setting and press **OK** to confirm.
 - Follow the instructions shown on the TV screen to confirm the selection (if any).
 - If a distorted picture appears on the TV screen, wait for 15 seconds for auto recovery.

Picture Setting

This DVD player provides four predefined sets of picture color settings.

- ① In 'Video Setup Page', press ▲ ▼ to select { **Picture Setting** }, then press ►.
 - { **Standard** }
 - Select this for a preset standard picture setting.
 - { **Vivid** }
 - Select this to make the picture brighter.
 - { **Cool** }
 - Select this to make the picture softer.
 - { **Personal** }
 - Select this to personalize your picture color by adjusting the brightness, contrast, sharpness and color (saturation).
- ② Use ▲ ▼ to select a setting and press **OK** to confirm.
- ③ If you select {PERSONAL}, then proceed to steps ④~⑦.
 - The 'personal picture setup' menu appears.

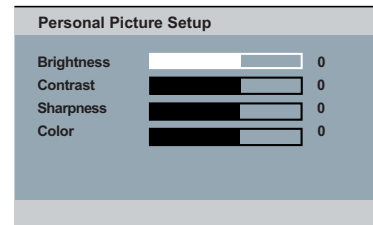

TIPS: The underlined option is the factory default setting.
Press ◀ to go back to previous menu item. Press **SETUP** to exit the menu item.

DVD Menu Options (continued)

- 4 Press ▲ ▼ to highlight one of the following options.

BRIGHTNESS

Increase the value to brighten the picture or vice versa. Choose zero (0) for average setting.

CONTRAST

Increase the value to sharpen the picture or vice versa. Choose zero (0) to balance the contrast.

SHARPNESS

Increase the value to enhance the sharpness in your picture or vice versa. Choose zero (0) for average setting.

COLOR

Increase the value to enhance the color in your picture or vice versa. Choose zero (0) to balance the color.

- 5 Press ◀ ▶ to adjust the setting that best suits your personal preference.
- 6 Repeat steps 4~5 for adjusting other color features.
- 7 Press **OK** to confirm.

HD JPEG

You can enjoy untouched and uncompressed pictures as it's original resolution via your HDMI connection (see page 15).

- 1 In 'Video Setup Page', press ▲ ▼ to select { **HD JPEG** }, then press ▶.
- { On }
- Displays picture with high definition, the JPEG picture will be upscaled.
- { **Off** }
- Displays picture with standard definition.
- 2 Use ▲ ▼ to select a setting and press **OK** to confirm.
- In HD JPEG playback mode,
→ If you connect to CVBS output, a message 'High Definition mode' will appear on the TV screen.

Tip:

– This option only available for JPEG picture disc.

English

TIPS: The underlined option is the factory default setting.
Press ◀ to go back to previous menu item. Press **SETUP** to exit the menu item.

DVD Menu Options (continued)

HDMI Video Setup

The options included in HDMI Video Setup are: {Resolution} and {Wide Screen Format}.

- 1 In 'Video Setup Page', press ▲ ▼ to select { **HDMI Video Setup** }, then press ►.
- 2 Press ▲ ▼ to select an item, then press ► to access.
- 3 Use ▲ ▼ to select a setting and press **OK** to confirm.

Resolution

You can select the resolution of the picture according to your preference and the connected HDMI peripheral equipment.

- You can also press **HD UPSCALE** button on the DVD player front panel to switch between HDMI resolution.

{ **480p** }

Progressive output in 480 lines for NTSC TV.

{ **576p** }

Progressive output in 576 lines for PAL TV.

{ **720p** }

Progressive output upscale to 720 lines.

{ **1080i** }

Interlaced output upscale to 1080 lines.

{ **1080p** }

Progressive output upscale to 1080 lines.

{ **Auto** }

Output automatically based on your display's supported resolution. Select this to automatically display best resolution settings.

Tips:

- If no display or distorted pictures appears on the TV screen due to unsupported resolution, reconnect any available video output to your DVD player and re-adjust the resolution setting.
- When changing the resolution of the DVD player, the HDMI TV will automatically change to fit the DVD player resolution.
- {Progressive} and {TV Type} options will not be available when a HDMI cable is connected and the DVD player will turn to HDMI mode automatically.
- {HD JPEG} and {HDMI Video Setup} are only available when DVD player in HDMI mode.
- This DVD player supports 1080p at 50/60Hz, check if your TV supports 1080p at 50/60Hz.

TIPS: The underlined option is the factory default setting.
Press ◀ to go back to previous menu item. Press **SETUP** to exit the menu item.

DVD Menu Options (continued)

(For DVI TV only)

- If a DVI TV is connected (see page 16) all above resolution options can be chosen, including the resolution that are not supported by the TV.
- ① Use **▲ ▼** to select a resolution and press **OK** to confirm.
→ The menu will appear on the TV.

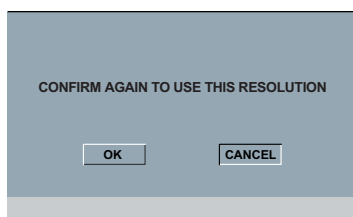

- For resolution supported by the DVI TV, the picture will be in a normal mode,
→ press **◀** to highlight **{ OK }** and press **OK** to confirm.
- For resolution that are not supported by the DVI TV, when black TV screen appears.

To deactivate resolution change manually:

→ Wait for 5 seconds for the auto recovery.

OR

- ① Press **OPEN/CLOSE ▲** on the DVD player to open the disc tray.
 - ② Press **HD UPSCALE** on the front panel to switch to the available resolution.
- For resolution that are not supported by the DVI TV, when 'snowflakes' appears on TV screen,

To deactivate resolution change manually:

→ Press **STANDBY** to reset display screen.

Wide Screen format

If the 4:3 picture need output to the 16:9 TV, you could select the following output format.

{ **Super Wide** }

The left and right side of a 4:3 video picture will be scaled in the wide direction, but the center portion of screen is stretch less then the side.

{ **4:3 Pillarbox** }

The left and right side of a 4:3 video picture will be filled with black edge on a 16:9 TV screen.

{ **Off** }

No ratio adjustment.

Tip:

– This option is only available when in high definition mode (resolution not below 720p) and when {TV Display} is set to {16:9} (see page 41 {Setting TV Display}).

TIPS: The underlined option is the factory default setting.
Press **◀** to go back to previous menu item. Press **SETUP** to exit the menu item.

DVD Menu Options (continued)

Using the Preference setup menu

- 1 Press **STOP** ■ twice to stop playback, (if any), then press **SETUP** on the remote control.
→ The system setup menu appears.

Preference Page	
Audio	
Subtitle	
Disc Menu	
Parental	
PBC	
Mp3 / Jpeg Nav	
Password	

- 2 Press ◀▶ to select { **Preference Page** }.
- 3 Press ▲▼ to select an item, then press ▶ to access.
Example: { **Parental** }
→ The options for the selected item appears.
→ If the selection in the menu is greyed out, that means the feature is not available or not possible to change at the current state.
- 4 Use ▲▼ to select a setting and press **OK** to confirm.
Example: { **8 Adult** }
→ The setting is selected and setup is complete.
- 5 To exit, press **SETUP**.

Subtitle/Audio/Disc Menu

These menus contain various language options for audio, subtitle and disc menu which may be recorded on the DVD. For details, see page 22.

Parental

Depending on the DVD, you may be asked to change the parental level while playing the disc. The rating levels are from 1 to 8 and are country dependent. You can prohibit the playing of certain discs that are not suitable for your children, or have certain discs played with alternative scenes.

- 1 In 'Preference Page', press ▼ to select { **Parental** }, then press ▶.

Preference Page	
Audio	1 KID SAFE
Subtitle	2 G
Disc Menu	3 PG
Parental	4 PG13
PBC	5 PGR
Mp3 / Jpeg Nav	6 R
Password	7 NC17

- 2 Use ▲▼ to select a rating level and press **OK** to confirm.
→ Select { **8 Adult** } to disable parental level and allow all discs to play.
- 3 Use the **alphanumeric keypad 0-9** to enter the six-digit password (see page 48 'Changing the Password'), then press **OK** to confirm.
- DVDs that are rated higher than the level you selected will not play unless you enter your six-digit password.

TIPS: The underlined option is the factory default setting.
Press ◀ to go back to previous menu item. Press **SETUP** to exit the menu item.

DVD Menu Options (continued)

Rating Explanations

{ 1. Kid Safe }

Childsafe; acceptable for viewers of all ages.

{ 2. G }

General Audience; recommended as acceptable for viewers of all ages.

{ 3. PG }

Parental Guidance suggested.

{ 4. PG – 13 }

Unsuitable for children under age 13.

{ 5. PG – R }

Parental Guidance; recommended that parents restrict children under 17 from viewing.

{ 6. R }

Restricted; recommended only when supervised by a parent or adult guardian.

{ 7. NC – 17 }

No Children under age 17; not recommended viewing for children under age 17.

{ 8. Adult }

Mature Material; should be viewed only by adults due to graphic sexual material, violence or language.

Tips:

- This feature will not limit viewing if the disc manufacturer did not code the disc.
- VCD, SVCD, CD have no level indication, so parental control has no effect on these type of discs. This also applies to most illegal DVDs.
- Some DVDs are not coded with a rating though the movie rating may be printed on the disc cover. The rating level feature does not prohibit play of such discs.

PBC

You can set the PBC to {On} or {Off}. This feature is available only on SVCD or Video CD 2.0 with playback control (PBC) feature. For details, see page 29.

MP3/JPEG Menu

MP3/JPEG Navigator can be set only if the disc is recorded with menu. It allows you to select different display menu for easy navigation.

- 1 In 'Preference Page', press ▲ ▼ to select { MP3/JPEG Nav }, then press ►.

{ Without Menu }

Select this to display all the files contained in the MP3/Picture CD.

{ With Menu }

Select this to display only the folder menu of the MP3/Picture CD.

- 2 Use ▲ ▼ to select a setting and press **OK** to confirm.

Tip:

- This feature is not available for selection in USB mode.

TIPS: The underlined option is the factory default setting. Press ◀ to go back to previous menu item. Press **SETUP** to exit the menu item.

DVD Menu Options (continued)

Changing the Password

You need to enter your six-digit password to play a prohibited disc or if prompted for a password. The same default password is used for both Parental and Disc Lock.

- 1 In 'Preference Page', press ▲ ▼ to select { **Password** }, then press ► to select { **Change** }.
- 2 Press **OK** and the menu appears on the TV screen.

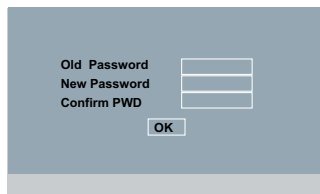

- 3 Use the **alphanumeric keypad 0-9** to enter the six-digit password.
 - When doing this for the first time, enter the default password '136900'.
- If you forget your old six-digit password, enter the default password '136900'.
- 4 Enter the new six-digit password.
- 5 Enter the new six-digit password a second time to confirm.
 - The new six-digit password will now take effect.
- 6 Press **OK** to confirm.

Setting the DivX® subtitle font

You can set the font type that supports the recorded DivX® subtitle.

- 1 In 'Preference Page', press ▲ ▼ to select { **DivX® Subtitle** }, then press ►.
 - { **Standard** }
 - Albanian, Danish, Dutch, English, Finnish, French, Gaelic, German, Italian, Kurdish (Latin), Norwegian, Portuguese, Spanish Swedish and Turkish.
- 2 Press **OK** to confirm.

Restoring to the original settings

Setting the { **Default** } function will reset all options and your personal settings to the factory defaults, except your Parental and Disc Lock.

- 1 In 'Preference Page', press ▲ ▼ to select { **Default** }, then press ► to select { **Reset** }.
- 2 Press **OK** to confirm.
 - All settings will now reset to factory defaults.

TIPS: The underlined option is the factory default setting.
Press ◀ to go back to previous menu item. Press **SETUP** to exit the menu item.

Software upgrade

Periodically Philips will issue software upgrade to enhance your user experience.

IMPORTANT!

– **Power supply must not be interrupted during upgrade!**

To check the current software version of this DVD player;

- 1 Press **OPEN/CLOSE ▲** on the DVD player to open the disc tray.
→ The disc tray will open.
- 2 Press **numeric keypad '55'** on the remote control.
→ The file name of the software installed in the DVD player appears on the TV screen.

To download and install the latest software to the DVD player;

- 1 Visit the Philips website 'www.philips.com/support' to check the availability of the latest software upgrade.
- 2 Download the software to a CD-R.
- 3 Insert the CD-R to the disc slot.
→ The menu appears on the TV screen.

Upgrade File Detected

Upgrade?

Press Play to start

- 4 Press **PLAY/PAUSE ►II** to download the latest software in the DVD player.
→ The DVD player will restart automatically once the download complete.

Troubleshooting

WARNING

Under no circumstances should you try to repair the system yourself, as this will invalidate the warranty. Do not open the system as there is a risk of electric shock.

If a fault occurs, first check the points listed below before taking the system for repair. If you are unable to remedy a problem by following these hints, consult your dealer or Philips for help.

Problem	Solution
No power.	<ul style="list-style-type: none"> – Press STANDBY-ON button on the front of the DVD player to turn on the system. – Make sure the AC outlet has power.
Remote control does not work.	<ul style="list-style-type: none"> – Aim the remote control directly at the sensor on the front of the DVD player (not towards TV). – Remove any obstacles between DVD player and the remote control. – Batteries are weak, replace the batteries. – Check the polarities of the batteries are as indicated on the remote control (± signs).
No picture.	<ul style="list-style-type: none"> – Turn on your TV and set to the correct Video In channel for the DVD player. You may go to Channel 1 on your TV, then press the channel down button on your TV's remote control until you see the TV program. – Check the video connection between the DVD player and the TV.
The picture is distorted or black & white during playback.	<ul style="list-style-type: none"> – The disc does not match with the TV color system standard (PAL/NTSC). – The disc is dirty, clean the disc. – Sometimes a small amount of picture distortion may appear. This is not a malfunction. – To deactivate progressive scan function manually; <ol style="list-style-type: none"> 1) Turn off your TV progressive scan mode (or set to interlaced mode) 2) Press OPEN/CLOSE to open the DVD player disc tray. 3) Press the alphanumeric keypad '1' for few seconds.
No sound.	<ul style="list-style-type: none"> – Check the audio connections, the red and white jacks are connected correctly. – Set the Digital output correctly, based on the equipment you connected to the DVD player.
Disc does not play.	<ul style="list-style-type: none"> – Insert the disc with the label facing up. – Wrong region code. – Wrong disc type. Read chapter "Playback from Disc - Playable discs" for details. – Make sure the disc is not scratched or warped. Clean the disc or replace a new one. – Check if the disc is defective by trying another disc.

Troubleshooting (continued)

Problem	Solution
The aspect ratio of the screen cannot be changed.	<ul style="list-style-type: none"> – The aspect ratio is fixed on the DVD disc. – Depending on the TV, it may not be possible to change the aspect ratio.
Not able to select some items in the setup/system menu.	<ul style="list-style-type: none"> – Press STOP button twice before selecting the setup/system menu. – Depending on the disc availability, some menu items cannot be selected.
The DVD player does not start playback.	<ul style="list-style-type: none"> – Insert a readable disc with the playback side facing down. – Check the disc type, colour system (PAL/NTSC) and region code. – Check for any scratches or smudges on the disc. – Press SETUP to turn off the setup menu screen. – You may need to enter the password in order to change the parental rating level or to unlock the disc for playback. – Moisture may have condensed inside the system. Remove the disc and leave the system turned on for about an hour. – Disconnect the power cord from the power outlet for a few minutes. Reconnect the power cord and try to operate again as usual.
Picture freezes momentarily during playback.	<ul style="list-style-type: none"> – Check the disc for fingerprint/scratches and clean with a soft cloth wiping from center to edge.
Unable to select Progressive Scan on/off.	<ul style="list-style-type: none"> – Check that the output of the video signal is turn to { YPbPr }.
Unable to play DivX® movies.	<ul style="list-style-type: none"> – Check that the DivX® file is encoded in 'Home Theatre' mode with DivX® 5.x encoder. – Check that the DivX® movie downloaded is a complete file.
No sound during DivX® movies playback.	<ul style="list-style-type: none"> – The audio codec may not be supported by this DVD player.
An DivX® movies does not repeat.	<ul style="list-style-type: none"> – Check that file size of the movie does not exceed the file size of the disc during downloading.
Certain DivX® files does not play or are skipped.	<ul style="list-style-type: none"> – Make sure the file name extension is correct. You can check this using a computer with CD-ROM. – The player is designed to playback DVD, VCD, CD audio, MP3 and DivX® discs only. Other digital audio formats such as liquid audio, RM (RealMedia), WAV or non-audio files like '.doc', '.txt', '.pdf' are not supported. – Try to play the problem DivX® files, on a computer. If they do not work, the source file appears to be corrupt. – Try to download the file again from a different source, or if you have created the file yourself, create the file again and make sure the settings are correct.

Troubleshooting (continued)

English

Problem	Solution
The contents of the USB flash drive cannot be read	<ul style="list-style-type: none"> - The USB flash drive format is not compatible with the DVD player. - Drive is formatted with a different file system. (e.g. NTFS)
Slow operation of the USB flash drive	<ul style="list-style-type: none"> - Big file size or high resolution USB flash driver takes longer time to read and display on the TV screen.
No HDMI video output	<ul style="list-style-type: none"> - HDMI connection can only be made to HDMI-equipped devices with HDCP (High Bandwidth Digital Content Protection). Use a separate adaptor (DVI to HDMI) for DVI TV connection (equipped with HDCP). - Make sure the resolution of this DVD player matches the TV device you have connected using the HDMI; 480p/576p/720p/1080i/1080p and this DVD player supports 1080p at 50/60Hz only. - When connecting to a non-HDCP complaint TV, the HDCP warning message will appear. - When the HDMI and RGB video connection are used at the same time, there will be no picture output from the RGB video connection, disconnect the HDMI cable. - Press HD UPSCALE if no picture on the TV screen after power off and on. - Check the connection between the TV and HDMI of DVD player. - During resolution selection for DVI TV, a distorted or black screen may appear, see HDMI Video Setup.
No HDMI audio output	<ul style="list-style-type: none"> - There will be no sound from the HDMI output if the source device is only DVI/HDCP (High Bandwidth Digital Content Protection)- compatible. - It is not possible to output SACD or copy-controlled DVD audio sources from the HDMI connection.

Specifications

TV STANDARD(PAL/50Hz)(NTSC/60Hz)

Number of lines	625	525
Playback	Multistandard(PAL/NTSC)	

VIDEO PERFORMANCE

Video DAC	12 bit, 108 MHz	
YPbPr	0.7 Vpp ~ 75 ohm	
Video Output	1Vpp ~ 75 ohm	

VIDEO FORMAT

Digital	MPEG 2 for DVD,SVCD	
Compression	MPEG 1 for VCD DivX®	

DVD	50Hz	60Hz
Horiz. resolution	720 pixels	720 pixels
	1920 pixels	1920 pixels
Vertical resolution	576 lines	480 lines
	1080 lines	1080 lines

VCD	50Hz	60Hz
Horiz. resolution	352 pixels	352 pixels
Vertical resolution	288 lines	240 lines

AUDIO FORMAT

Digital	MPEG/ AC-3/ PCM	compressed Digital 16, 20, 24 bits fs, 44.1, 48, 96 kHz
	MP3(ISO 9660)	96, 112, 128, 256, 320kbps & variable bit rate fs, 32, 44.1, 48 kHz

Analog Sound Stereo
Dolby Surround compatible downmix from Dolby
Digital multi-channel sound

AUDIO PERFORMANCE

DA Converter	24 bit, 192 kHz	
DVD	fs 96 kHz	4Hz- 44kHz
	fs 48 kHz	4Hz- 22kHz
SVCD	fs 48 kHz	4Hz- 22kHz
	fs 44.1kHz	4Hz- 20kHz
CD/VCD	fs 44.1kHz	4Hz- 20kHz
Signal-Noise (1kHz)	> 90 dB	
Dynamic range(1kHz)	> 80 dB	
Crosstalk (1kHz)	> 70 dB	
Distortion/noise (1kHz)	> 65 dB	
MPEG MP3	MPEG Audio L3	

CONNECTIONS

YPbPr Output	Cinch 3x
Video Output	Cinch (yellow)
Audio Output(L+R)	Cinch (white/red)
Digital Output	1 coaxial IEC60958 for CDDA / LPCM IEC61937 for MPEG 1/2, Dolby Digital
HDMI Output	

CABINET

Dimensions (w x h x d)	435 x 38 x 210 mm
Weight	Approximately 2 kg

POWER CONSUMPTION

Power Supply Rating	110V – 240V; 50/60Hz
Power consumption	< 12 W
Power consumption in Standby mode	< 1 W

Frequently Asked Questions (USB)

Why does it take so long to display the contents on my USB device?

- This could be due to the large numbers of files (>500 files/folders) or size of the files (>1MB.)
- There could be other non-supported files in the device that the system is trying to read/display.

What if un-supported devices (e.g. USB mouse, keyboards) are plugged into the player?

- The device may cause the player to be unstable. Remove the unsupported device and unplug the mains cord. Wait for a few minutes before reconnecting the mains cord and power on the player again.

What happens when I plug in a USB HDD?

- HDD is not supported as the large storage capacity makes navigation very difficult. Transfer the music files (mp3) and photos (jpg) into a flash drive.

Why does the system fail to detect my USB portable music player?

- The portable music player may require propriety software that is bundled with our player in order to access the contents (eg. playlist.)

Why can't some devices be playback from USB Port on my player?

- USB Port only offer 500mA current, could not power up HDD players which require more current.
- Device which shows USB Mass Storage Device might actually be USB Hub when detect in USB analyser.
- Devices in NTFS format can't be supported.
- Devices require drivers to be installed will not supported by this player. They are not UMS or MTP devices, which does not require any driver installation or start up disc. When in UMS or MTP mode, the device is treated as an external HDD or portable device.

What types of file does the player support?

- We support only FAT16 and FAT32, not NTFS.

Why does the file name appear to be different from what was displayed on my computer (e.g. from "Good Bye. jpg" to "Good_B~1.jpg")?

- The length of the file name is restricted by the file system of the device (FAT16), which only supports eight (8) characters.
- The computer may be able to display the full file name as the operating system can convert the file system.

Is simultaneous USB and Disc playback possible?

- This is not possible due to memory limitation. In addition, a different user interface will be needed in order to function and in order to be simple enough to use.

Why can't I rotate the pictures in my device?

- In order to rotate the pictures in the USB device, the picture must contain EXIF information, stored by most digital cameras. This EXIF information may have been removed when you edit or copy the picture from other devices using editing programs.

Why can't the player play some of my music files, photos or movies?

- The music files may not be playable because of different formats and encoding bit-rates. Similarly, the photos may be of low resolution or too high resolution for the player to support.

Glossary

English

Analog: Sound that has not been turned into numbers. Analog sound varies, while digital sound has specific numerical values. These jacks send audio through two channels, the left and right.

Aspect ratio: The ratio of vertical and horizontal sizes of a displayed image. The horizontal vs. vertical ratio of conventional TVs. is 4:3, and that of wide-screens is 16:9.

AUDIO OUT Jacks: Jacks on the back of the DVD System that send audio to another system (TV, Stereo, etc.).

Bit Rate: The amount of data used to hold a given length of music; measured in kilobits per seconds, or kbps. Or, the speed at which you record. Generally, the higher the bit rate, or the higher the recording speed, the better the sound quality. However, higher bit rates use more space on a Disc.

Chapter: Sections of a picture or a music piece on a DVD that are smaller than titles. A title is composed of several chapters. Each chapter is assigned a chapter number enabling you to locate the chapter you want.

Component Video Out Jacks: Jacks on the back of the DVD System that send high-quality video to a TV that has Component Video In Jacks (R/G/B, Y/Pb/Pr, etc.).

Disc menu: A screen display prepared for allowing selection of images, sounds, subtitles, multi-angles, etc recorded on a DVD.

Digital: Sound that has been converted into numerical values. Digital sound is available when you use the DIGITAL AUDIO OUT COAXIAL or OPTICAL jacks. These jacks send audio through multiple channels, instead of just two channels as analog does.

DivX® 3.11/4.x/5.x/6.0: The DivX® codec is a patent-pending, MPEG-4 based video compression technology, developed by DivX® Networks, Inc., that can shrink digital video to sizes small enough to be transported over the internet, while maintaining high visual quality.

Dolby Digital: A surround sound system developed by Dolby Laboratories containing up to six channels of digital audio (front left and right, surround left and right, center and subwoofer).

JPEG: A very common digital still picture format. A still-picture data compression system proposed by the Joint Photographic Expert Group, which features small decrease in image quality in spite of its high compression ratio.

MP3: A file format with a sound data compression system. 'MP3' is the abbreviation of Motion Picture Experts Group 1 (or MPEG-1) Audio Layer 3. By using MP3 format, one CD-R or CD-RW can contain about 10 times as much data volume as a regular CD can.

Parental Control: A function of the DVD to limit playback of the disc by the age of the users according to the limitation level in each country. The limitation varies from disc to disc; when it is activated, playback will be prohibited if the software's level is higher than the user-set level.

PCM (Pulse Code Modulation): A system for converting analog sound signal to digital signal for later processing, with no data compression used in conversion.

Playback control (PBC): Refers to the signal recorded on video CDs or SVCDs for controlling reproduction. By using menu screens recorded on a Video CD or SVCD that supports PBC, you can enjoy interactive-type software as well as software having a search function.

Progressive Scan: It displays all the horizontal lines of a picture at one time, as a signal frame. This system can convert the interlaced video from DVD into progressive format for connection to a progressive display. It dramatically increases the vertical resolution.

Region code: A system for allowing discs to be played back only in the region designated beforehand. This unit will only play discs that have compatible region codes. You can find the region code of your unit by looking on the product label. Some discs are compatible with more than one region (or ALL regions).

Title: The longest section of a picture or music feature on DVD, music, etc., in video software, or the entire album in audio software. Each title is assigned a title number enabling you to locate the title you want.

TV OUT jack: Jack on the back of the DVD System that sends video to a TV.

WMA: Windows Media Audio. Refers to an audio compression technology developed by Microsoft Corporation. WMA data can be encoded by using Windows Media Player version 9 or Windows Media Player for Windows XP. Files are recognized by their file extension "WMA."

HDMI: High Definition Multimedia Interface. A specification developed by the HDMI Working Group that combines multi-channel audio and high definition video and that controls signals into a single digital interface for use with DVD player, digital television, and other audiovisual devices.