

Register your product and get support at  
[www.philips.com/welcome](http://www.philips.com/welcome)

HTS7200



---

EN User manual

---

DE Benutzerhandbuch

---

ES Manual del usuario

---

FR Mode d'emploi

---

NL Gebruiksaanwijzing

**PHILIPS**





# Contents

---

<b>1 Important</b>	4
Safety and important notice	4
Trademark notice	5
Care	6

---

<b>2 Your product</b>	7
Feature highlights	7
Product overview	8

---

<b>3 Connect</b>	11
Place the product	11
Connect video cables	11
Connect speaker cables to speakers	13
Connect speakers and subwoofer	13
Connect radio antenna	13
Connect audio cables/other devices	14
Connect LAN	16
Connect power cord	16

---

<b>4 Get started</b>	17
Insert the remote control batteries	17
Find the correct viewing channel	17
Use the Home menu	18
Select menu display language	18
Set up network	18
Use Philips EasyLink	19

---

<b>5 Play</b>	21
Play a disc	21
Play video	22
Play music	25
Play photo	26
Play from USB device	27
Play from portable media player	28
Play from radio	28

---

<b>6 Adjust sound</b>	30
Control the volume	30
Change treble and bass	30
Select surround sound	30
Select preset sound	30

---

<b>7 Adjust settings</b>	31
Video Setup	31
Audio Setup	32
Preference Setup	33
EasyLink Setup	34
Advanced Setup	35

---

<b>8 Update software</b>	37
Update software via network	37
Update software via USB	37

---

<b>9 Specifications</b>	38
-------------------------	----

---

<b>10 Troubleshooting</b>	39
---------------------------	----

---

<b>11 Glossary</b>	41
--------------------	----

# 1 Important

---

## Safety and important notice



### Warning

- Risk of overheating! Never install the product in a confined space. Always leave a space of at least 4 inches around the product for ventilation. Ensure curtains or other objects never cover the ventilation slots on the product.
- Never place the product, remote control or batteries near naked flames or other heat sources, including direct sunlight.
- Only use this product indoors. Keep this product away from water, moisture and liquid-filled objects.
- Never place this product on other electrical equipment.
- Keep away from this product during lightning storms.
- Where the mains plug or an appliance coupler is used as the disconnect device, the disconnect device shall remain readily operable.
- Visible and invisible laser radiation when open. Avoid exposure to beam.



This product is in compliance with the essential requirements and other relevant provisions of Directives 2006/95/EC (Low Voltage) and 2004/108/EC (EMC).

---

## Copyright



Be responsible  
Respect copyrights

This product incorporates copyright protection technology that is protected by method claims of certain U.S. patents and other intellectual property rights owned by Macrovision Corporation and other rights owners. Use of this copyright protection technology must be authorised by Macrovision Corporation, and is intended for home and other limited viewing uses only unless otherwise authorised by Macrovision Corporation. Reverse engineering or disassembly is prohibited.

### Copyright in the U.K.

Recording and playback of material may require consent. See Copyright Act 1956 and The Performers' Protection Acts 1958 to 1972.

---

## Mains fuse (UK only)

This product is fitted with an approved moulded plug. Should it become necessary to replace the mains fuse, this must be replaced with a fuse of the same value as indicated on the plug (example 10A).

- 1 Remove fuse cover and fuse.
- 2 The replacement fuse must comply with BS 1362 and have the ASTA approval mark. If the fuse is lost, contact your dealer in order to verify the correct type.
- 3 Refit the fuse cover.



### Note

- To conform to the EMC directive (2004/108/EC), the mains plug on this product must not be detached from the mains cord.

## Disposal of your old product and batteries



Your product is designed and manufactured with high quality materials and components, which can be recycled and reused.



When this crossed-out wheeled bin symbol is attached to a product it means that the product is covered by the European Directive 2002/96/EC. Please inform yourself about the local separate collection system for electrical and electronic products.

Please act according to your local rules and do not dispose of your old products with your normal household waste.

Correct disposal of your old product helps to prevent potential negative consequences for the environment and human health.



Your product contains batteries covered by the European Directive 2006/66/EC, which cannot be disposed with normal household waste.

Please inform yourself about the local rules on separate collection of batteries because correct disposal helps to prevent negative consequences for the environmental and human health.

## Trademark notice



HDMI, and HDMI logo and High-Definition Multimedia Interface are trademarks or registered trademarks of HDMI licensing LLC.



Windows Media and the Windows logo are trademarks, or registered trademarks of Microsoft Corporation in the United States and/or other countries.



The USB-IF Logos are trademarks of Universal Serial Bus Implementers Forum, inc.



DivX, DivX Ultra Certified, and associated logos are trademarks of DivX, Inc. and are used under license.

Official DivX® Ultra Certified product. Plays all versions of DivX® video (including DivX® 6) with enhanced playback of DivX® media files and the DivX® Media Format. Plays DivX® video with menus, subtitles and audio tracks.



'DVD Video' is a trademark of DVD Format/ Logo Licensing Corporation.



'Blu-ray Disc' and the 'Blu-ray Disc' logo are trademarks.

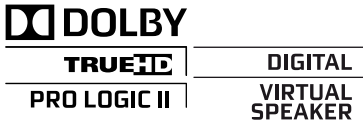

Manufactured under licence from Dolby Laboratories. Dolby and the double-D symbol are trademarks of Dolby Laboratories.



Manufactured under licence under U.S. Patent #s: 5,451,942; 5,956,674; 5,974,380; 5,978,762; 6,487,535; & other U.S. and worldwide patents issued & pending. DTS is a registered trademark and the DTS logos, Symbol, DTS-HD and DTS-HD Advanced Digital Out are trademarks of DTS, Inc. © 1996-2008 DTS, Inc. All Rights Reserved.



Java and all other Java trademarks and logos are trademarks or registered trademarks of Sun Microsystems, Inc. in the United States and/or other countries.



**BONUSVIEW™**

'BD LIVE' and 'BONUSVIEW' are trademarks of the Blu-ray Disc Association.



'AVCHD' and the 'AVCHD' logo are trademarks of Matsushita Electric Industrial Co., Ltd and Sony Corporation.

**x.v.Colour**

'x.v.Colour' is a trademark of Sony Corporation.



ENERGY STAR and the ENERGY STAR mark are registered U.S. trademarks.

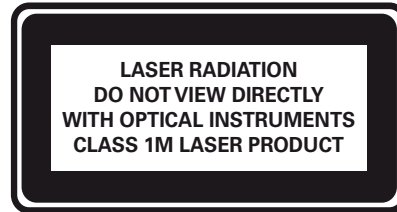

---

## Care

**!** Caution

- Never use solvents such as benzene, thinner, cleaners available commercially or anti-static sprays intended for discs.

### Clean discs

Wipe the disc with a micro fibre cleaning cloth from the centre to the edge in a straight line movement.

## 2 Your product

Congratulations on your purchase, and welcome to Philips! To fully benefit from the support that Philips offers; register your product at [www.philips.com/welcome](http://www.philips.com/welcome).

### Feature highlights

#### Philips EasyLink

Your product supports Philips EasyLink, which uses the HDMI CEC (Consumer Electronics Control) protocol. EasyLink-compliant devices that are connected through HDMI connectors can be controlled by a single remote control.

#### Note

- Philips does not guarantee 100% interoperability with all HDMI CEC devices.

#### High-Definition entertainment

Watch a high-definition content disc with HDTV (High Definition Television). Connect it through a high speed HDMI cable (1.3 or category 2). You can enjoy excellent picture quality up to 1080p resolution with the frame rate of 24 frames per second with progressive scan output.

#### BONUSVIEW/PIP (Picture-in-Picture)

This is a new function of BD-Video that plays the primary video and secondary video simultaneously. Blu-ray players with Final Standard Profile or Profile 1.1 specs can play Bonus View features.

#### BD-Live

Connect this product to the movie studios' website via the LAN port to access a variety of up-to-date content (e.g. refreshed previews and exclusive special features). You can also enjoy next generation possibilities, such as ringtone/wallpaper downloads, peer-to-peer interactions, live events and gaming activities.

### Region codes

You can play discs with the following region codes.

Region code		Country
DVD	BD	
		 Europe, United Kingdom
		 Asia Pacific, Taiwan, Korea
		 Latin America
		 Australia, New Zealand,
		 Russia, India
		 China



# Product overview

## Main unit

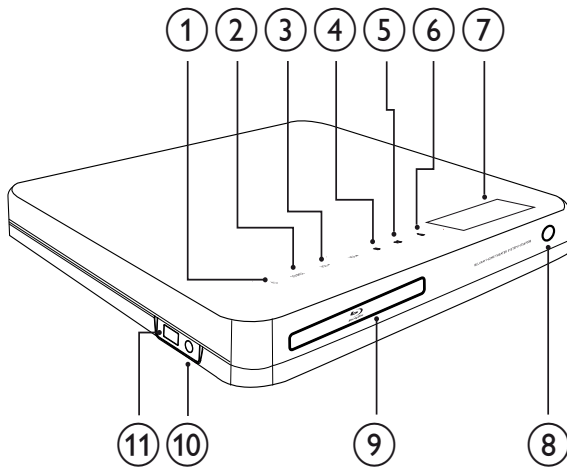

- ① **⏻ (Standby-On)**  
Turn on the Home Theatre System or switch to standby mode.
- ② **SOURCE**  
Select media to play or listen to audio from the connected device.
- ③ **VOL +/-**  
Increase or decrease volume.
- ④ **■ (Stop)**
  - Stop play.
  - Press and hold to erase the preset radio station.
- ⑤ **▶|| (Play/Pause)**
  - Start, pause or resume play.
  - In radio mode, automatically tune radio stations during first-time setup.
- ⑥ **▲ (Open/Close)**  
Open or close the disc compartment.
- ⑦ **Display panel**
- ⑧ **IR sensor**  
Detect signals from the remote control. Point the remote control directly at the sensor.

- ⑨ **Disc compartment**
- ⑩ **MP3 LINK jack**  
Connect a portable audio player.
- ⑪ **USB jack**  
Connect a USB supported device.

## Remote control

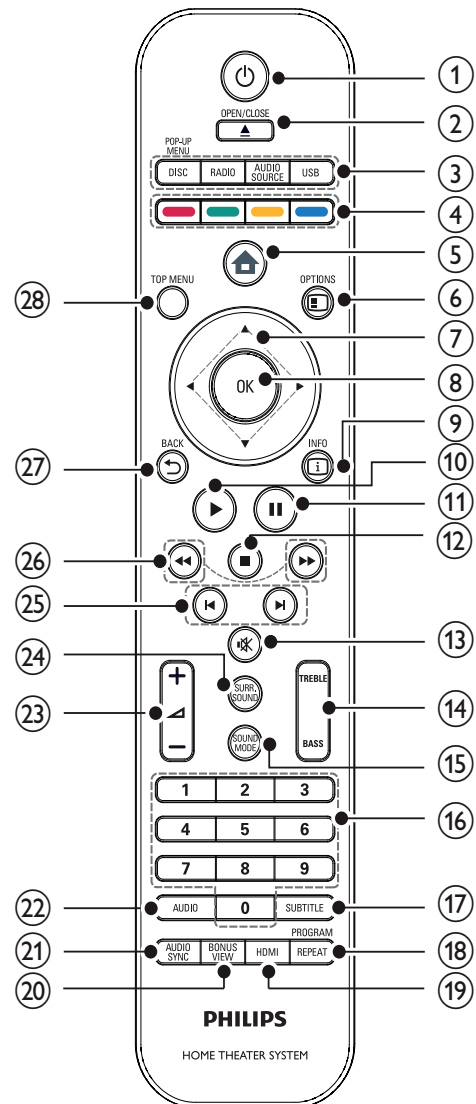

- ① **⏻ (Standby-On)**
- Turn on the home theatre or switch it to standby mode.
  - When EasyLink is enabled, press and hold for at least three seconds to turn all connected HDMI CEC-compliant devices to standby.

- ② **▲ OPEN/CLOSE**  
Open or close the disc compartment.

- ③ **Source buttons**
- **DISC / POP-UP MENU:** Switch to disc source. Access to disc menu during play.
  - **RADIO:** Switch to FM radio.
  - **USB:** Switch to the connected USB device.
  - **AUDIO SOURCE:** Select an audio input.

Display	Device connected to
AUX1	AUDIO IN-AUX1
AUX2	AUDIO IN-AUX2
COAX IN	DIGITAL IN-COAXIAL
OPTI IN	DIGITAL IN-OPTICAL
MP3 LINK	MP3 LINK

- ④ **Colour buttons**  
Blu-ray discs only: Select a task or option.

- ⑤ **🏠 (Home menu)**  
Access the home menu.

- ⑥ **☰ OPTIONS**  
Access options for the current activity or selection.

- ⑦ **▲▼◀▶ (Navigation buttons)**  
Navigate menus.

- ⑧ **OK**  
Confirm an entry or selection.

- ⑨ **ℹ INFO**  
Display information about what is playing.

- ⑩ **▶ (Play)**  
Start or resume play.

- ⑪ **⏸ (Pause)**
- Pause play.
  - Move the paused picture one step forward.

- ⑫ **■ (Stop)**
- Stop play.
  - Press and hold to erase the preset radio station.

- ⑬ **🔇 (Mute)**  
Mute or restore audio output.

- ⑭ **TREBLE / BASS**  
Change treble or bass. Use with +/-.

- ⑮ **SOUND MODE**  
Select a sound mode.

- ⑯ **Numeric buttons**  
Select an item or setting.

- ⑰ **SUBTITLE**  
Select a subtitle language for video.

- ⑱ **REPEAT / PROGRAM**
- Toggle between various repeat or shuffle modes.
  - In radio mode, press to start manual radio preset; press and hold to start automatic radio preset.

- ⑲ **HDMI**  
Select the video resolution of HDMI output from the home theatre.

- ⑳ **BONUS VIEW**  
Blu-ray discs only: Enable or disable the Bonus View/Picture-In-Picture feature.

- ㉑ **AUDIO SYNC**  
Synchronise audio with video. Use with +/-.

- ㉒ **AUDIO**
- In video mode, toggle between audio languages.
  - In radio mode, toggle between stereo and mono.

- ㉓ **◀ +/- (Volume +/-)**  
Increase or decrease volume.

②④ **SURR. SOUND**

- Switch audio output to multi-channel surround or stereo mode.
- For HTS7200 only: Switch audio output to DOLBY Virtual speaker or Stereo mode.

②⑤ **◀ / ▶ (Previous/Next)**

- In video mode, skip to previous or next title, chapter or track.
- In radio mode, select a preset radio station.

②⑥ **◀◀ / ▶▶ (Fast Backward / Fast Forward)**

Fast reverse or fast forward. Press repeatedly to change the search speed.

②⑦ **↶ BACK**

Return to a previous menu screen.

②⑧ **TOP MENU**

Access the main menu of a video disc.

# 3 Connect

Make the following connections to use your Home Theatre System. For a comprehensive interactive guide, see [www.connectivityguide.philips.com](http://www.connectivityguide.philips.com).

## Basic connections:

- Video
- Speakers and subwoofer
- Power

## Optional connections:

- Radio antenna
- Audio
  - Audio from TV
  - Audio from cable box/recorder/game console
- Other devices
  - Portable media player
  - USB device
- LAN (Network)

### Note

- Refer to the type plate at the back or bottom of the product for identification and supply ratings.
- Before you make or change any connections, ensure that all devices are disconnected from the socket.

## Place the product

- Place the product where it cannot be pushed, pulled over or knocked down. Do not place it in an enclosed cabinet.
- Make sure that you have full access to the power cord for easy disconnection of the product from the power supply.

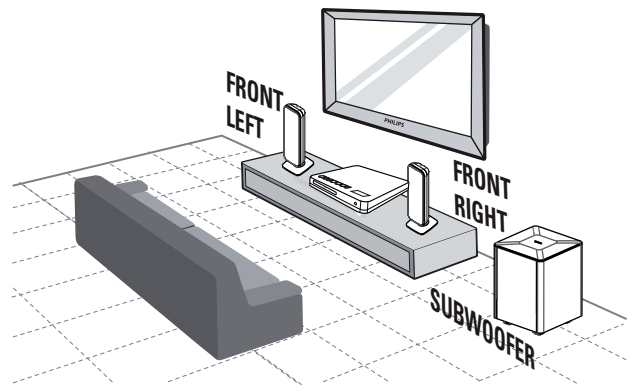

- 1 Place this Home Theatre System near to the TV
- 2 Place the speakers system at normal listening ear-level and directly parallel to the listening area.
- 3 Place the subwoofer at the corner of the room or at least 1 metre (3 feet) away from the TV.

### Tip

- To avoid magnetic interference or unwanted noise, never place this home theatre too close to any radiation devices.

## Connect video cables

Connect this Home Theatre System to a TV to view disc play. Select the best video connection that the TV can support.

- Option 1: Connect to the HDMI jack (for a HDMI, DVI or HDCP-compliant TV).
- Option 2: Connect to the component video jacks (for a standard TV or progressive scan TV).
- Option 3: Connect to the video (CVBS) jack (for a standard TV).

### Note

- You must connect this Home Theatre System directly to a TV.

## Option 1: Connect to the HDMI jack

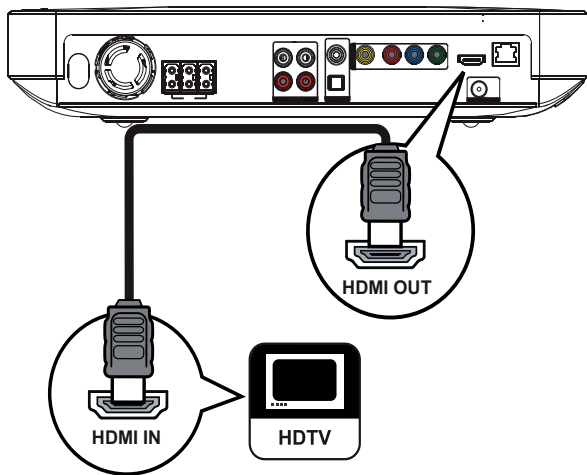

- 1 Connect the HDMI cable to the **HDMI OUT** jack on this Home Theatre System and the HDMI input jack on the TV.

### Tip

- If the TV has a DVI connector only, connect via a HDMI/DVI adapter. Connect an audio cable for sound output.
- You can optimise the video output. Press **HDMI** repeatedly to select the best resolution the TV can support.
- To play back the digital video images of a BD-video or DVD-video via an HDMI connection, it is necessary that both the Home Theatre System and the display device support a copyright protection system called HDCP (high-bandwidth digital content protection system).
- This type of connection provides the best picture quality.

## Option 2: Connect to the component video jack

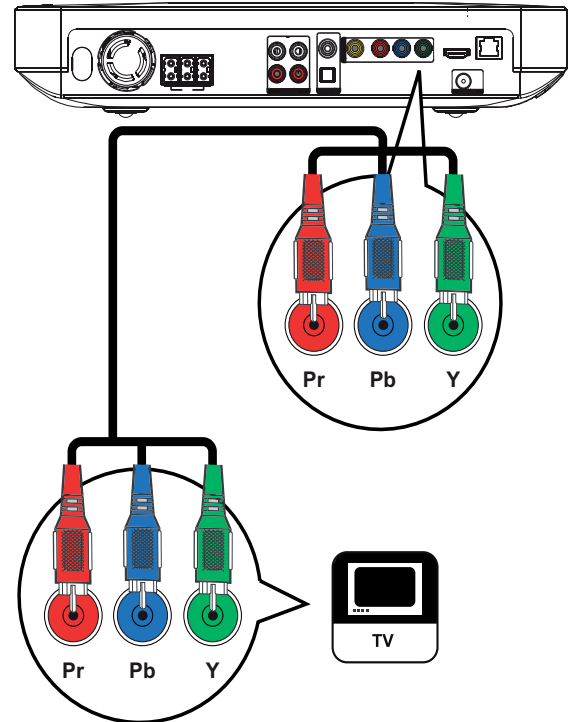

- 1 Connect the component video cable (not supplied) to the **Y Pb Pr** jacks on this Home Theatre System and the **COMPONENT VIDEO** input jacks on the TV.

### Note

- The component video input jack on the TV might be labelled as **Y Pb Pr**, **Y Cb Cr** or **YUV**.
- This type of connection provides good picture quality.

### Option 3: Connect to the Video (CVBS) jack

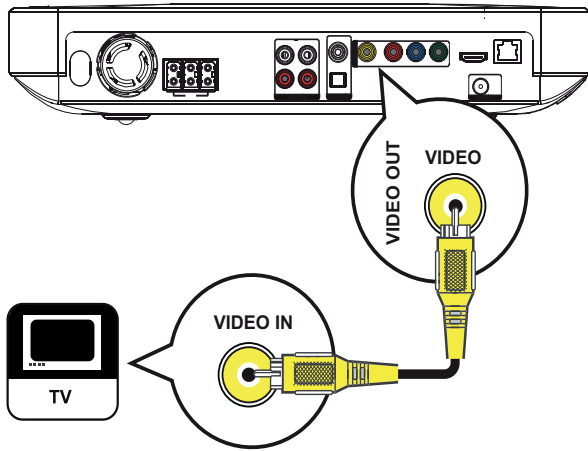

- 1 Connect a composite video cable (not supplied) to the **VIDEO** jack on this Home Theatre System and the **VIDEO** input jack on the TV.

#### Note

- The video input jack on the TV might be labelled as **A/V IN**, **VIDEO IN**, **COMPOSITE** or **BASEBAND**.
- This type of connection provides standard picture quality.

### Connect speaker cables to speakers

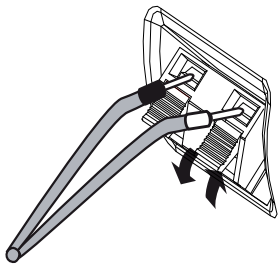

- 1 Match the colour of the cable to the terminal tab.
- 2 Press the terminal tab down and insert the stripped end of the speaker cable, then release.

### Connect speakers and subwoofer

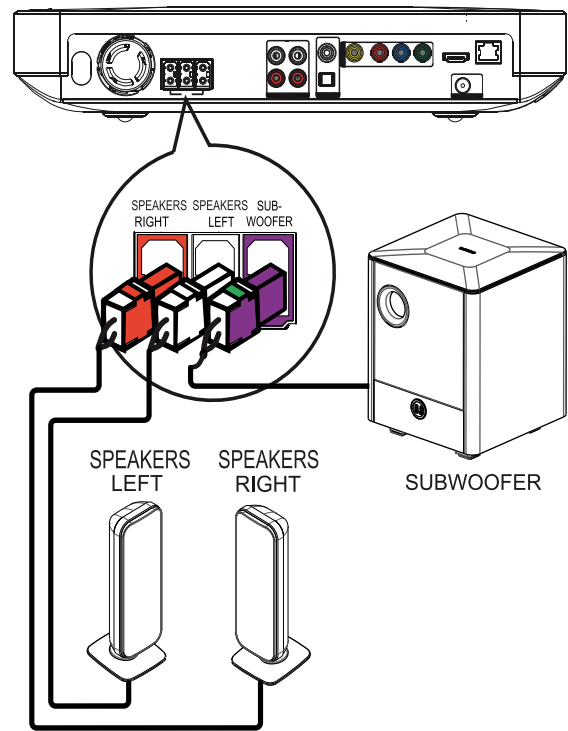

- 1 Connect the speakers and subwoofer to the matching jacks on this Home Theatre System.

#### Note

- Ensure that the colours of the plugs and jacks are matched.

### Connect radio antenna

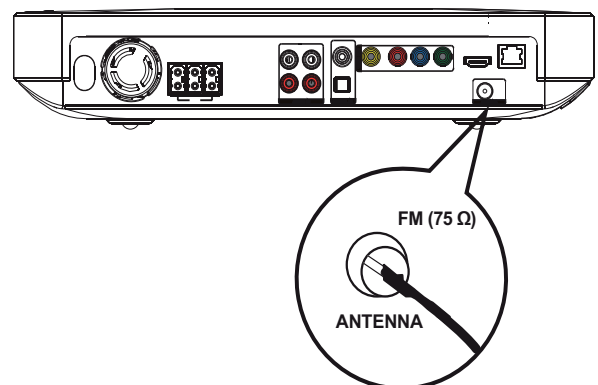

- 1 Connect the FM antenna to the **FM75Ω** jack on this Home Theatre System (for some models, this cable is already connected).
- 2 Extend the FM antenna and fix its ends to the wall.



**Tip**

- For better FM stereo reception, connect to an external FM antenna.

## Connect audio cables/other devices

Route the audio from other devices to this Home Theatre System to enjoy audio play with multi-channel surround capabilities.

### Connect audio to TV

(also used for EasyLink control)

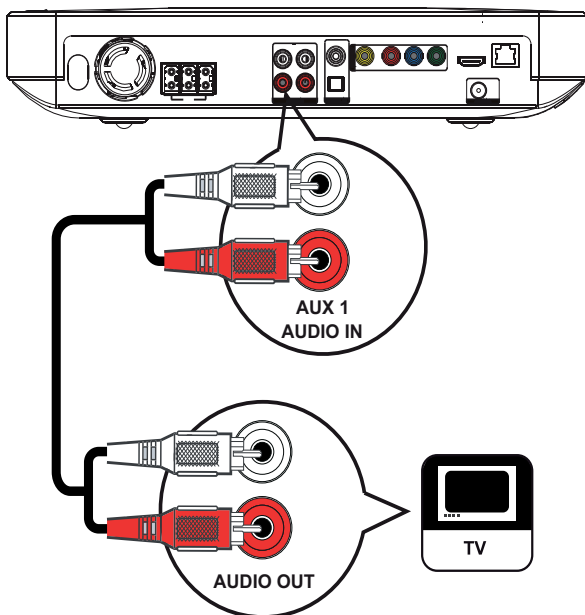

- 1 Connect the audio cables (not supplied) to the **AUDIO IN-AUX1** jacks on this Home Theatre System and the AUDIO output jacks on the TV.

### Note

- To listen to the audio output from this connection, press **AUDIO SOURCE** repeatedly until 'AUX1' is displayed on the display panel.

## Connect audio from a cable box, recorder or games console

You can choose to connect to analogue or digital jacks depending on the device capabilities.

### Connect to analogue jacks

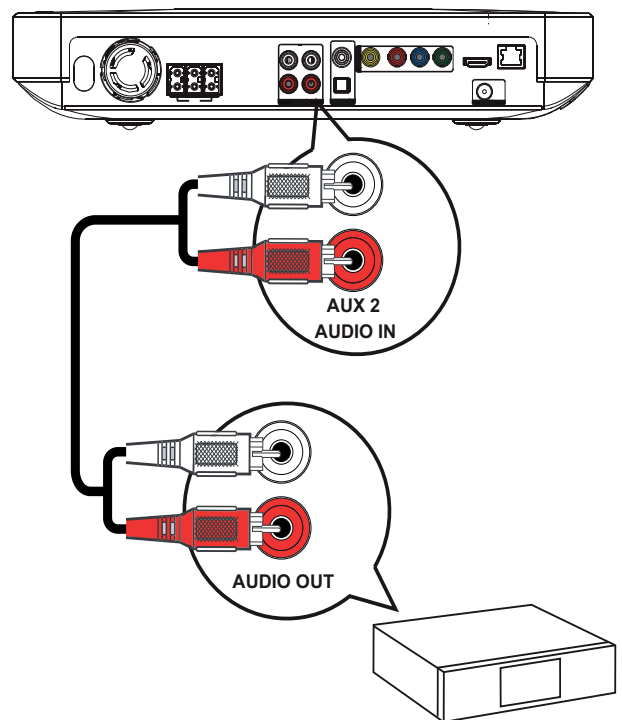

- 1 Connect the audio cables (not supplied) to the **AUDIO IN-AUX2** jacks on this Home Theatre System and the AUDIO output jacks on the device.



### Note

- To listen to the audio output from this connection, press **AUDIO SOURCE** repeatedly until 'AUX2' is displayed on the display panel.

### Connect to coaxial jack

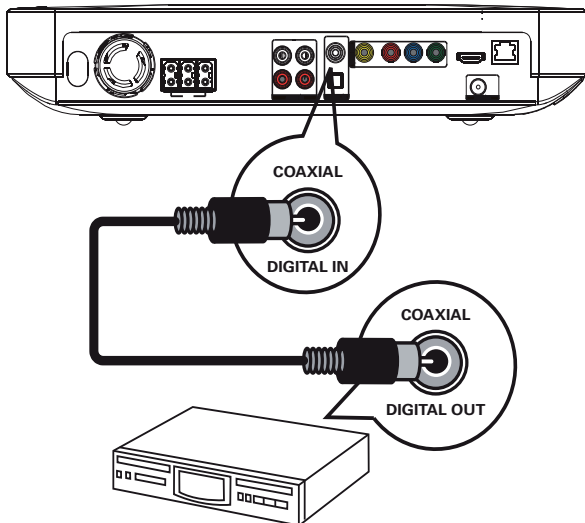

- 1 Connect a coaxial cable (not supplied) to the **DIGITAL-IN-COAXIAL** jack on this Home Theatre System and the **COAXIAL/DIGITAL** output jack on the device.



### Note

- To listen to the audio output from this connection, press **AUDIO SOURCE** repeatedly until 'COAX IN' is displayed on the display panel.

### Connect to optical jack

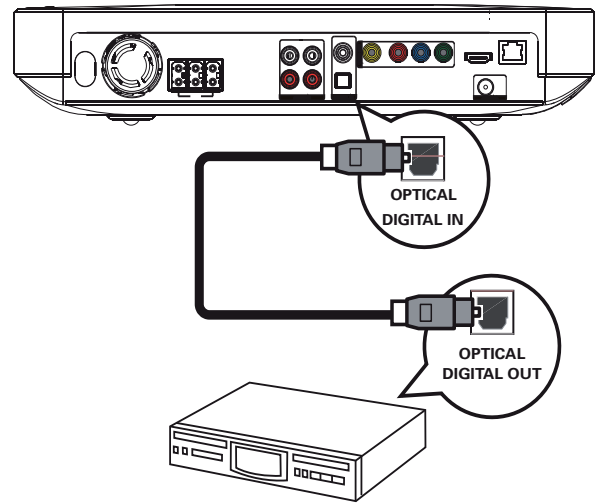

- 1 Connect an optical cable (not supplied) to the **DIGITAL-IN-OPTICAL** jack on this Home Theatre System and the **OPTICAL/SPDIF** output jack on the device.



### Note

- To listen to the audio output from this connection, press **AUDIO SOURCE** repeatedly until 'OPTI IN' is displayed on the display panel.

### Connect portable media player

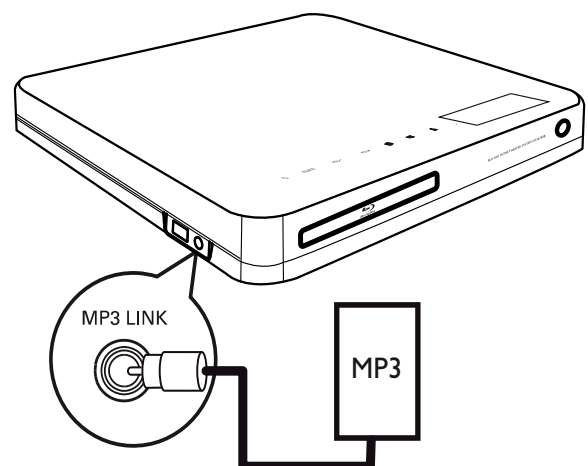



- 1 Connect a 3.5 mm stereo audio cable (not supplied) to the **MP3 LINK** jack on this Home Theatre System and the phone jack on the portable media player (such as MP3 player).

#### Note

- To listen to the audio output from this connection, press **AUDIO SOURCE** repeatedly until 'MP3 LINK' is displayed on the display panel.

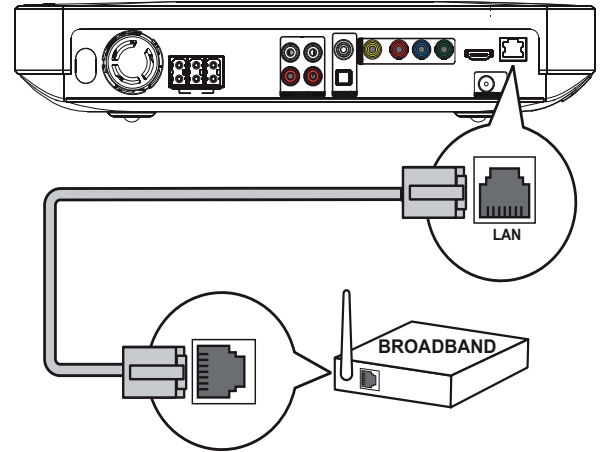

## Connect USB device

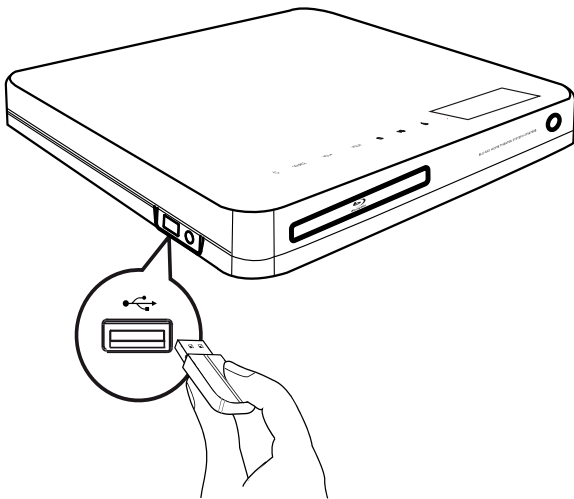

- 1 Connect the USB device to the **USB** jack on this Home Theatre System.

#### Note

- This Home Theatre System can only play/view MP3, WMA, DivX (Ultra) or JPEG files that are stored on such devices.
- Press **USB** to access the content and play the files.

## Connect LAN

Connect this Home Theatre System to the network for software updates and enjoy BD-Live applications.

- 1 Connect the network cable (not supplied) to the **LAN** jack on this Home Theatre System and the LAN jack on the broadband modem or router.

#### Note

- Use an RJ45 straight cable. Do not use a crossover cable.
- Internet access to Philips website for software updates may not be allowed, depending on the router you use or the Internet Service Provider's policy. Contact your Internet Service Provider for more information.

## Connect power cord

#### Warning

- Risk of product damage! Ensure that the power supply voltage corresponds to the voltage printed on the back or the underside of the product.

- 1 Connect the power cord to the socket when all the required connections are made.  
↳ This product is ready to be set up for use.

## 4 Get started

### Insert the remote control batteries

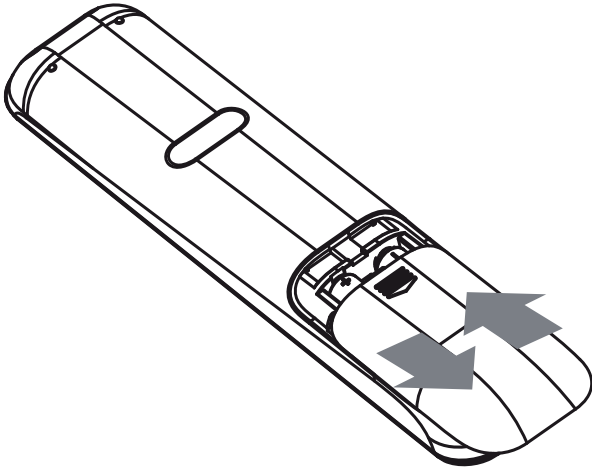

- 1 On the back of the remote control, slide the battery cover to remove it.
- 2 Insert the 2 supplied batteries (AAA). Be sure the + and - ends of the batteries line up with the markings inside the case.
- 3 Slide the cover back into position.

#### Note

- Do not mix batteries (old and new or carbon and alkaline, etc.).
- Remove batteries if they are exhausted or if the remote control is not to be used for a long time.
- Batteries contain chemical substances, they should be disposed of properly.

### Navigate through the menu

- 1 Point the remote control directly at the remote sensor on the product and select the desired function.
- 2 Press the following buttons on the remote control to navigate through the on-screen menus.

Button	Action
▲▼	Move up or down
◀▶	Move left or right
OK	Confirm a selection
1 2 3	Enter numbers
4 5 6	
7 8 9	
0	
🏠	Access to the Home menu.

### Find the correct viewing channel

- 1 Press **⏻ (Standby)** to turn on this product.
- 2 Press **DISC** to switch to disc mode.
- 3 Turn on the TV and switch to the correct video-in channel in one of the following ways:
  - Go to the lowest channel on your TV, then press the Channel Down button until you see the Philips or the Home menu screen.
  - Press the **SOURCE** button repeatedly on the remote control of your TV.

#### Tip

- The video-in channel is between the lowest and highest channels and may be called FRONT, A/V IN, VIDEO, HDMI etc. See the TV user manual on how to select the correct input on the TV.

## Use the Home menu



Press **⬆** (Home menu).

- Select **[Play Disc]** to start disc play.
- Select **[USB]** to view the USB contents.
- Select **[Settings]** to access the setup menu.

## Select menu display language

### Note

- Skip this setting if this product is connected to a HDMI CEC compliant TV. It switches automatically to the same OSD menu language as per your TV setting.

- 1 In the Home menu, select **[Settings]** and press **OK**.
- 2 Select **[Preference Setup]**, then press **▶**.
- 3 Select **[OSD Language]**, then press **OK**.

OSD Language	English
Parental Control	Français
Screen Saver	Deutsch
Change PIN	Italiano
Display Panel	Español
Auto Standby	Nederlands
PBC	Svenska
Sleep Timer	Português

- The language options are different depending on your country or region. It may not correspond to the illustration shown here.

- 4 Press **▲▼** to select a language, then press **OK**.

### Tip

- You can set the default language for DVD disc, see ('Adjust settings' > 'Video Setup' > **[Disc Menu]**).

## Set up network

Follow the steps below to help you set up the network connection for software updates and enjoy BD-Live applications.

- 1 Connect the home theatre to a broadband modem or router.
- 2 Turn on your TV and switch to the correct source for the home theatre.
- 3 Press **⬆**, select **[Settings]**, and then press **OK**.
- 4 Select **[Advanced Setup]** > **[Network]** > **[Next]**.
- 5 Press **OK**.  
↳ The home theatre connects to the Internet. If connection fails, select **[Retry]**, then press **OK**.
- 6 Select **[Finish]**, then press **OK** to exit.

### Note

- Loading BD-Live content from the Internet may take some time, depending on the file size and the speed of the Internet connection.

## Use Philips EasyLink

Your product supports Philips EasyLink, which uses the HDMI CEC (Consumer Electronics Control) protocol. EasyLink-compliant devices that are connected through HDMI connectors can be controlled by a single remote control.

### Note

- Philips does not guarantee 100% interoperability with all HDMI CEC devices.

- 1 Turn on the HDMI CEC operations on the TV and other connected devices. See TVs/devices manual for details.
- 2 You can now enjoy the following Philips EasyLink controls.

### EasyLink

Turn off or turn on all EasyLink features.

### One-touch play

When you press **PLAY** on the remote control, the TV (if it supports one-touch play) and the Home Theatre System will be turned on. Disc play starts if there is a disc in the Home Theatre System and the TV automatically switches to the correct channel to show the video content.

### One-touch standby

When you press and hold **Standby** on the remote control, this Home Theatre System and all the connected HDMI CEC devices (if they support one-touch standby) switch to standby mode simultaneously.

### System Audio Control

When you play a device where the audio output is routed to this Home Theatre System, this Home Theatre System switches to the corresponding audio source automatically.

To use one-touch audio, map the connected devices correctly to the audio input jacks of this Home Theatre System.

## Audio Input Mapping

When you map the connection between other devices and the audio input jacks of this Home Theatre System, you can enjoy the System Audio Control (one-touch audio) feature.

## Map the devices to the audio inputs

### Note

- Before you start, ensure that the audio output of the HDMI TV and other HDMI devices have been connected to the audio input jacks on this Home Theatre System.

Video Setup	EasyLink	● On
Audio Setup	One Touch Play	● On
Preference Setup	One Touch Standby	● On
EasyLink Setup	System Audio Control	● Off
Advanced Setup	Audio Input Mapping	●

- 1 Press **Home**, select **[Settings]**, then press **OK**.
- 2 Select **[EasyLink Setup]**, then press **Right**.
  - **[One Touch Play]** and **[One Touch Standby]** functions are turned on by default.
- 3 Select **[System Audio Control] > [On]**.
- 4 Read the on-screen instructions and press **OK** to select **[Continue]**.
  - ↳ The Home Theatre System scans and displays the valid devices.
- 5 Press **OK** to select **[Continue]**.

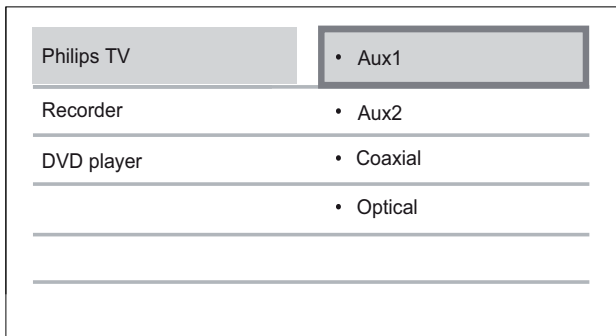

- 6 Select a connected device on the left of the menu, then press ►.
- 7 Select the connector that is used for the device, then press **OK**.
  - ↳ Repeat steps 6–7 to map other devices.
- 8 Press **▲** to exit the menu.

---

## Update audio mapping from connected devices

If you have already mapped audio from connected devices, you can use this procedure to update your mapping.

- 1 Press **▲**, select **[Settings]**, then press **OK**.
- 2 Select **[EasyLink Setup] > [Audio Input Mapping]**, then press **OK**.
- 3 Select a connected device, then press ►.
- 4 Select the connector that is used for the device then press **OK**.
- 5 Repeat the steps 4–5 to map other connected devices.

# 5 Play

## Play a disc



### Caution

- Never place any objects other than discs into the disc compartment.
- Never touch the disc optical lens inside the disc compartment.

- 1 Press **▲** to open the disc compartment.
- 2 Insert a disc with its label facing up.
  - For a double-sided disc, load the side to play facing up.
- 3 Press **▲** to close the disc compartment and start disc play.
  - To view disc play, turn on the TV to the correct viewing channel for this Home Theatre System.
  - To stop disc play, press **■**.



### Note

- Check the types of discs supported, (see 'Specifications' > 'Playback media').
- If the password entry menu is displayed, enter the password before you can play the locked or restricted disc (see 'Adjust settings' > 'Preference Setup' > **[Parental Control]**).
- If you pause or stop a disc, the screen saver appears after 10 minutes of inactivity. To deactivate the screen saver, press any buttons.
- After you pause or stop a disc and no buttons are pressed within 30 minutes, this product automatically switches to standby mode.

## Information on disc contents

The contents of a disc are generally divided into sections or folders (groups of titles/files) as shown below.

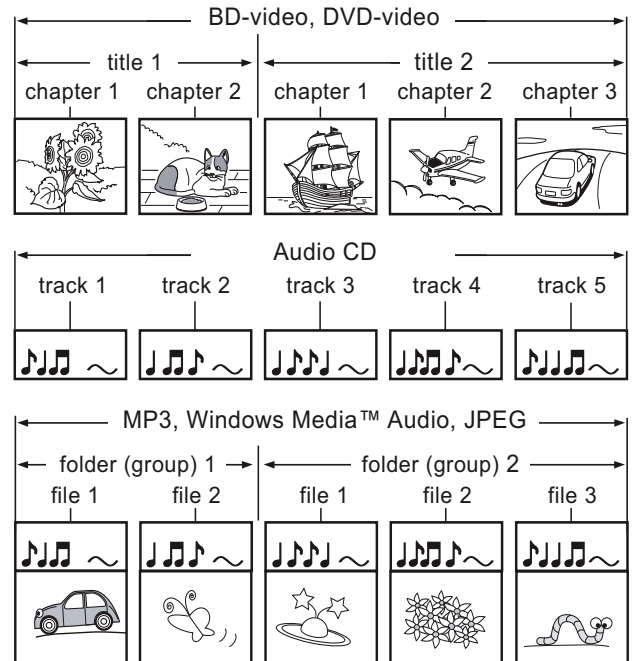

- 'Folders' refers to the groups of files.
- 'Tracks' refers to the contents recorded on the audio CD.
- 'Files' refers to the contents on a disc which are recorded in MP3, Windows Media™ Audio/Video or JPEG file format.

---

## Play video

---

### Control video play

- 1 Play a title.
- 2 Use the remote control to control the title.

Button	Action
⏸	Pauses play.
▶(Play)	Starts or resumes play.
■	Stops play. <ul style="list-style-type: none"><li>• Home menu is displayed.</li></ul>
▶	Skips to the next title or chapter.
◀	Skips to the beginning of the current title or chapter. Press twice to jump to the previous title or chapter.
◀◀ / ▶▶	Searches fast-forward (right) or fast-backward (left). Press repeatedly to change the search speed. <ul style="list-style-type: none"><li>• In pause mode, slow motion backwards or forwards play.</li></ul>



#### Note

- Disc play always resumes from the point where it was last stopped. To start play from the beginning, press **OK** while the message is displayed.
- For BD disc with Java application, the resume function is not available.

---

## Change video play

- 1 Play a title.
- 2 Use the remote control to change the video play.

Button	Action
AUDIO	Selects an audio language or channel.
SUBTITLE	Selects a subtitle language for video.
REPEAT	Selects or turns off repeat or shuffle mode. <ul style="list-style-type: none"><li>• Repeat options vary depending on the disc type.</li><li>• For VCDs, repeat play is only possible when the PBC mode is turned off.</li></ul>
 INFO	Displays the current status or the disc information.
 OPTIONS	Accesses options for the current activity or selection. <ul style="list-style-type: none"><li>• Change the play options here without interrupting disc play. For example, Zoom, Time Search.</li></ul>
BONUS VIEW	Turns on or off the secondary video in a small screen window during play (applicable only to BD-video that supports the BONUSVIEW or Picture-In-Picture feature).

#### Note

- Some operations may not work with some discs. See the information accompanying the disc for details.

## Display menu

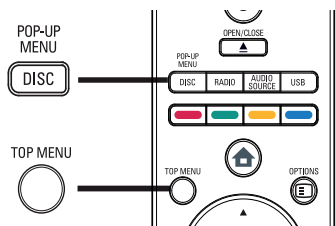

### BD-video disc

- **TOP MENU** stops the video play and shows the disc menu. This feature is disc-dependent.
- **POP-UP MENU** accesses the BD-video disc menu without interrupting disc play.

### DVD-video disc

- **DISC MENU** displays disc information and guides you through the available functions in the disc.
- **TOP MENU** displays the contents in the disc.

### VCD/SVCD disc:

- **DISC MENU** displays the content of the disc.



#### Tip

- If the PBC setting is off, the VCD/SVCD skips the menu and starts playing from the first title. To display the menu before play, turn on the PBC setting (see chapter 'Adjust settings' > 'Preference Setup' > [PBC]).

## Select title/chapter

- 1 During play, press **OPTIONS**.  
↳ The play options menu is displayed.
- 2 Select [**Titles**] or [**Chapters**] in the menu, then press **OK**.
- 3 Select the title or chapter number, then press **OK**.

## Quick skip to a specific time

- 1 During play, press **OPTIONS**.  
↳ The play options menu is displayed.
- 2 Select [**Time Search**] in the menu, then press **OK**.
- 3 Press the **Numeric buttons** to change the time where you want to skip to, then press **OK**.

## Zoom in/out

- 1 During play, press **OPTIONS**.  
↳ The play options menu is displayed.
- 2 Select [**Zoom**] in the menu, then press **OK**.
- 3 Press the **Navigation buttons** ( ) to select a zoom factor, then press **OK**.
- 4 Press the **Navigation buttons** to pan through the zoomed picture.
  - To cancel zoom mode, press **BACK** to display the zoom factor bar, then press repeatedly until zoom factor [X1] is selected.

## Repeat play for a specific section

- 1 During play, press **OPTIONS**.  
↳ The play options menu is displayed.
- 2 Select [**Repeat A-B**] in the menu, then press **OK** to set the starting point.
- 3 Forward the video play, then press **OK** to set the ending point.  
↳ Repeat play starts.
  - To cancel repeat play mode, press **OPTIONS**, select [**Repeat A-B**] and press **OK**.



#### Note

- The marked section for repeat play is only possible within a track/title.



## View video play from different camera angles

- 1 During play, press **OPTION**.  
↳ The play options menu is displayed.
- 2 Select **[Angle List]** in the menu, then press **OK**.
- 3 Select an angle option, then press **OK**.  
↳ Play changes to the selected angle.

### Note

- Applicable only to discs that contain multi-angle scenes.

## Sync audio output with video play

If the video play is slower than the audio output (the sound does not match with the pictures), you can delay the audio output to match the video.

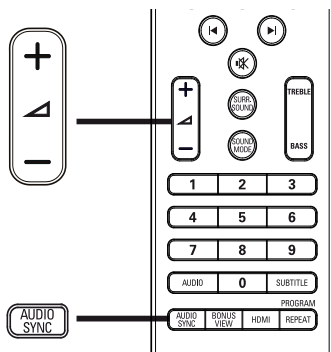

- 1 Press **AUDIO SYNC**.  
↳ 'AUDIO SYNC' is displayed.
- 2 Within five seconds, press **+/-** to set the delay time for audio output.

### Note

- If the volume control is not used within five seconds, it resumes normal volume control function.

## Play BD-video

Blu-ray video disc has a larger capacity and supports features such as high-definition videos, multi-channel surround sound, interactive menus and so on.

- 1 Insert a BD-video disc.
- 2 Press **HOME**, select **[Play Disc]** and press **OK**.
- 3 Play start automatically or select a play option in the menu and press **OK**.
  - During play, you can press **TOP MENU** to display additional information, features or content stored in the disc.
  - During play, you can press **POP-UP MENU** to display the disc menu without interrupting disc play.

## Enjoy BONUSVIEW

Blu-ray discs that support the Bonus View feature (also known as Picture-In-Picture) allow you to view special content, such as a director's commentary, while watching the main feature.



- (A) Primary video
- (B) Secondary video

- 1 Press **BONUS VIEW** to turn on the secondary video window.
- 2 Press **OPTION**.  
↳ The play options menu is displayed.
- 3 Select **[2nd Audio Language]** or **[2nd Subtitle Language]** in the menu, then press **▶**.

- 4 Select the language to play, then press **OK**.

### Enjoy BD-LIVE

(applicable only to BD Live enabled BD-Video)  
Additional content such as movie trailers, subtitles, etc. can be downloaded to the external storage (USB) on this Home Theatre System. Special video data may be played back while they are being downloaded. When the disc supporting BD-Live is played back, the Home Theatre System or disc's ID can be sent to the content provider via the Internet. Services and functions to be provided differ depending on the disc.

#### Note

- Use a USB device with at least 1 GB of free space to store the downloaded files.

### Play DivX® video

DivX video is a digital media format that retains high quality despite a high rate of compression. You can enjoy DivX video on the certified product.

- 1 Insert a disc or USB that contains the DivX videos.
- 2 Press **HOME**, select **[Play Disc]** or **[USB]**, then press **OK**.  
↳ A contents menu is displayed.
- 3 Select a title to play, then press **▶(Play)**.
- 4 Use the remote control to control the video play.

Button	Action
<b>AUDIO</b>	Selects an audio language or channel.
<b>SUBTITLE</b>	Selects a subtitle language for video.
<b>■</b>	Stops play. <ul style="list-style-type: none"> <li>• For DivX Ultra video, press this button again to display the contents menu.</li> </ul>

#### Note

- You can only play DivX videos that were rented or purchased with the DivX registration code of this player (see 'Adjust Settings' > 'Advanced Setup' > **[DivX® VOD Code]**).
- You can play DivX video files of up to 4 GB.

## Play music

### Control a track

- 1 Play a track.
- 2 Use the remote control to control the track.

Button	Action
<b>  </b>	Pauses play.
<b>▶(Play)</b>	Starts or resumes play.
<b>■</b>	Stops play.
<b>▶</b>	Skips to the next track.
<b>◀</b>	Skips to the beginning of the current track. Press twice to jump to the previous track.
<b>1 2 3</b> <b>4 5 6</b> <b>7 8 9</b> <b>0</b>	Selects an item to play.
<b>◀◀ / ▶▶</b>	Searches fast-forward (right) or fast-backward (left). Press repeatedly to change the search speed.
<b>REPEAT</b>	Selects or turns off repeat or shuffle mode.

#### Note

- For some commercial audio discs, disc play always resumes from the point where it was last stopped. To start play from the first track, press **OK**.

---

## Play MP3/WMA music

MP3/WMA is a type of highly compressed audio file (files with .mp3, .wma extensions).

- 1 Insert a disc or USB that contains the MP3/WMA music.
- 2 Press **▲**, select **[Play Disc]** or **[USB]**, then press **OK**.  
↳ A contents menu is displayed.
- 3 Select a folder, then press **OK**.
- 4 Select a track to play, then press **▶(Play)**.
  - To return to the main menu, press **↶ BACK**.

### Note

- For a disc recorded in multiple sessions, only the first session is played.
- This product does not support MP3PRO audio format.
- If any special characters are present in the MP3 track name (ID3) or album name, it might not be displayed correctly on the screen because these characters are not supported.
- Some WMA files are protected by Digital Rights Management (DRM), it cannot be played on this product.
- Folders/files that exceed the supported limit of this product will not be displayed or played.

---

## Play photo

---

### Play photo as slideshow

You can play JPEG photos (files with .jpeg or .jpg extensions).

- 1 Insert a disc or USB that contains the JPEG photos.
- 2 Press **▲**, select **[Play Disc]** or **[USB]**, then press **OK**.  
↳ A contents menu is displayed.
- 3 Select the folder/album you want to play.
  - To select a photo, press the **Navigation buttons**.
  - To display the selected photo and start slideshows, press **OK**.
- 4 Press **▶(Play)** to start slideshow play.

### Note

- You may require more time to display the disc content on the TV due to the large number of songs/photos compiled onto one disc/USB device.
- This product can only display digital camera pictures according to the JPEG-EXIF format, typically used by almost all digital cameras. It cannot display Motion JPEG and pictures in formats other than JPEG or sound clips associated with pictures.
- Folders/files that exceed the supported limit of this product will not be displayed or played.

## Control photo play

- 1 Play photo slideshow.
- 2 Use the remote control to control the photo.

Button	Action
◀	Rotates the photo anti-clockwise.
▶	Rotates the photo clockwise.
▲	Flips the photo upside down.
▼	Flips the photo left-to-right (mirror image).
■	Stops play.
☰ <b>OPTIONS</b>	Accesses options for the current activity or selection. For example, Zoom.

### Note

- Some operations may not work with some discs or files.

## Set slideshow interval and animation

- 1 During play, press ☰ **OPTIONS**.  
↳ The play options menu is displayed.
- 2 Select **[Duration per slide]** in the menu, then press **OK**.
- 3 Select the duration per slide, then press **OK**.
- 4 Select **[Slide Animation]** in the menu, then press **OK**.
- 5 Select the type of slide animation effect you want to apply, then press **OK**.

## Play musical slideshow

Play MP3/WMA music files and JPEG photo files simultaneously to create musical slideshow. The MP3/WMA and JPEG files must be stored on the same disc or USB device.





- 1 Play MP3/WMA music.
- 2 Press ↩ **BACK** to return to the main menu.
- 3 Navigate to the photo folder/album and press **OK** to start slideshow play.
  - ↳ Slideshow begins and continues till the end of the photo folder or album.
  - ↳ Audio continues to play until the end of the disc.
    - To stop slideshow play, press ■.
    - To stop music play, press ■ again.

## Play from USB device

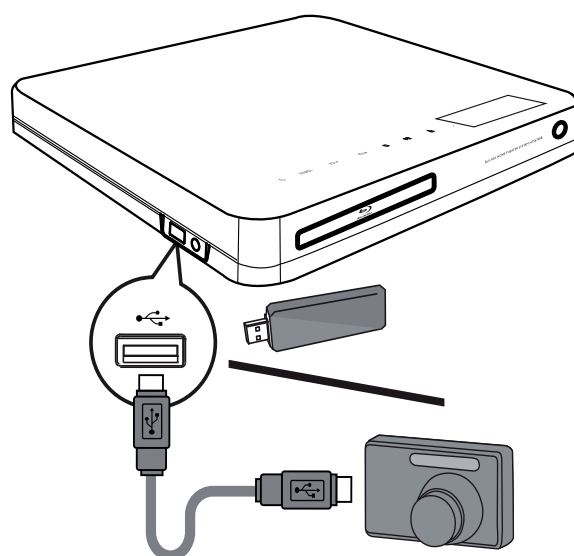
Play or view MP3, WMA/WMV, DivX (Ultra) or JPEG files on the following USB devices:

- flash drive
- memory card reader
- HDD (external power source needed)
- Digital camera



- 1 Connect a USB device to the  **USB** jack.
- 2 Press , select **[USB]**, then press **OK**.  
↳ A contents menu is displayed.
- 3 Select a file to play, then press  (**Play**).  
↳ Play starts (see 'Play music, Play photo, Play video' for details).
  - To stop play, press  or remove the USB device.

#### Note

- If the device does not fit into the USB jack, connect it through a USB extension cable.
- Not all digital cameras are supported. Digital cameras that require PC program installation are not supported.
- NTFS (New Technology File System) data format not supported.

## Play from portable media player

Simply connect your portable media player (e.g. MP3 player) to this Home Theatre System to enjoy superb sound quality from your music collections.

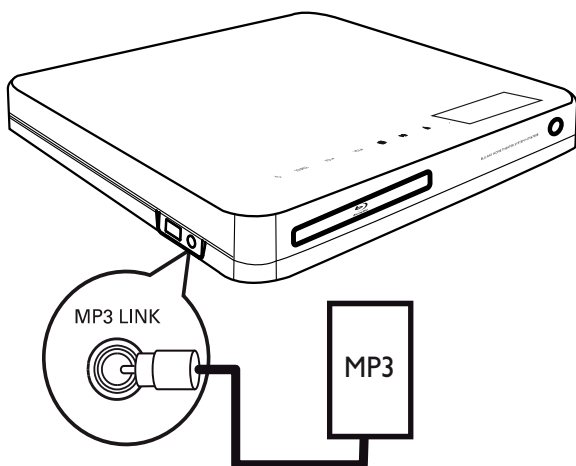

- 1 Connect a 3.5 mm stereo audio cable (not supplied) from the **MP3 LINK** jack on this Home Theatre System to the 'headphone' jack on the portable media player.
- 2 Press **AUDIO SOURCE** repeatedly until 'MP3 LINK' is displayed.
- 3 Start play on your portable media player.
  - To stop play, press **STOP** on the portable media player.

#### Note

- Control playback is only possible on the portable media player.
- Stop play on the portable media player before you switch to other play media/source.

## Play from radio

Check that the FM antenna has been connected to this Home Theatre System. If not, connect the supplied FM antenna to the **FM75 Ω** jack and fix its ends to the wall.

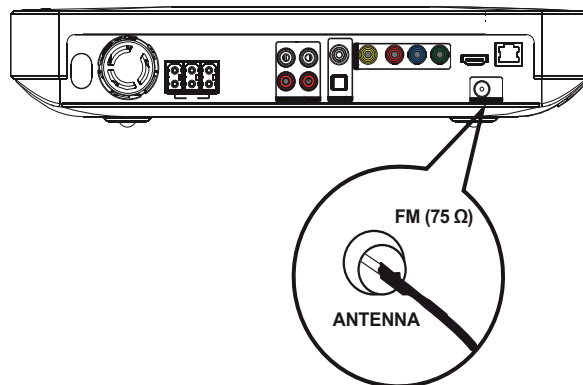

#### Tip

- For the best reception, place the antenna away from your TV and other sources of radiation.
- For even better reception of FM stereo, connect an external FM antenna (not supplied).

## First time tuning

When you access radio mode for the first time, follow the instruction to install the radio stations.

- 1 Press **RADIO**.
  - ↳ 'AUTO INSTALL ... PRESS PLAY' is displayed.
- 2 Press **▶(Play)**.
  - ↳ All detected radio stations are stored.
  - ↳ Once complete, it tunes to the first preset radio station.
    - To stop auto tuning, press **■**.

### Note

- This Home Theatre System can store up to a maximum of 40 radio stations.
- If auto installation is not activated or less than 5 radio stations are stored, you will be prompted to install the radio stations again.

## Listen to radio

- 1 Press **RADIO**.
- 2 Use the remote control to control the radio.

Button	Action
<b>◀▶</b>	Selects a preset radio station.
<b>▲▼</b>	Tunes the radio frequency up or down.
<b>■</b>	Press and hold this button to erase the current radio station from the preset list. <ul style="list-style-type: none"> <li>• The preset number for other radio stations remain unchanged.</li> </ul>

### Note

- If the FM radio station transmits RDS (Radio Data System) data, the name of the radio station is displayed.

## Reinstall all the radio stations

- 1 Press **RADIO**.
- 2 Press and hold **PROGRAM** for more than 5 seconds.
  - ↳ All previously stored radio stations are replaced.

### Note

- Check the radio antenna connection if no stereo signal is detected or less than 5 stations are detected during radio installation.

## Search and store radio stations individually

- 1 Press **RADIO**.
- 2 Press **◀ / ▶**.
  - ↳ It starts searching until a radio station is detected.
- 3 Repeat step 2 until you tune to the radio station you wish to store.
  - To fine tune the radio frequency, press **▲ / ▼**.
- 4 Press **PROGRAM**.
  - ↳ The preset station number blinks.
  - ↳ If no action is carried out within 20 seconds after the above step, it exits the preset mode.
- 5 Press **◀ / ▶** (or the **Numeric buttons**) to select a preset number to store.
- 6 Press **PROGRAM** to confirm.

# 6 Adjust sound

## Control the volume

- 1 Press  $\triangleleft$  +/- to increase or decrease the volume.
  - To mute, press  $\text{M}$ .
  - To restore the volume, press  $\text{M}$  again or press  $\triangleleft$  +.

## Change treble and bass

Change the high frequency (treble) or low frequency (bass) settings of the Home Theatre System to suit your video or music.

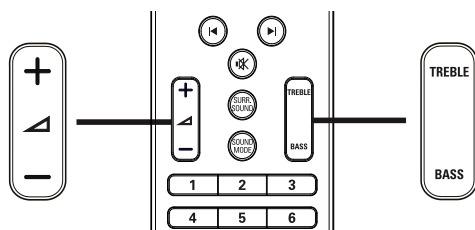

- 1 Press **TREBLE** or **BASS**.
- 2 Within five seconds, press  $\triangleleft$  +/- to increase or decrease treble or bass.

## Select surround sound

Experience an immersive audio experience with surround sound modes.

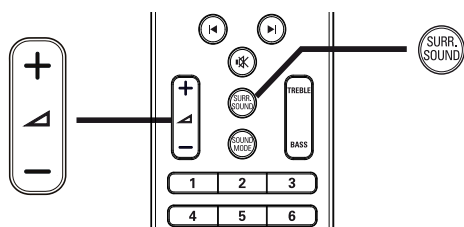

- 1 Press **SURR. SOUND** repeatedly to select the virtual speaker or stereo sound.

Option	Description
DOLBY VS	Dolby Virtual surround sound
STEREO	Stereo sound from two front speakers.

### Note

- This product also contains the capability to decode 5.1 DTS-Digital Surround.

## Select preset sound

Select predefined sound modes to suit your video or music.

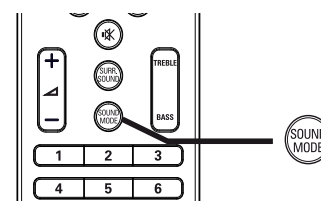

- 1 Press **SOUND MODE** repeatedly to cycle through the available sound modes.

Sound mode	Description
<b>ACTION / ROCK</b>	Enhanced low and high-range. Ideal for action movies and rock or pop music.
<b>DRAMA / JAZZ</b>	Clear mid and high-range. Ideal for drama movies and jazz music.
<b>CONCERT/ CLASSIC</b>	Neutral sound. Ideal for live concerts and classical music.
<b>SPORTS</b>	Moderate mid-range and surround effects for clear vocals and the atmosphere of a live sport venue.

# 7 Adjust settings

You can customise various kinds of settings as you prefer. Refer to the following instructions to navigate through the setup menus.

## Note

- You cannot change a setting that is greyed out.

## Video Setup

- Press **⬆**.
- Select **[Settings]**, then press **OK**.
- Select **[Video Setup]**, then press **▶**.

Video Setup	Audio	● English
Audio Setup	Subtitle	● Off
Preference Setup	Disc Menu	● English
EasyLink Setup	TV Display	● 16:9 Widescreen
Advanced Setup	HDMI Video	● Auto
	HDMI Deep Color	● Auto
	Component Video	● 480i/576i
	Picture Settings	● Standard

- Select an option, then press **OK**.
- Select a setting, then press **OK**.
  - To return to the previous menu, press **↩ BACK**.
  - To exit the menu, press **⬆**.

## Note

- See the explanations of the above options in the following pages.

### [Audio]

Selects the default audio language for disc play.

### [Subtitle]

Selects the default subtitle language for disc play.

### [Disc Menu]

Selects the language for the disc menu.

## Note

- If the language you have set is not available on the disc, the disc uses its own default language.
- For some discs, the subtitle/audio language can only be changed from the disc menu.

### [TV Display]

Selects one of the following display formats which the disc can support.



4:3 Pan Scan (PS)      4:3 Letter Box (LB)      16:9 (Wide Screen)

- [4:3 Panscan]** – For 4:3 screen TV: full-height display with the trimmed sides.
- [4:3 Letterbox]** – For 4:3 screen TV: wide-screen display with black bars on the top and bottom of the screen.
- [16:9 Widescreen]** – For wide-screen TV: display ratio 16:9.

### [HDMI Video]

Selects the HDMI video output resolution that is compatible with your TV display capability.

- [Auto]** - Detects and selects the best supported video resolution automatically.
- [Native]** - Sets to original video resolution.
- [480i/576i], [480p/576p], [720p], [1080i], [1080p], [1080p/24Hz]** - Selects a video resolution setting that is best supported by the TV. See the TV manual for details.



### Note

- If the setting is not compatible with your TV, a blank screen appears. Wait for 15 seconds for auto recover or press **HDMI** repeatedly until the picture appears.

### [HDMI Deep Colour]

This feature is available only when the display device is connected by a HDMI cable, and when it supports the deep colour feature.

- **[Auto]** - Switches on automatically if the connected display device supports HDMI deep colour.
- **[On]** - Enjoys vivid images in over a billion colours on Deep Colour enabled TV. Outputs 12 bit colour that reduces the posterisation effect.
- **[Off]** - Outputs standard 8 bit colour.

### [Component Video]

Selects the Component video output resolution that is compatible with the TV display capability.

- **[480i/576i], [480p/576p], [720p], [1080i]**  
- Selects a video resolution setting that is best supported by the TV. See the TV manual for details.

### Note

- If the setting is not compatible with the TV, a blank screen appears. Wait for 15 seconds for auto recovery.

### [Picture Settings]

Selects a predefined set of picture colour settings.

- **[Standard]** – Original colour setting.
- **[Vivid]** – Vibrant colour setting.
- **[Cool]** - Soft colour setting.
- **[Action]** – Sharp colour setting. It enhances the details in the dark areas. Ideal for action movies.
- **[Animation]** – Contrast colour setting. Ideal for animated pictures.

### [Black Level]

Improves black colour contrast.

- **[Normal]** - Standard black level.
- **[Enhanced]** - Enhances black level.

---

## Audio Setup

- 1 Press **▲**.
- 2 Select **[Settings]**, then press **OK**.
- 3 Select **[Audio Setup]**, then press **▶**.

Video Setup	Night Mode	● Off
<b>Audio Setup</b>	HDMI Audio	● Auto
Preference Setup		
EasyLink Setup		
Advanced Setup		

- 4 Select an option, then press **OK**.
- 5 Select a setting, then press **OK**.
  - To return to the previous menu, press **↶ BACK**.
  - To exit the menu, press **▲**.

### Note

- See the explanations of the above options in the following pages.

### [Night Mode]

Makes the loud sound level softer and the soft sound level louder so that you can watch the disc at a low volume, without disturbing others.

- **[On]** – For quiet viewing at night.
- **[Off]** – For surround sound with a full dynamic range.



#### Note

- Applicable only to Dolby encoded DVD-video or BD-video.

### [HDMI Audio]

Selects the HDMI audio output when you connect this Home Theatre System and the TV/audio device with a HDMI cable.

- **[As Source]**– The audio format is not converted. A secondary audio track on a Blu-ray disc might not be available.
- **[Auto]** – Detects and selects the best supported audio format automatically.
- **[Off]** - Disables audio from the TV.

## Preference Setup

- 1 Press **⬆**.
- 2 Select **[Settings]**, then press **OK**.
- 3 Select **[Preference Setup]**, then press **▶**.

Video Setup	OSD Language	● English
Audio Setup	Parental Control	● Off
<b>Preference Setup</b>	Screen Saver	● On
EasyLink Setup	Change PIN	●
Advanced Setup	Display Panel	● 100%
	Auto Standby	● On
	PBC	● On
	Sleep Timer	● Off

- 4 Select an option, then press **OK**.
- 5 Select a setting, then press **OK**.
  - To return to the previous menu, press **↶ BACK**.
  - To exit the menu, press **⬆**.



#### Note

- See the explanations of the above options in the following pages.

### [OSD Language]

Selects the default on-screen menu language.



#### Note

- If this product is connected to a HDMI CEC compliant TV using a HDMI cable, it switches automatically to the same menu display language as per your TV setting.

### [Parental Control]

Restricts access to discs that are unsuitable for children. These types of discs must be recorded with ratings.

To access, enter your last set password or '0000' using the keyboard on the TV.

#### Note

- Rated discs above the level you set in **[Parental Control]** require a password to be played.
- The ratings are country-dependent. To allow all discs to play, select '8' for DVD-video and BD-Video.
- Some discs have ratings printed on them but are not recorded with ratings. This function has no effect on such discs.

### [Screen Saver]

Turns off or on the screen saver mode. Helps to protect the TV screen from being damaged due to over exposure to a static image for too long.

- **[On]** - Sets the screen saver to appear after 10 mins of inactivity (for example, in pause or stop mode)
- **[Off]** - Disables screen saver mode.

### [Change PIN]

Sets or changes the password.

- 1) Press the **Numeric buttons** to enter the password or your last set password. If you forget the password, enter '0000', then press **OK**.
- 2) Enter the new password.
- 3) Enter the same password again.
- 4) Move to **[Confirm]** in the menu and press **OK**.

### [Display Panel]

Selects the brightness level of the front panel display.

- **[100%]** - Brightest
- **[70%]** - Medium
- **[40%]** - Dimmest

### [Auto Standby]

Turns off or turns on standby switching mode. It is an energy saving feature.

- **[On]** - Switches to standby after 30 minutes of inactivity (for example, in pause or stop mode).
- **[Off]** - Disables auto standby mode.

### [PBC]

Turns off or on the content menu of VCDs/ SVCDs with PBC (playback control) feature.

- **[On]** - Displays the index menu when you load a disc to play.
- **[Off]** - Skips the menu and starts play from the first title.

### [Sleep Timer]

Switches to standby automatically after a delay.

- **[Off]** - Disables the sleep timer.
- **[15 Minutes], [30 Minutes], [45 Minutes], [60 Minutes]** - Selects a delay.

---

## EasyLink Setup

- 1 Press **▲**.
- 2 Select **[Settings]**, then press **OK**.
- 3 Select **[EasyLink Setup]**, then press **▶**.

Video Setup	EasyLink	● On
Audio Setup	One Touch Play	● On
Preference Setup	One Touch Standby	● On
<b>EasyLink Setup</b>	System Audio Control	● Off
Advanced Setup	Audio Input Mapping	●

- 4 Select an option, then press **OK**.
- 5 Select a setting, then press **OK**.
  - To return to the previous menu, press **↩ BACK**.
  - To exit the menu, press **▲**.

 Note

- See the explanations of the above options in the following pages.

### [EasyLink]

Your product supports Philips Easylink, which uses the HDMI CEC (Consumer Electronics Control) protocol. EasyLink-compliant devices that are connected through HDMI connectors can be controlled by a single remote control.

- **[On]** - Enables EasyLink features.
- **[Off]** - Disables EasyLink features.

### [One Touch Play]

When you press **PLAY** on the remote control, the TV (if it supports one-touch play) and the Home Theatre System will be turned on. Disc play starts if there is a disc in the Home Theatre System and the TV automatically switches to the correct channel to show the video content.

- **[On]** - Enables one-touch play feature.
- **[Off]** - Disables one-touch play feature.

### [One Touch Standby]

When you press and hold **⏻ (Standby)** on the remote control, this Home Theatre System and all the connected HDMI CEC devices (if they support one-touch standby) switch to standby mode simultaneously.

- **[On]** - Enables one-touch standby feature.
- **[Off]** - Disables one-touch standby feature.

 Note

- When **[Off]** is selected, the Home Theatre System cannot be switched to standby by a remote control from the TV or other devices.

### [System Audio Control]

When you play a device where the audio output is routed to this Home Theatre System, this Home Theatre System switches to the corresponding audio source automatically.

- **[On]** - Enables system audio control feature. Then proceed to **[Audio Input Mapping]** to scan and map all the connected devices.
- **[Off]** - Disables system audio control feature.

### [Audio Input Mapping]

Maps the connection between other devices and the audio input jacks of this Home Theatre System. Only the detected devices will be displayed for mapping.

 Note

- You need to enable the **[System Audio Control]** before you can map the audio input.

## Advanced Setup

- 1 Press **⬆**.
- 2 Select **[Settings]**, then press **OK**.
- 3 Select **[Advanced Setup]**, then press **▶**.

Video Setup	BD Live Security	● Off
Audio Setup	Network	●
Preference Setup	Software Download	●
EasyLink Setup	Clear Local Storage	●
Advanced Setup	DivX® VOD Code	●
	Version Info.	●
	Restore Factory Settings	●

- 4 Select an option, then press **OK**.
- 5 Select a setting, then press **OK**.
  - To return to the previous menu, press **↶ BACK**.
  - To exit the menu, press **⬆**.

 Note

- See the explanations of the above options in the following pages.

### [BD-Live Security]

You can restrict Internet access when BD-R/RE disc is used.

- **[On]** - Internet access is prohibited for all BD-Live contents.
- **[Off]** - Internet access is permitted for all BD-Live contents.

### [Network]

Sets up a connection to an external network for software download and BD-Live applications. It guides you through a step-by-step network installation procedure.

 Note

- There is more detailed description available, see 'Getting Started' > 'Set up network'.

### [Software Download]

Updates the software of this product (if a newer version is available on Philips website) to enhance playability.

- **[USB]** - Downloads software via USB.
- **[Network]** - Downloads software via network.

 Note

- There is more detailed description available, see 'Additional Information' > 'Upgrade Software'.

### [Clear Local Storage]

Deletes the content of the BD-Live storage folder on the USB drive.

 Note

- Local storage is a folder (BUDA) located on the connected USB device.

### [DivX® VOD Code]

Displays the DivX® registration code.

 Tip

- Enter this product's DivX registration code when you rent or purchase a video from [www.divx.com/vod](http://www.divx.com/vod). The DivX videos rented or purchased through the DivX® VOD (Video On Demand) service can be played only on the device to which it is registered.

### [Version Info.]

Displays the software version of this Home Theatre System.

 Tip

- This information is required when you want to find out if a newer software version is available at the Philips website that you may download and install on this Home Theatre System.

### [Restore Factory Settings]

Resets all the settings of this product to factory default, except for **[Parental Control]** setting.

## 8 Update software

To check for new updates, compare the current software version of your home theatre with the latest software version (if available) on the Philips website.

- 1 Press **⬆**.
- 2 Select **[Settings]**, then press **OK**.
- 3 Select **[Advanced Setup]** > **[Version Info.]**, then press **OK**.

---

### Update software via network

- 1 Prepare the network connection, see chapter 'Getting Started' > 'Set up network' for detailed information.
- 2 At Home menu, select **[Settings]** > **[Advanced Setup]** > **[Software Download]** > **[Network]**.
- 3 Follow the instructions on the TV to confirm update operation.
  - ↳ Once software update is complete, this Home Theatre System turns off to standby automatically.
- 4 Disconnect the power cord for a few seconds and connect again to reboot the Home Theatre System.

---

### Update software via USB

- 1 Go to the [www.philips.com/support](http://www.philips.com/support) to check the latest software version available for this Home Theatre System.
- 2 Create a folder named 'UPG' in the root of a USB flash drive.
- 3 Download the software onto the 'UPG' folder of the USB flash drive.
- 4 Unzip the downloaded software in the 'UPG' folder.
- 5 Insert the USB flash drive to this Home Theatre System.
- 6 At Home menu, select **[Settings]** > **[Advanced Setup]** > **[Software Download]** > **[USB]**.
- 7 Follow the instructions on the TV to confirm update operation.
  - ↳ Once software update is complete, this Home Theatre System turns off to standby automatically.
- 8 Disconnect the power cord for a few seconds and connect again to reboot the Home Theatre System.

#### Note

- Do not turn off the power or remove the USB when software updating is in progress as it may damage the Home Theatre System.

# 9 Specifications



## Note

- Specification and design are subject to change without notice

### Playback media

- BD-Video, BD-R, BD-RE, DVD-Video, DVD+R/+RW, DVD-R/-RW, DVD+R/-R DL, CD-R/CD-RW, Audio CD, Video CD/SVCD, Picture CD, MP3-CD, WMA-CD, DivX (Ultra)-CD, USB flash drive.

### Amplifier

- Total output power: 440 W RMS ( $\pm 0.5$  dB)
- Frequency response: 40 Hz – 20 kHz
- Signal-to-noise ratio: > 65 dB (A-weighted)
- Input sensitivity:
  - AUX 1/2: 400 +/-100 mV
  - MP3 LINK: 250 +/-100 mV

### Video

- Signal system: PAL/NTSC
- Component video output: 480i/576i, 480p/576p, 720p, 1080i
- HDMI output 480p, 576p, 720p, 1080i, 1080p, 1080p24

### Audio

- S/PDIF Digital audio input:
  - Coaxial: IEC 60958-3
  - Optical: TOSLINK
- Sampling frequency:
  - MP3: 32 kHz, 44.1 kHz, 48 kHz
  - WMA: 44.1 kHz, 48 kHz
- Constant bit rate:
  - MP3: 112 kbps - 320 kbps
  - WMA: 48 kbps - 192 kbps

### Radio

- Tuning range: FM 87.5-108 MHz (50 kHz)
- Signal-to-noise ratio: FM 50 dB
- Frequency response: FM 180 Hz – 9 kHz /  $\pm 6$ dB

### USB

- Compatibility: Hi-Speed USB (2.0)
- Class support: UMS (USB Mass Storage Class)
- File system: FAT16, FAT32

### Main Unit

- Power supply: 220-240V; ~50 Hz
- Power consumption: 100 W
- Standby power consumption: < 0.8 W
- Dimensions (WxHxD): 360 x 72 x 345 (mm)
- Weight: 4.2 kg

### Speakers

- System: full range satellite
- Speaker impedance: 4 ohm
- Speaker drivers: 2 x 3" woofer + 2" tweeter
- Frequency response: 150 Hz – 20 kHz
- Dimensions (WxHxD): 130 x 362 x 130 (mm)
- Weight: 1.8 kg

### Subwoofer

- Impedance: 3 ohm
- Speaker drivers: 165 mm (6.5") woofer
- Frequency response: 45 Hz – 5 kHz
- Dimensions (W x H x D): 295 x 375 x 295 (mm)
- Weight: 6.3 kg

### Laser Specification

- Laser Type:
  - BD Laser Diode: InGaN/AlGaIn
  - DVD Laser Diode: InGaAlP
  - CD Laser Diode: AlGaAs
- Wave length:
  - BD: 405 +5 nm/-5 nm
  - DVD: 650 +5nm/-10nm
  - CD: 790 +10nm/-20nm
- Output power:
  - BD: Max. ratings: 20 mW
  - DVD: Max. ratings: 7 mW
  - CD: Max. ratings: 7 mW

# 10 Troubleshooting



## Warning

- Risk of electric shock. Never remove the casing of the product.

To keep the warranty valid, never try to repair the product yourself.

If you have problems using this product, check the following points before you request service. If you still have a problem, register your product and get support at [www.philips.com/welcome](http://www.philips.com/welcome).

If you contact Philips, you will be asked for the model and serial number of your product. The model number and serial number are on the back or bottom of your product. Write the numbers here:

Model No. \_\_\_\_\_

Serial No. \_\_\_\_\_

---

## Main unit

**The buttons on this home theatre do not work.**

- Disconnect the home theatre from the socket for a few minutes, then reconnect.

---

## Picture

**No picture.**

- Ensure that the TV is switched to the correct source for this home theatre.

**No picture on HDMI connection.**

- If the connected device is not HDCP-compliant, you cannot transmit pictures through a HDMI connection. Use composite or component video connection.
- Check if the HDMI cable is faulty. Replace a new HDMI cable.
- If this happens when you change the HDMI video resolution, press **HDMI** repeatedly until the picture appears.

**No picture on the Component (Y Pb Pr) connection.**

- If the HDMI video connection is set to **[Auto]** or **[1080p/24Hz]**, there is no video output through the component connection. Change the HDMI video setting or remove the HDMI connection.

**No high-definition video signal on the TV.**

- Make sure that the disc contains high-definition video.
- Make sure that the TV supports high-definition video.

---

## Sound

**No sound.**

- Make sure that the audio cables are connected and select the correct input source (for example, **AUDIO SOURCE**, **USB**) for the device you want to play.



#### **No sound on HDMI connection.**

- If the connected device is not HDCP-compliant or is only DVI-compatible, you cannot transmit sound through an HDMI connection. Use an analogue or digital audio connection.
- Make sure that the **[HDMI Audio]** setting is turned on.

#### **No sound from TV programme.**

- Connect an audio cable from the audio input on this home theatre to the audio output on your TV. Then press **AUDIO SOURCE** repeatedly to select the correct audio source.

#### **No surround sound effect from the speakers.**

- Press **SURR. SOUND** to select a correct surround sound setting.
- Ensure that the source you play is recorded or broadcast in surround sound (Dolby Digital, etc). Sound cannot transmit through HDMI connection if the connected device is non-HDCP compliant or only DVI-compatible. Make an analogue or digital audio connection.

---

## **Play**

#### **Disc cannot be played.**

- Ensure that this product supports the disc. See 'Specifications'.
- Ensure that this product supports the region code of the DVD or BD.
- For DVD±RW or DVD±R, ensure that the disc is finalised.
- Clean the disc.

#### **Data files (JPEG, MP3, WMA) cannot be played or read.**

- Ensure that the data file was recorded in the UDF, ISO9660 or JOLIET format.
- Ensure that the JPEG file extension is .jpg, .JPG, .jpeg or .JPEG.
- Ensure that the MP3/WMA file extension is .mp3 or .MP3, and .wma or .WMA for windows Media™ Audio.

#### **DivX video files cannot be played.**

- Ensure that the DivX video file is complete.
- Ensure that the file name extension is correct.

#### **The contents of the USB flash drive cannot be read.**

- The USB flash drive format is not compatible with this product.
- Drive is formatted with a different file system which is not supported by this product (e.g. NTFS).

#### **'No entry' sign appears on the TV.**

- The operation is not possible.

#### **Unable to access BD-Live feature.**

- Check the network connection or ensure that the network has been set up.
- Clear local storage, internal memory (if any) or USB.
- Ensure that the BD disc supports the BD Live feature.

# 11 Glossary

---

## A

### AVCHD

AVCHD is a new format (standard) for high definition video cameras that can be used to record and play high-resolution HD images.

---

## B

### BD-J

Some BD-Video discs contain Java applications, and these applications are called BD-J. You can enjoy various interactive features in addition to playing normal video.

### Blu-ray Disc (BD)

A Blu-ray Disc is a next generation optical video disc capable of storing five times more data than a conventional DVD. The large capacity makes it possible to benefit from features such as high-definition videos, multichannel surround sound, interactive menus and so on.

### BONUSVIEW

This is a BD-Video (Final Standard Profile or Profile 1.1) that supports interactive content encoded on the disc, such as picture-in-picture. This means you can play the primary video and secondary video simultaneously.

## D

### DivX Video

DivX® is a digital video format created by DivX, Inc. This is an official DivX Certified device that plays DivX video. Visit [www.divx.com](http://www.divx.com) for more information and software tools to convert your files into DivX video.

### DivX Video-On-Demand

This DivX Certified ® device must be registered in order to play DivX Video-on-Demand (VOD) content. To generate the registration code, locate the DivX VOD section in your device setup menu. Go to [vod.divx.com](http://vod.divx.com) with this code to complete the registration process and learn more about DivX video.

### Dolby Digital

A surround sound system developed by Dolby Laboratories that contains up to six channels of digital audio (front left and right, surround left and right, centre and subwoofer.)

### Dolby Pro Logic IIx

An advanced, matrix decoding technology that expands any two channel or multi-channel 5.1 audio to 7.1 channel playback, resulting in a surround sound experience.

### Dolby TrueHD

Dolby TrueHD is a very high quality audio format that reproduces the studio master audio.

### DTS

Digital Theatre Systems. A surround sound system for providing 5.1 channels of discrete digital audio in consumer electronics products and software content. It is not developed by Dolby Digital.

### DTS-HD

DTS- HD is a high-quality, sophisticated audio format used in cinemas. Previous DTS Digital Surround-compatible equipment can play DTS-HD as DTS Digital Surround audio. BD-Video supports up to 7.1-channel output.

---

## H

### **HDCP**

High-bandwidth Digital Content Protection. This is a specification that provides a secure transmission of digital contents between different devices (to prevent unauthorised copyright.)

### **HDMI**

High-Definition Multimedia Interface (HDMI) is a high-speed digital interface that can transmit uncompressed high definition video and digital multichannel audio. It delivers high quality picture and sound quality, completely free from noise. HDMI is fully backward-compatible with DVI.

As required by the HDMI standard, connecting to HDMI or DVI products without HDCP (High-bandwidth Digital Content Protection) will result in no Video or Audio output.

---

## J

### **JPEG**

A very common digital still picture format. A still-picture data compression system proposed by the Joint Photographic Expert Group, which causes only a small decrease in image quality in spite of its high compression ratio. Files are recognised by their file extension '.jpg' or '.jpeg'.

---

## L

### **LAN (Local Area Network)**

A group of linked devices in a company, school or home. Indicates the boundaries of a particular network.

### **Local storage**

This storage area is used as destination for storing additional content from BD-Live enabled BD-Video.

---

## M

### **MP3**

A file format with a sound data compression system. MP3 is the abbreviation of Motion Picture Experts Group 1 (or MPEG-1) Audio Layer 3. With the MP3 format, one CD-R or CD-RW can contain about 10 times more data than a regular CD.

---

## P

### **PBC**

Playback Control. A system where you navigate through a Video CD/Super VCD with on-screen menus that are recorded onto the disc. You can enjoy interactive playback and search.

---

## W

### **WMA**

Windows Media™ Audio. Refers to an audio compression technology developed by Microsoft Corporation. WMA data can be encoded with Windows Media player version 9 or Windows Media player for Windows XP. Files are recognised by their file extension '.wma.'