



DIGITAL SURROUND RECEIVER SYSTEM



**PHILIPS**





### Important notes for users in the U.K.

#### Mains plug

This apparatus is fitted with an approved 13 Amp plug. To change a fuse in this type of plug proceed as follows:

- 1 Remove fuse cover and fuse.
- 2 Fix new fuse which should be a BS1362 5 Amp, A.S.T.A. or BSI approved type.
- 3 Refit the fuse cover:

If the fitted plug is not suitable for your socket outlets, it should be cut off and an appropriate plug fitted in its place.

If the mains plug contains a fuse, this should have a value of 5 Amp. If a plug without a fuse is used, the fuse at the distribution board should not be greater than 5 Amp.

*Note: The severed plug must be disposed of to avoid a possible shock hazard should it be inserted into a 13 Amp socket elsewhere.*

#### How to connect a plug

The wires in the mains lead are coloured with the following code: blue = neutral (N), brown = live (L).

- As these colours may not correspond with the colour markings identifying the terminals in your plug, proceed as follows:
  - Connect the blue wire to the terminal marked N or coloured black.
  - Connect the brown wire to the terminal marked L or coloured red.
  - Do not connect either wire to the earth terminal in the plug, marked E (or  $\frac{1}{2}$ ) or coloured green (or green and yellow).

Before replacing the plug cover, make certain that the cord grip is clamped over the sheath of the lead - not simply over the two wires.

#### Copyright in the U.K.

Recording and playback of material may require consent. See Copyright Act 1956 and The Performer's Protection Acts 1958 to 1972.

### Italia

#### DICHIARAZIONE DI CONFORMITA'

Si dichiara che l'apparecchio LX710 PHILIPS risponde alle prescrizioni dell'art. 2 comma 1 del D.M. 28 Agosto 1995 n. 548.

Fatto a Eindhoven

Philips Consumer Electronics  
Philips, Glaslaan 2  
5616 JB Eindhoven, The Netherlands

### Norge

Typeskilt finnes på apparatens underside.

**Observer: Nettbryteren er sekundert innkoplet. Den innebygde nettdelen er derfor ikke frakoplet nettet så lenge apparatet er tilsluttet nettkontakten.**

For å redusere faren for brann eller elektrisk støt, skal apparatet ikke utsettes for regn eller fuktighet.

### CAUTION

**Use of controls or adjustments or performance of procedures other than herein may result in hazardous radiation exposure or other unsafe operation.**

### VAROITUS

**Muiden kuin tässä esitettyjen toimintojen säädön tai asetusten muutto saattaa altistaa vaaralliselle säteilylle tai muille vaarallisille toiminnoille.**



**This AV Receiver is in conformity with the EMC directive and low-voltage directive.**



# Index

English ..... 4

Français ..... 46

Español ..... 86

Deutsch ..... 126

Nederlands ..... 166

Italiano ..... 206

English

Français

Español

Deutsch

Nederlands

Italiano

*This product complies with the radio interference requirements of the European Community.*

**Manufactured under license from Dolby Laboratories. “Dolby”, “Pro Logic” and the double-D symbol are trademarks of Dolby Laboratories.**

**Manufactured under license from Digital Theater Systems, Inc. U.S. Pat. Nois. 5,451,942; 5,956,674; 5,974,380; 5,978,762; 6,226,616; 6,487,535 and other U.S. and world-wide patents issued and pending. “DTS” and “DTS Digital Surround” are registered trademarks of Digital Theater Systems, Inc. All Rights Reserved.**



English

# Contents

## General Information

Supplied accessories .....	5
Care and safety information .....	5

## Connections

Step 1: Set up the speakers .....	6
Step 2: Placing the speakers and subwoofer ..	6
Step 3: Connecting speakers and subwoofer .	7
Step 4: Connecting FM/MW antennas .....	8
Step 5: Connecting the power cord .....	8

## Optional Connections - Playback

Connecting to TV/VCR/other audio devices .....	9
Connecting to a DVD/SACD player .....	10
Option 1: Using 7 Channel In jacks .....	10
Option 2: Using Coaxial In jack .....	10
Option 3: Using Optical In jack .....	10

## Optional Connections - Recording

Connecting to a recording device .....	11
--	----

## Functional Overview

Main unit and remote control .....	12
Control buttons available on the remote only .....	13

## Getting Started

Step 1: Inserting batteries into the remote control .....	14
Using the remote control to operate the system .....	14
Step 2: Switching On/Off .....	14
Switching to an active mode .....	14
Switching to standby mode .....	14
Step 3: Setting the speakers .....	14–15
Adjusting the speaker output levels .....	15

## Sound Controls

Selecting surround sound .....	16
Selecting digital sound effects .....	16
Adjusting the Bass/Treble level .....	16

## Volume Controls and Other Features

Volume Control .....	17
Night Mode - turning on/off .....	17
Dimming system's display screen .....	17
Setting the Sleep Timer .....	17

## Tuner Operations

Tuning to radio stations .....	18
Presetting radio stations .....	18
Automatic presetting .....	18
Manual presetting .....	18
Selecting a preset radio station .....	18

## Troubleshooting

.....	19
-------	----

## Specifications

.....	20
-------	----









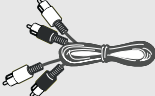

## Glossary

.....	21
-------	----

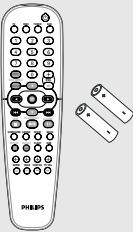

## General Information

### Supplied accessories

Speaker cables	 (6x)
Subwoofer cable	
Audio cables (red, white)	
Coaxial cable	
FM wire antenna	
MW loop antenna	
Remote control and two batteries (12nc: 3139 238 04881)	
Power cable	
Speaker brackets and screws	 (5x)
Speaker bases	 (5x)

### Care and safety information

#### Avoid high temperatures, moisture, water and dust

- Apparatus shall not be exposed to dripping or splashing.
- Do not place any sources of danger on the apparatus (e.g. liquid filled objects, lighted candles).

#### Do not block any ventilation openings

- Place the apparatus in a location with adequate ventilation to prevent internal heat build up. Allow at least 10cm (4 inches) of free space all around the apparatus for adequate ventilation.

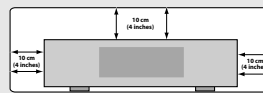

#### Finding a suitable location

- Place the player on a flat, hard, stable surface.
- Do not position the set on top of other equipment that might heat it up (e.g. DVD player or amplifier).

#### Care of the cabinet

- Use a soft cloth slightly moistened with a mild detergent solution. Do not use a solution containing alcohol, spirits, ammonia or abrasives.

English



## Connections

English

### Step 1: Set up the speakers

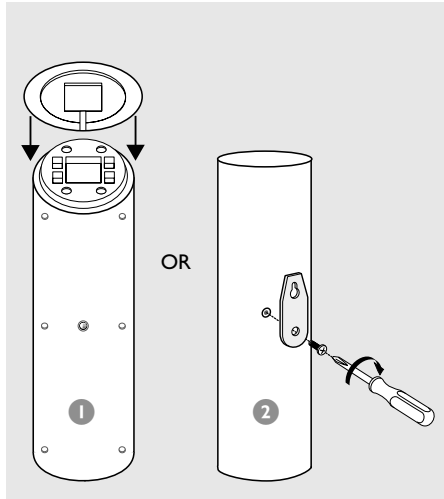

- 1 You can attach the speakers directly to their bases if you want to place them on a flat surface.
- OR
- 2 You can choose to hang the speakers on the wall. Attach the supplied bracket firmly to the rear of speakers using the supplied screws. Then mount a screw (not supplied) on the wall where the speaker is to be hung and hook the speaker securely onto the mounted screw.

#### CAUTION!

**You should get a qualified person to attach the brackets to the wall. DO NOT do it by yourself to avoid unexpected damage to the equipment or injury to personnel.**

#### Helpful Hints:

- The rear speakers are labelled as REAR C (centre), REAR L (left) or REAR R (right).
- The front speakers are labelled as FRONT L (left) or FRONT R (right).

### Step 2: Placing the speakers and subwoofer

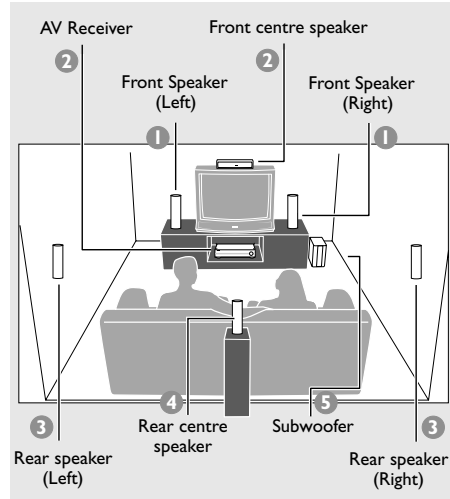

For best possible surround sound, all the speakers (except subwoofer) should be placed at the same distance from the listening position.

- 1 Place the front left and right speakers at equal distances from the TV and at an angle of approximately 45 degrees from the listening position.
- 2 Place the centre speaker above the TV or the AV receiver so that the centre channel's sound is localised.
- 3 Place the rear speakers at normal listening ear level facing each other or mounted on the wall.
- 4 Place the rear centre speaker behind the listening position or mounted on the wall.
- 5 Place the subwoofer on the floor near the TV.

#### Helpful Hints:

- To avoid magnetic interference, do not position the front speakers too close to your TV.
- Allow adequate ventilation around the AV receiver.



## Connections

### Step 3: Connecting speakers and subwoofer

English

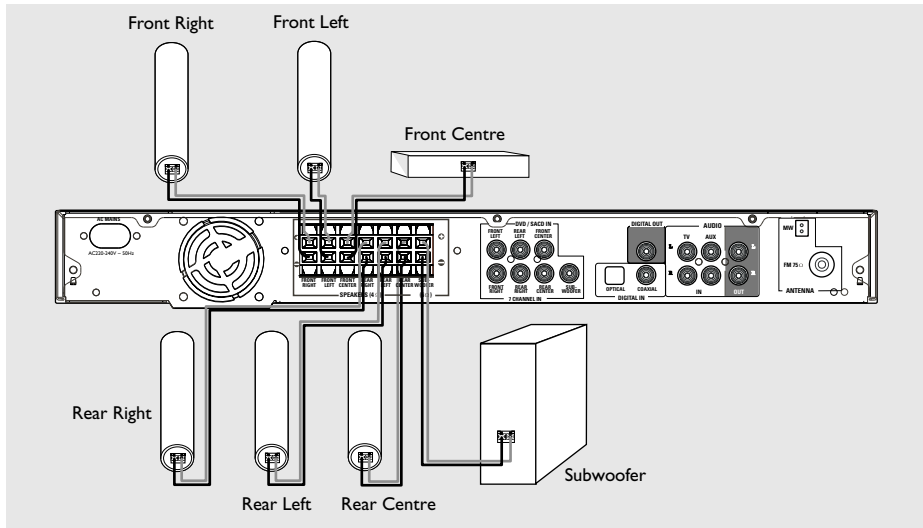

- Connect the supplied speaker systems by matching the colours of the jacks and speaker cables. Fully insert the stripped portion of the speaker wire into the jacks.

Speakers	⊖	⊕
FRONT LEFT (FL)	black	white
FRONT RIGHT (FR)	black	red
FRONT CENTRE (FC)	black	green
REAR LEFT (RL)	black	blue
REAR RIGHT (RR)	black	gray
REAR CENTRE (RC)	black	brown
SUBWOOFER (SUBW)	black	purple

#### Helpful Hints:

- Ensure that the speaker cables are correctly connected. Improper connections may damage the system due to short-circuit.
- Do not connect more than one speaker to any one pair of +/- speaker jacks.
- Do not connect speakers with impedance lower than the speakers supplied. Please refer to the SPECIFICATIONS section of this manual.





## Connections

English

### Step 4: Connecting FM/MW antennas

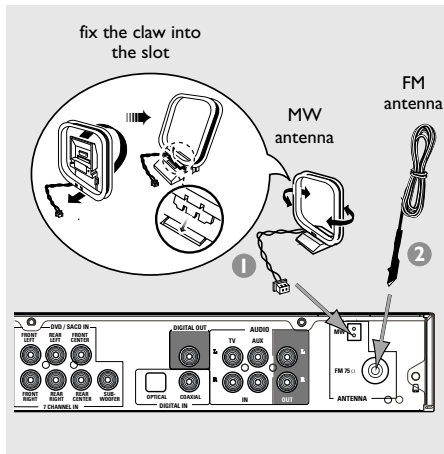

- 1 Connect the supplied MW loop antenna to the **MW** jack. Place the MW loop antenna on a shelf or attach it to a stand or wall.
- 2 Connect the supplied FM antenna to the **FM** jack. Extend the FM antenna and fix its ends to the wall.

For better FM stereo reception, connect an external FM antenna (not supplied).

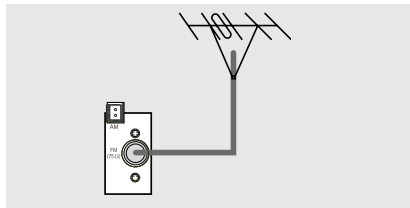

#### Helpful Hints:

- Adjust the position of the antennas for optimal reception.
- Position the antennas as far as possible from your TV, VCR or other radiation source to prevent unwanted interference.

### Step 5: Connecting the power cord

**After everything is connected properly, plug in the AC power cord to the power outlet.**

Never make or change any connections with the power switched on.

#### Helpful Hint:

- Refer to the type plate on the rear or bottom of the system for identification and supply ratings.





## Optional Connections - Playback

### IMPORTANT!

- You can connect other audio and audio/visual equipment to this AV receiver in order to use the Home Cinema Audio System's surround sound capabilities.
- For connection to additional components, the audio/video cables are not supplied.
- When making connections, make sure the colour of cables matches the colour of jacks.
- Always refer to the instruction manual of the connected equipment to make an optimal connection.

English

### Connecting to TV/VCR/other audio devices

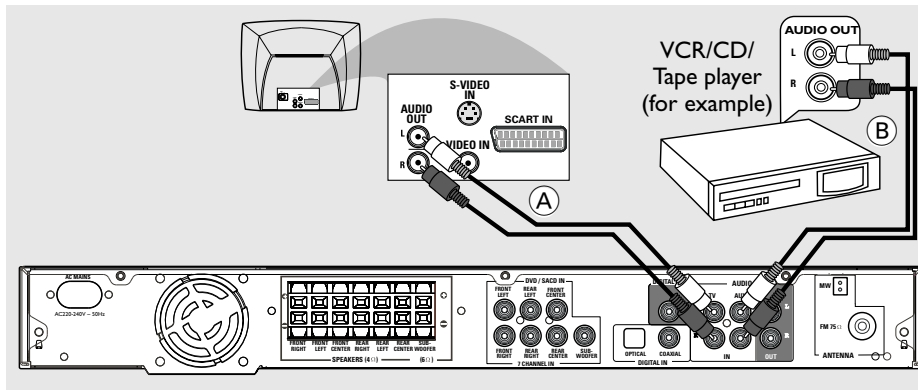

- To hear the TV channels through this AV receiver, use the audio cables (white/red) to connect AUDIO IN-TV jacks to the corresponding AUDIO OUT jacks on the TV (see fig A).
- To hear the playback of other audio/visual devices (such as VCR, MP3 player, cassette player), use the audio cables (white/red) to connect AUDIO IN-AUX jacks to the corresponding AUDIO OUT jacks on the connected audio device (see fig B).

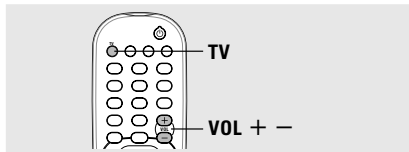

Before starting operation,

- 1 Start playback the connected source as usual.
- 2 Press **TV** on the remote to activate the input source, then press **VOL + -** to adjust the volume level.

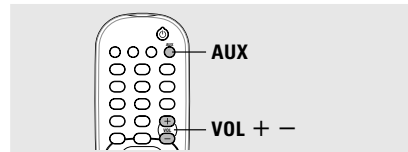

Before starting operation,

- 1 Start playback the connected source as usual.
- 2 Press **AUX** on the remote to activate the input source, then press **VOL + -** to adjust the volume level.





## Optional Connections - Playback

### Connecting to a DVD/SACD player

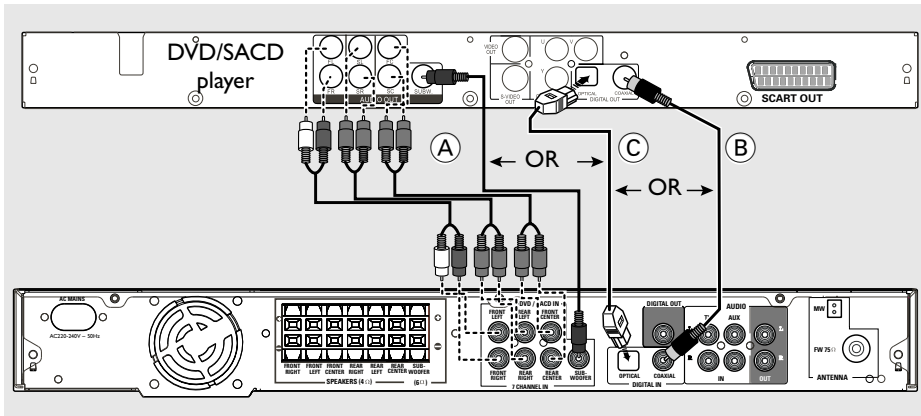

You only need to make one connection to your DVD/SACD player from the following options, depending on the capabilities of your DVD/SACD player.

#### Option 1: Using 7 Channel In jacks

- If your DVD/SACD player has a built-in multichannel decoder (e.g. Dolby Digital, DTS) and has 7-channel (multichannel) output jacks, you may use the audio cables (not supplied) to connect the AV receiver's **7 CHANNEL IN** jacks to the corresponding output jacks on the DVD/SACD player (see fig (A)).

Before starting operation,

- 1 Start playback the connected source as usual.
- 2 Press **DISC** on the remote to select "**DISC 7CH**" in order to activate the input source, then press **VOL + -** to adjust the volume level.

*Helpful Hints:*

- The audio signals produced by 7-channel is multichannel surround. Therefore, switching to Stereo or VSS mode has no effect.
- Making recording from this input is not possible.

#### Option 2: Using Coaxial In jack

- Or, use an coaxial cable to connect the AV receiver's **COAXIAL IN** jack to the **COAXIAL** output jack on the DVD/SACD player (see fig (B)).

Before starting operation,

- 1 Start playback the connected source as usual.
- 2 Press **DISC** on the remote to select "**DISC COAX**" in order to activate the input source, then press **VOL + -** to adjust the volume level.

#### Option 3: Using Optical In jack

- Or, use an optical fiber-optic cable (not supplied) to connect the AV receiver's **OPTICAL IN** jack to the **OPTICAL** output jack on the DVD/SACD player (see fig (C)).

Before starting operation,

- 1 Start playback the connected source as usual.
- 2 Press **DISC** on the remote to select "**DISC OPTI**" in order to activate the input source, then press **VOL + -** to adjust the volume level.



## Optional Connections - Recording

### Connecting to a recording device

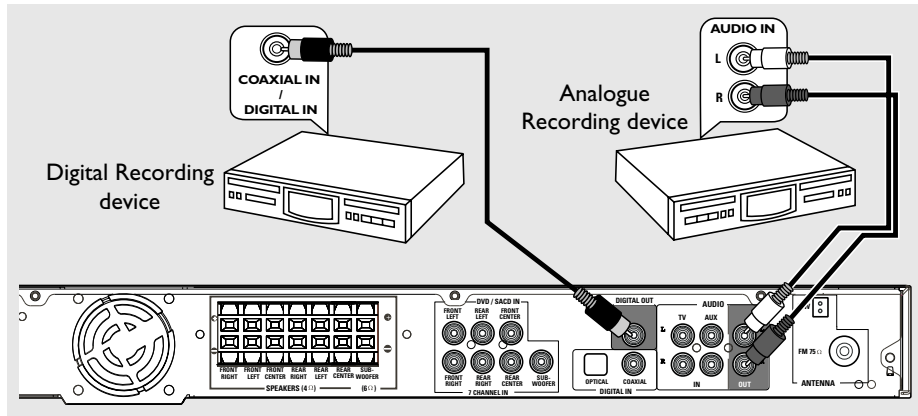

English

- Connect the AV receiver's **COAXIAL OUT** jack to the **DIGITAL (COAXIAL) IN** jack on a digital recording device (DTS-Digital Theatre System compatible, with a Dolby Digital decoder, for example).  
→ This will allow you to make digital or analogue recordings from the signals received from this AV receiver.

AND/OR

- Connect the AV receiver's **AUDIO OUT** jacks to the **AUDIO IN** jacks on an analogue recording device.  
→ This will allow you to make analogue stereo (two-channel, left and right) recordings.

*Helpful Hints:*

- Dolby Digital, DTS or MPEG signal are not possible to record from this AV receiver.
- Digital recording is not possible when the digital source material is copy-protected.

Before starting recording,

- 1 Press **DISC**, **TUNER**, **TV** or **AUX** to select the source you want to record from.  
→ The name of the source appears on the display panel.
- 2 Start recording on the external recording device.
- 3 Start playback the connected source as usual.

*Helpful Hints:*

- Recording from 7-Channel input source is not possible.
- The sound settings will not affect the recording.



## Functional Overview

English

### Main unit and remote control

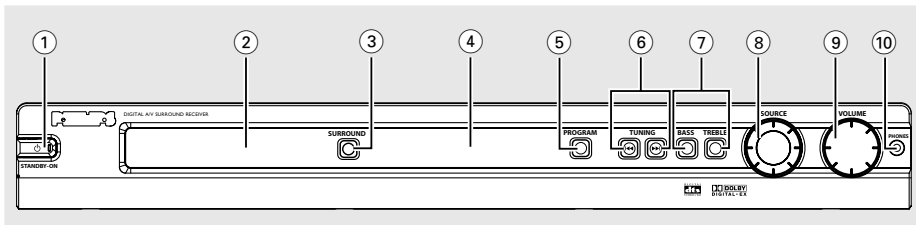

#### ① STANDBY ON (⏻)

- Switches to standby mode or turns on the system.

#### ② Speaker display panel

#### ③ SURROUND

- Selects multichannel surround or stereo mode.

#### ④ System display panel

#### ⑤ PROGRAM

- \*Enters receiver setup menu.
- TUNER: starts automatic/manual preset programming.

#### ⑥ ◀◀ TUNING ▶▶

- Tunes the radio frequency up/down.

#### ⑦ BASS/TREBLE

- Selects BASS (low tone) or TREBLE (high tone) sound mode and use the VOLUME control to change the tone level.

#### ⑧ SOURCE

- Selects the relevant active source mode: DISC (7CH/COAX/OPTI), TUNER (FM/MW), AUX or TV.

*(on the remote only)*

- TV: switches to TV source mode.
- DISC: toggles between DISC 7CH, DISC COAX and DISC OPTI source mode.
- TUNER: toggles between FM and MW band.
- AUX: selects AUX mode.

#### ⑨ VOLUME (VOL + -)

- Adjusts the volume level.
- Selects a setting in receiver setup menu.

#### ⑩ PHONES

- Plug in the headphones jack. The speakers output will be cancelled.

\* = Press and hold the button for more than five seconds.



## Functional Overview

### Control buttons available on the remote only

- ⑪ ◀ ▶  
– Use ▶▶ to select a preset radio station.
- ⑫ **SOUND**  
– Selects a sound effect.
- ⑬ **SUBW** + –  
– Adjusts subwoofer's sound level.  
**REAR** + –  
– Adjusts rear speakers' sound level.  
**CENTER** + –  
– Adjusts centre speaker's sound level.  
**TVVOL** + –  
– Adjusts TV volume (Philips TV only).
- ⑭ **SLEEP**  
– Sets the sleep timer function.
- ⑮ **DIM**  
– Selects different levels of brightness for display panel.
- ⑯ **MUTE**  
– Mutes or restores the volume.
- ⑰ **NIGHT** (in Dolby Digital EX or Dolby Digital mode only)  
– Optimises the dynamic of the sound output
- ⑱ **Numeric Keypad (0-9)**  
– Enters a number of a preset radio station.
- ⑲ ⏻  
– Switches to standby mode.

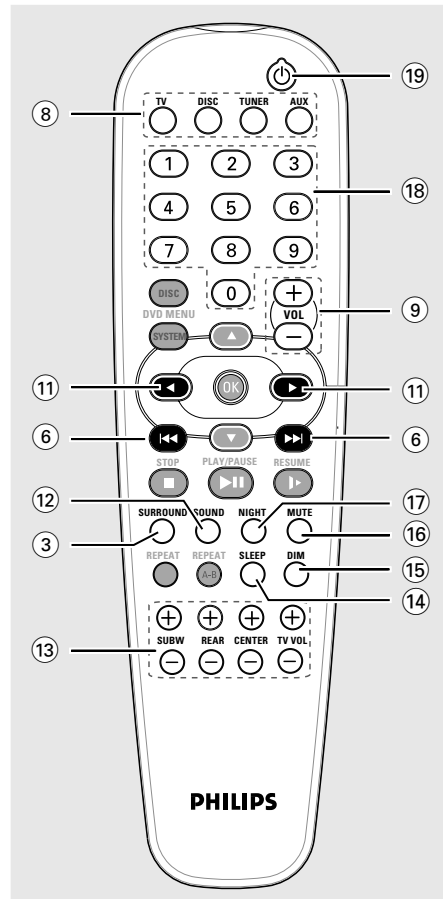

English

The following keys only operate on a Philips DVD player. For details, please refer to a Philips DVD player owner's manual

- **DVD MENU - DISC**
- **DVD MENU - SYSTEM**
- ▲▼
- **OK**
- **STOP**
- **PLAY/PAUSE**
- **RESUME**
- **REPEAT**
- **REPEAT A-B**

\* = Press and hold the button for more than five seconds.



## Getting Started

### Step 1: Inserting batteries into the remote control

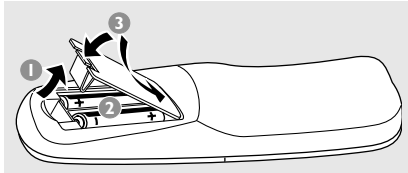

- 1 Open the battery compartment.
- 2 Insert two batteries type R06 or AA, following the indications (+ -) inside the compartment.
- 3 Close the cover.

### Using the remote control to operate the system

- 1 Aim the remote control directly at the remote sensor (iR) on the front panel.
- 2 Select the source you wish to control by pressing one of the source select buttons on the remote control (for example TV, TUNER).
- 3 Then select the desired function (for example ◀◀ ▶▶).

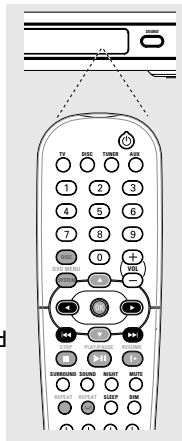

### CAUTION!

- Remove batteries if they are exhausted or if the remote is not to be used for a long time.
- Do not use old and new or different types of batteries in combination.
- Batteries contain chemical substances, so they should be disposed of properly.

### Step 2: Switching on/off

After completing all the connections, connect the AC power cord of the AV receiver to the wall outlet.

#### Switching to an active mode

- Press the **SOURCE** control to select :  
DISC 7CH → DISC COAX →  
DISC OPTI → FM/MW → AUX →  
TV → DISC 7CH ....

OR

Press **TV, DISC, TUNER** or **AUX** on the remote.

#### Switching to standby mode

- Press **STANDBY ON** (⏻).  
→ The display screen will go blank.

### Step 3: Setting the speakers

You can adjust the delay times (centre and rear only) and volume level for individual speakers. These adjustments let you optimise the sound according to your surroundings and setup.

#### IMPORTANT!

- Press **SURROUND** button to select **Multi-channel surround mode** before adjusting the speaker settings.
- Set the 'Test Tone' to 'On' for easy adjustment.

- 1 In active mode, press and hold **PROGRAM** for five seconds to enter system setup.
- 2 Press ◀◀ / ▶▶ to select one of the following options : *CENTER DELAY*, *REAR DELAY*, *TEST TONE* or *MENU OFF*.
- 3 Press **PROGRAM** to confirm.



## Getting Started

**CENTER DELAY** – Select this to set the delay time in relation to the listening position/distance for the centre speaker : 5ms, 3ms, 2ms, 1ms or OFF (default setting).

**REAR DELAY** – Select this to set the delay time in relation to the listening position/distance for rear speakers : 15ms, 12ms, 9ms, 6ms, 3ms or OFF (default setting).

**TEST TONE** – Select this to turn 'ON' or 'OFF' (default setting) the test tone. If you have turned on the test tone, the test signal will be automatically generated to help you judge the sound level of each speaker and subwoofer.

**MENU OFF** – Select this to exit from the system setup.

- 4 Use the **VOLUME** control to adjust the settings that best suit your surround sound needs.
  - If the volume control is not used within 5 seconds, it will become normal volume control function.
- 5 Press **PROGRAM** to confirm your selection.

### Helpful Hints:

- Use the longer delay time settings when the rear speakers are closer to the listener than the front speakers.
- If "CHECK SURROUND SETTINGS" appears on the display, press **SURROUND** button to select surround mode.
- "AUTO PROG" only available for selection in tuner mode only.

### Adjusting the speaker output levels

You can adjust the rear speakers, centre speaker and subwoofer output levels by comparing the sound from the front speakers.

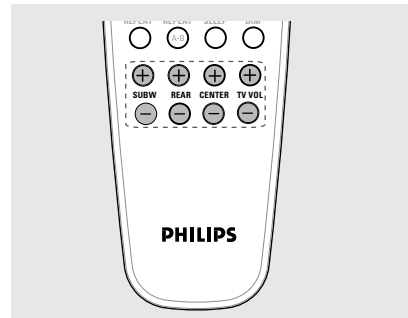

- Press the respective buttons on the remote (**REAR + -**, **CENTER + -** and **SUBW + -**) to adjust the output level between -15dB ~ 10dB.

### Helpful Hint:

- If you have selected Stereo or VSS mode, adjusting the centre and rear speakers' volume level will have no effect.





## Sound Controls

### IMPORTANT!

**For proper surround sound, make sure the speakers and subwoofer are connected (see page 7).**

– The availability of the various surround sound modes depends on the number of speakers used and the sound available on the disc.

### Selecting surround sound

#### In DISC COAX or DISC OPTI mode

- If receiving Dolby Digital EX and Dolby Digital 5.1 audio signal, press **SURROUND** button will cyclic through:  
DOLBY EX → DOLBY D (Digital) → STEREO → VSS (Virtual Surround Sound)
- If receiving Dolby Digital 2.0 and PCM audio signal, press **SURROUND** button will cyclic through:  
DOLBY PLII MOVIE → DOLBY PLII MUSIC → DOLBY PL (ProLogic) → STEREO → VSS (Virtual Surround Sound)
- If receiving DTS audio signal, press **SURROUND** button will cyclic through:  
DTS (Digital Theatre Systems) → STEREO → VSS (Virtual Surround Sound)

#### In TV, Tuner or AUX mode;

- Press **SURROUND** button will cyclic through:  
DOLBY PLII MOVIE → DOLBY PLII MUSIC → DOLBY PL (ProLogic) → STEREO → VSS (Virtual Surround Sound)

#### Helpful Hints:

- The available Surround outputs include: Dolby Digital EX, Dolby Digital, DTS (Digital Theatre Systems) Surround, Dolby Pro Logic II and Dolby Pro Logic.
- In VSS (Virtual Surround Sound) mode, the surround channel is reproduced through two front speakers.
- MOVIE and MUSIC are Dolby Pro Logic II surround sound.
- The surround feature is not available in DISC 7CH mode.
- The centre and rear speakers operate only in multichannel surround mode.

### Selecting digital sound effects

Select a preset digital sound effects that matches your disc's content or that optimises the sound of the musical style you are playing.

- Press **SOUND** on the remote to select the available sound effect.

In Dolby Digital EX, Dolby Digital, DTS, PRO LOGIC or PRO LOGIC II (MOVIE) surround mode, you can select :  
CONCERT, DRAMA, ACTION or SCI-FI.

In VSS, PRO LOGIC II (MUSIC) surround mode or in Tuner mode, you can select :  
JAZZ, ROCK, DIGITAL or CLASSIC.

#### Helpful Hint:

- For flat sound output, select CONCERT or CLASSIC.

### Adjusting the Bass/Treble level

The BASS (low tone) and TREBLE (high tone) features enable you to define the sound-processor settings.

- 1 Press **BASS** or **TREBLE**.
- 2 Within two seconds, use the **VOLUME** control to adjust the Bass or Treble level (-10dB ~ 10dB, default setting - 0dB).  
→ If the volume control is not used within two seconds, it will resume its normal volume control function.  
→ If headphone is connected, it will disable the bass/treble controls.





## Volume Controls and Other Features

### Volume control

- Adjust **VOLUME** control (or press **VOL +/–** on the remote) to increase or decrease the volume level.  
→ "**VOL MIN**" is the minimum volume level and "**VOL MAX**" is the maximum volume level.

#### For Philips TVs only

- Press **TVVOL +/–** on the remote control to adjust the TV's volume level.

#### To listen through the headphones

- Connect the headphones plug to the **PHONE** socket at the front of the AV receiver.  
→ The speakers will be mute.  
→ The current surround sound will change to stereo sound.

#### To turn off the volume temporarily

- Press **MUTE** on the remote.  
→ Playback will continue without sound and "**MUTE**" icon appears.  
→ To restore the volume, press **MUTE** again or increase the volume level.

### Night Mode - turning on/off

When activated the night mode, the high volume outputs will be softened and low volume outputs will be brought upward to an audible level. It is useful for watching your favourite action movie without disturbing others at night.

#### IMPORTANT!

**This feature is only available for the source that has recorded in Dolby Digital EX or Dolby Digital format.**

- Press **NIGHT** on the remote repeatedly to switch the Night mode on or off (default setting - OFF).

#### Helpful Hint:

- The night mode option is not available in **DISC 7CH** mode.

### Dimming system's display screen

- In any active mode, press **DIM** on the remote to select desired brightness : **HIGH** (default setting), **MID** or **LOW**.

### Setting the Sleep Timer

The sleep timer enables the system to switch to standby mode automatically at a preset time.

- Press **SLEEP** on the remote repeatedly until it reaches the desired preset turn-off time.  
→ The selections are as follows (time in minutes):  
15 → 30 → 45 → 60 → 90 → 120  
→ OFF → 15 ...  
→ "**SLEEP**" icon will show on the display, except if "OFF" is selected.

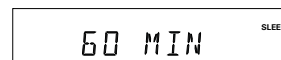

#### To check or change the setting

- Press **SLEEP** once to show the remaining time before switching off. If you continue pressing the **SLEEP** button, the next Sleep Timer option will appear.

#### To cancel the sleep timer

- Press **SLEEP** repeatedly until "OFF" appears or press the **STANDBY ON** button.





## Tuner Operations

**IMPORTANT!**  
Make sure the FM and MW antennas are connected.

### Tuning to radio stations

- 1 Press **TUNER** on the remote to select "FM" or "MW".
- 2 Press and hold **◀◀ / ▶▶** on the remote until the frequency indication starts to change, then release.  
→ "FM SEARCH" appears.  
→ The next radio station will tune automatically.  
→ ∞ lights up for FM stereo reception.
- 3 To tune a weak station, press **◀◀ / ▶▶** briefly and repeatedly until an optimal reception is found.

#### Helpful Hint:

– If the FM radio station is transmitting RDS (Radio Data System) signal, the RDS name will be displayed and stored.

### Presetting radio stations

You can store up to 40 preset radio stations in the memory.

#### Automatic presetting

You can store all available radio stations automatically.

- 1 In tuner mode, press and hold **PROGRAM** for five seconds to enter system setup.
- 2 Press **◀◀ / ▶▶** to select "AUTO PROG".

- 3 Press **PROGRAM** to confirm.  
→ "CONFIRM" appears.

- 4 Press **PROGRAM** to start automatic presetting.  
→ "SEARCH" appears.  
→ All the available radio stations with strong transmission signal will be stored.  
→ Automatic preset will begin from preset (1) and all your former presets will be overridden.

#### Manual presetting

You can choose to store only your favourite radio stations.

- 1 Tune to your desired radio station (see "Tuning to radio stations").
- 2 Press **PROGRAM**.  
→ "PROGRAM" and "PRESET" icons appear.

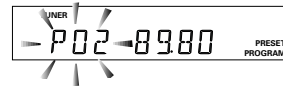

- 3 Use the **numeric keypad (0-9)** to select a desired preset number.  
→ If "PROGRAM" icon goes off before you select the desired preset number, press PROGRAM button again.
- 4 Press **PROGRAM** again to store.
- 5 Repeat steps 1~4 to store other radio stations.

#### Helpful Hints:

– If you attempt to program more than 40 preset radio stations, "PROG FULL" appears.  
– The system will exit presetting mode if no button is pressed within two seconds.

### Selecting a preset radio station

- Press **◀ ▶** or use the **numeric keypad (0-9)** to select a preset number.  
→ The preset number follow by radio frequency will appear.



## Troubleshooting

### WARNING

Under no circumstances should you try to repair the system yourself, as this will invalidate the warranty. Do not open the system as there is a risk of electric shock.

If a fault occurs, first check the points listed below before taking the system for repair. If you are unable to remedy a problem by following these hints, consult your dealer or Philips for help.

Problem	Solution
<b>No power.</b>	<ul style="list-style-type: none"> <li>– Check if the AC power cord is properly connected.</li> </ul>
<b>No sound or distorted sound.</b>	<ul style="list-style-type: none"> <li>– Adjust the volume.</li> <li>– Check the speaker connections and settings.</li> <li>– Disconnect the headphones.</li> <li>– Press the correct source button on the remote (TV or AUX, for example) to choose the equipment that you want to hear through the AV receiver.</li> </ul>
<b>There is no sound from the centre and rear speakers.</b>	<ul style="list-style-type: none"> <li>– Press CENTER + – or REAR + – to adjust the volume level.</li> <li>– Make sure the centre and rear speakers are connected correctly.</li> <li>– Press SURROUND button to select a correct surround sound setting.</li> <li>– Make sure the source you are playing is recorded or broadcast in surround sound (DTS, Dolby Digital, etc.).</li> </ul>
<b>Radio reception is poor.</b>	<ul style="list-style-type: none"> <li>– If the signal is too weak, adjust the antenna or connect an external antenna for better reception.</li> <li>– Increase the distance between the system and your TV or VCR.</li> <li>– Tune in to the correct frequency.</li> <li>– Place the antenna farther away from any equipment that may be causing the noise.</li> </ul>
<b>The remote control does not function properly.</b>	<ul style="list-style-type: none"> <li>– Select the source (DISC or TUNER, for example) before pressing the function button (◀◀ ▶▶).</li> <li>– Reduce the distance between the remote control and the system.</li> <li>– Replace the batteries with new ones.</li> <li>– Point the remote control directly toward the IR sensor.</li> <li>– Check that the batteries are loaded correctly.</li> </ul>
<b>Low hum or buzz sound.</b>	<ul style="list-style-type: none"> <li>– Place the AV Receiver as far away as possible from electrical devices that may be causing interference.</li> </ul>



English

## Specifications

### AMPLIFIER SECTION

Output power	
- Front	75 W RMS <sup>①</sup> / channel
- Rear	75 W RMS <sup>①</sup> / channel
- Centre	75 W RMS <sup>①</sup> / channel
Frequency Response	200 Hz – 20 kHz
- Subwoofer	150 W RMS
Frequency Response	40 Hz – 200 Hz
Signal-to-Noise Ratio	> 60 dB
Input Sensitivity	
- TV In	400 mV
- AUX In	400 mV
- 7 Channel In	800 mV
<sup>①</sup> 4ohm, 1 kHz, 10% THD	

### TUNER SECTION

Tuning Range	FM 87.5 – 108 MHz (50 kHz) MW 531 – 1602 kHz (9 kHz)
26 dB Quieting Sensitivity	FM 22 dBf MW 4 µV/m
IF Rejection Ratio	FM 60 dB MW 24 dB
Signal-to-Noise Ratio	FM 60 dB MW 40 dB
Harmonic Distortion	FM Mono 3% FM Stereo 3% MW 5%
Frequency Response	FM 180 Hz – 10 kHz / ±6 dB
Stereo Separation	FM 26 dB (1 kHz)
Stereo Threshold	FM 23.5 dB

### MAIN UNIT

Power Supply Rating	220 – 240 V; 50 Hz
Power Consumption	180 W
Dimensions (w x h x d)	435 mm x 60 mm x 365 mm
Weight	4.96 kg

### SPEAKERS

Front / Rear/ Rear Centre speakers	
System	2-way, closed box system
Impedance	4 Ω
Speaker drivers	44mm tweeter + 51mm woofer
Frequency response	200 Hz – 20 kHz
Dimensions (w x h)	73 mm x 288 mm
Weight	approx. 0.80 kg/each

### CENTRE SPEAKER

System	5 multi directional driver
Impedance	4 Ω
Speaker drivers	44mm tweeter + 51mm woofer
Frequency response	200 Hz – 20 kHz
Dimensions (w x h x d)	435 mm x 73 mm x 65 mm
Weight	1.21 kg

### SUBWOOFER

Frequency response	40 Hz – 200 Hz
Impedance	6 Ω
Dimensions (w x h x d)	186 mm x 360 mm x 350 mm
Weight	4.93 kg

Specifications subject to change without prior notice



## Glossary

**Analogue:** Sound that has not been turned into numbers. Analogue sound varies, while digital sound has specific numerical values. These jacks send audio through two channels, the left and right.

**AUDIO OUT Jacks:** Jacks on the back of the DVD System that send audio to another system (TV, Stereo, etc.).

**Digital:** Sound that has been converted into numerical values. Digital sound is available when you use the DIGITAL AUDIO OUT COAXIAL or OPTICAL jacks. These jacks send audio through multiple channels, instead of just two channels as analog does.

**Dolby Digital:** A surround sound system developed by Dolby Laboratories capable of delivering up to 5.1 discrete channels of audio (front left and right, rear left and right, centre, and LFE).

**Dolby Digital EX:** It is the technology employs highly advanced Dolby matrix decoding to add a third surround channel to Dolby Digital 5.1-channel soundtracks. Located at the centre back position, this additional rear surround channel complements the left and right surround channels of Dolby Digital 5.1-channel audio to product an intensified degree of realism, further immersing movie viewers in the on-screen action.

**Dolby Surround Pro Logic:** It is the technology that decodes programme material encoded in Dolby Surround; it is built into virtually every home theater audio system. Like the professional decoder units used in cinemas, Dolby Surround Pro Logic reconstructs the original four channels-left, center, right and surround that were encoded onto the programme material's stereo soundtracks.

**Dolby Surround Pro Logic II:** It is an improved matrix decoding technology that provides better spatiality and directionality on Dolby Surround programme material; provides a convincing three-dimensional soundfield on conventional stereo music recordings; and is ideally suited to bring the surround experience to automotive sound. While conventional surround programming is fully compatible with Dolby Surround Pro Logic II decoders, soundtracks will be able to be encoded specifically to take full advantage of Pro Logic II playback, including separate left and right surround channels. (Such material also compatible with conventional Pro Logic decoders).

**DTS:** Digital Theatre Systems. This is a surround sound system, but it is different from Dolby Digital. The formats were developed by different companies.

**Multichannel:** DVD is specified to have each sound track constitute one sound field. Multichannel refers to a structure of sound tracks having three or more channels.

**Super Audio CD (SACD):** This audio format is based upon the current CD standards but includes a greater amount of information that provides higher quality sound. There are three types of discs: single layer, double layer and hybrid discs. The hybrid disc contains both standard audio CD and Super Audio CD information.

**Surround:** A system for creating realistic three-dimensional sound fields full of realism by arranging multiple speakers around the listener.

**VSS:** Virtual Surround Sound - the ProLogic MPEG or Dolby Digital surround channel is processed by a 'virtualiser' DSP to add surround effect from just the two front speakers.

# Quick Use Guide

LX710

# PHILIPS

12nc: 8239 300 30621

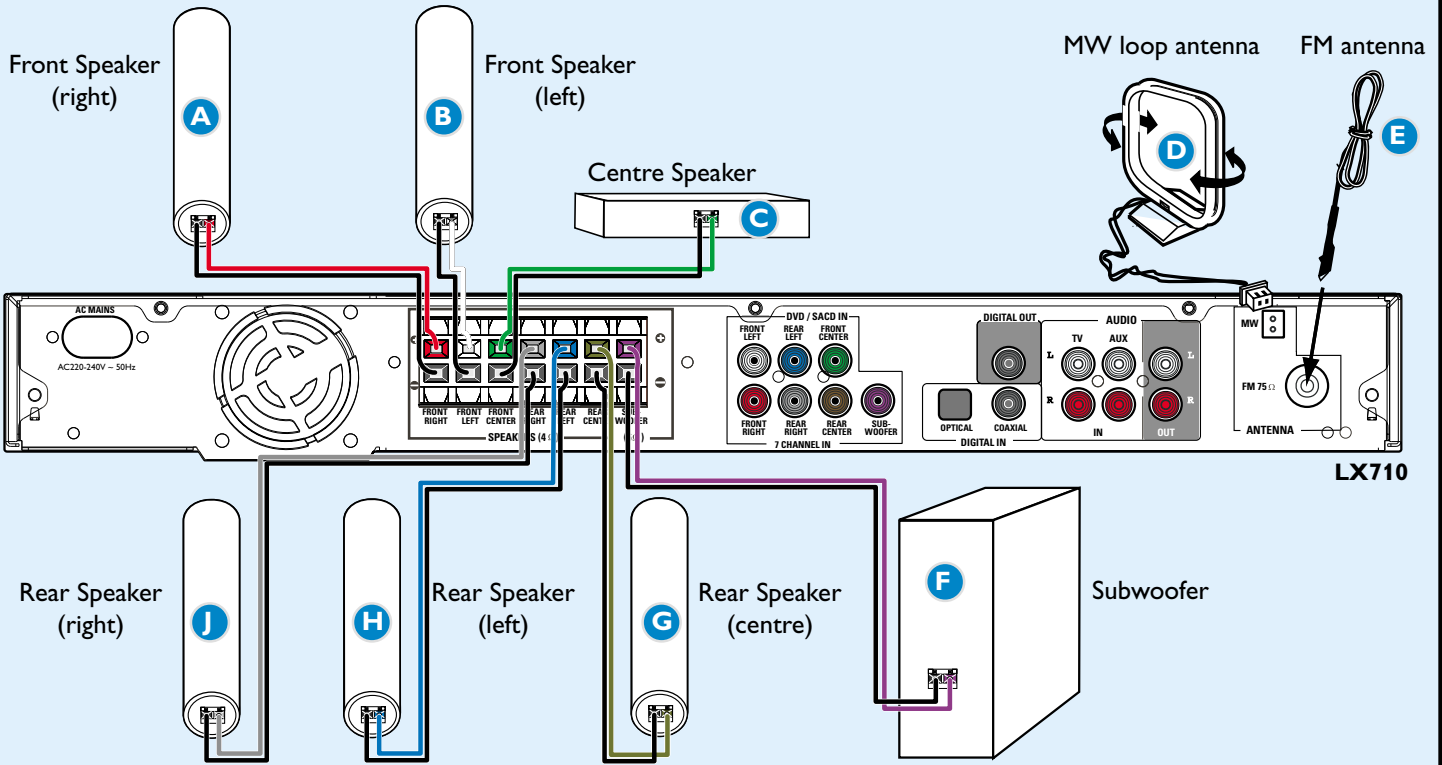
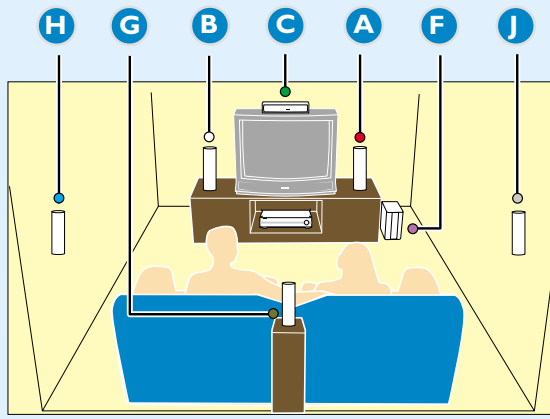

## Connecting to a TV

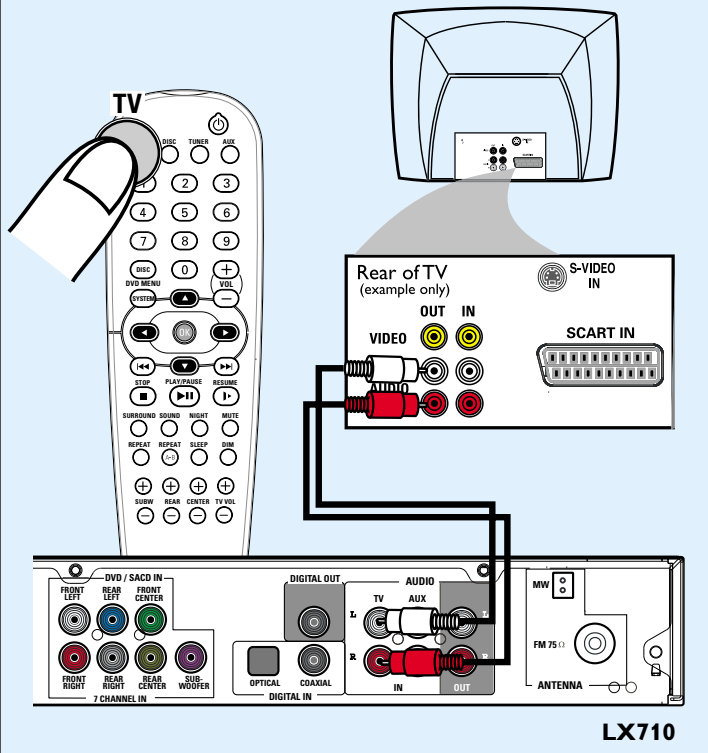

## Connecting to a CD Recorder

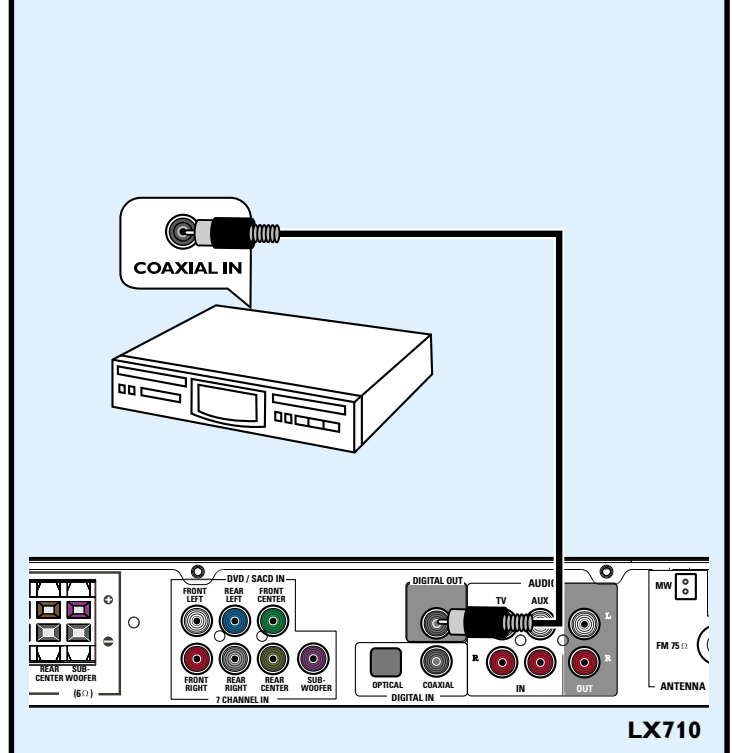

## Connecting to a VCR

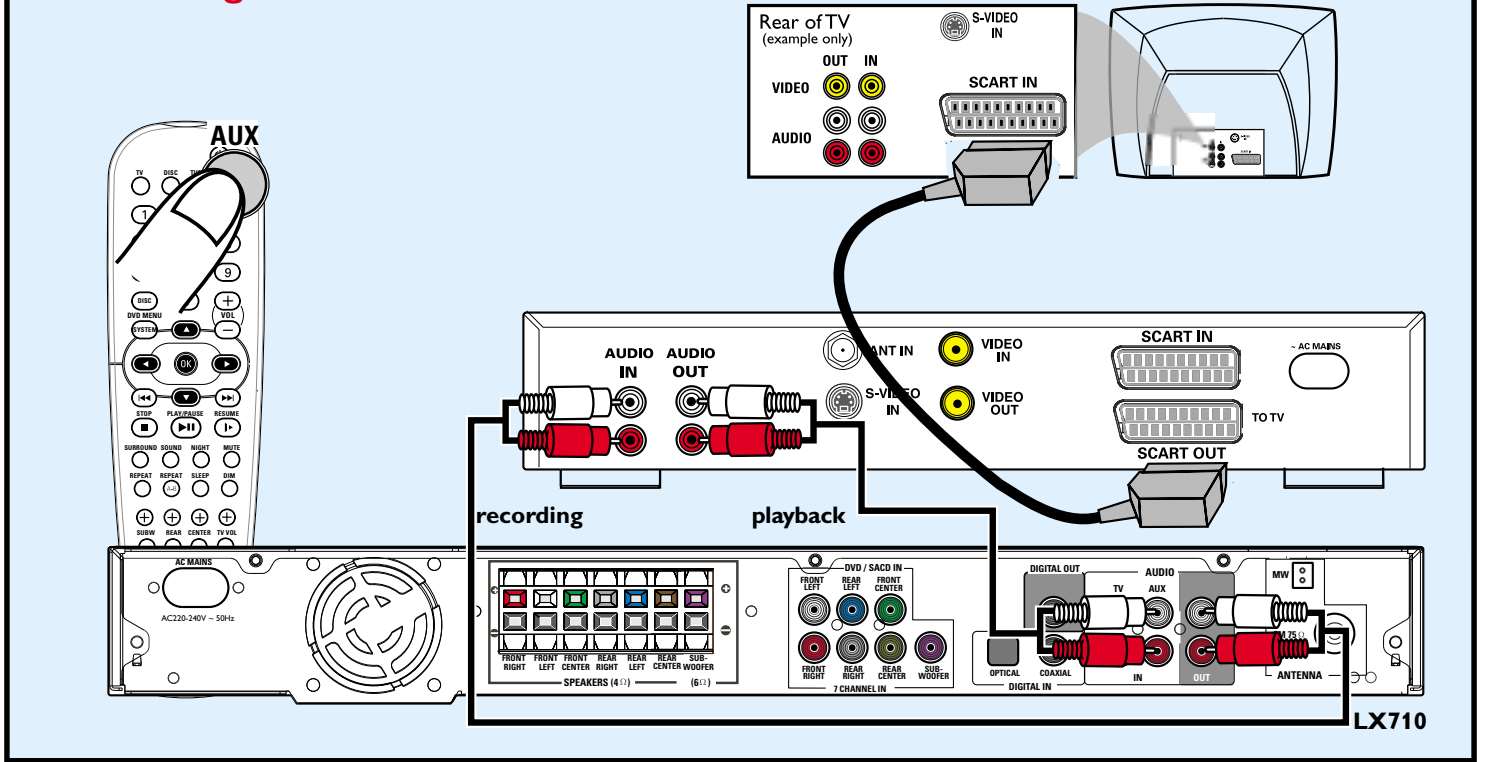

## Connecting to a DVD player

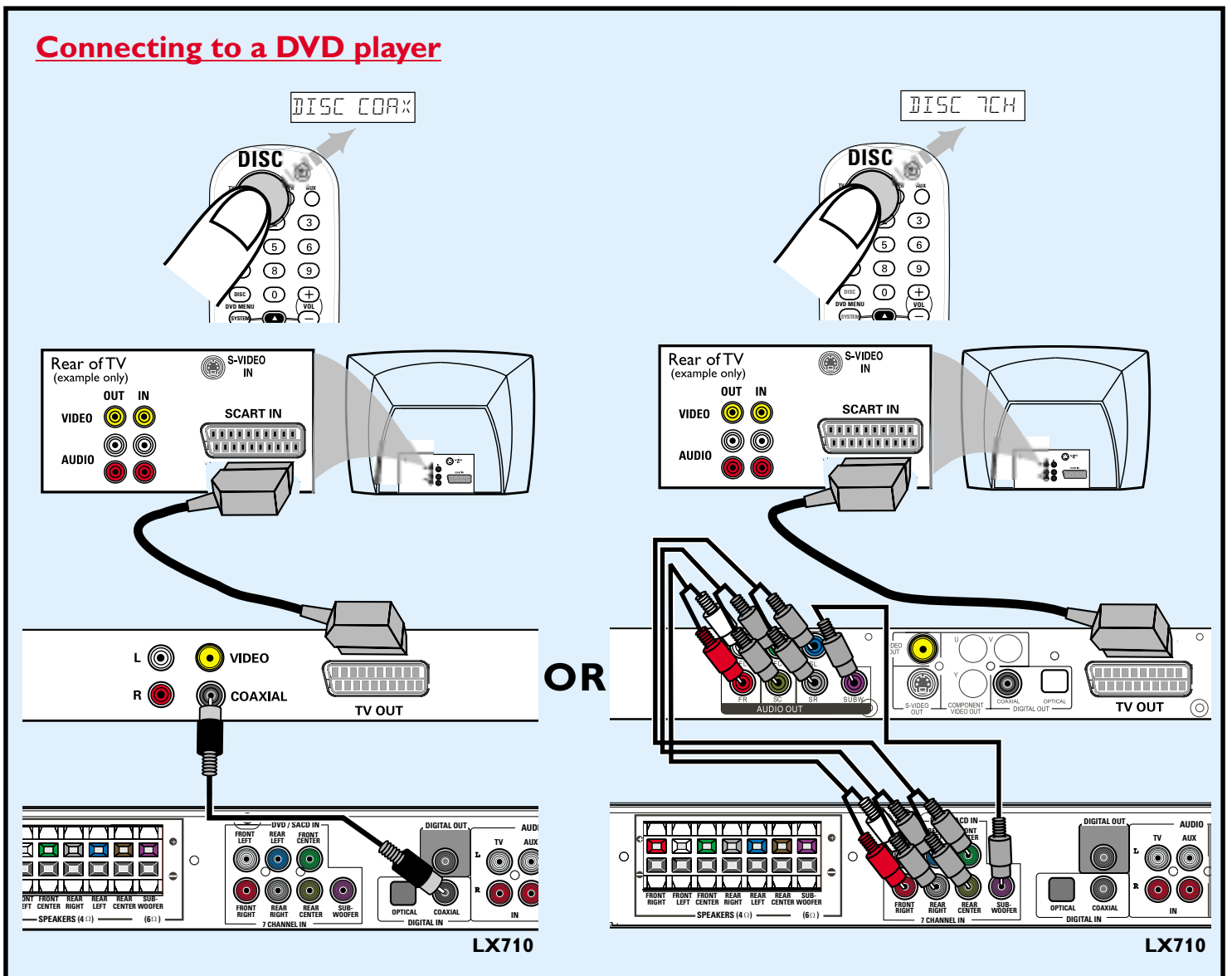

Detailed playback features and additional functions are described in the accompanying owner's manual.