

DVD Video/SACD Home Theatre System

LX8500W

User manual



PHILIPS

Index

English 4

English

中文(简体) 46

中文(简体)

中文(繁體) 87

中文(繁體)

Bahasa Melayu 128

Bahasa Melayu

Contents

General Information

Supplied accessories	6
Care and safety information	6

Connections

Step 1: Assemble the speakers	7
Step 2: Placing the speakers and AV subwoofer	7
Step 3: Connecting DVD system, AV subwoofer and front speakers	8
Step 4: Connecting wire-less rear speakers	8
Step 5: Connecting TV	9
Using Composite Video jack	9
Using S-Video jack	9
Step 6: Connecting a Progressive ScanTV	10
Using Component Video jacks (Y Pb Pr)	10
Step 7: Connecting FM/MW antennas ...	10
Step 8: Connecting the power cord	11

Connections (optional)

Connecting a VCR or Cable/Satellite Box	12
Viewing and listening to the playback	12
Using the VCR for recording DVD playback	12
Connecting digital audio equipment	13
Listening to the playback	13

Functional Overview

Remote Control	14–15
Top and front panel	16

Getting Started

Step 1: Inserting batteries into the remote control	17
Using the remote control to operate the system	17
Step 2: Setting the TV	17
Selecting the colour system that corresponds to your TV	18
Setting the TV Display	18
Step 3: Setting language preferences	19
On-Screen Display (OSD) language .	19
Audio, Subtitle and Disc menu languages	19
Step 4: Setting the speakers' channels ..	20

Disc Operations

Playable discs	21
Playing discs	21
Auto Eco Power standby mode	22
Basic playback controls	22
Selecting various repeat/shuffle functions	22
Repeat play mode	22
Repeating a section within a chapter/track	22
Other operations for video playback (DVD/VCD/SVCD)	23
Using the Disc Menu	23
Display the disc information and current status	23
Zooming in	24
Resuming playback from the last stopped point	24
Advancing by frame	24
Changing sound track language	24
Changing subtitle language (DVD only)	24
Viewing from another angle (DVD only)	24
Selecting a title (DVD only)	25
Playback Control (PBC) (VCD only)	25

Contents

English

Playing MP3/JPEG/DivX/MPEG-4 disc	26
Playing MP3 music and JPEG picture simultaneously	26
Playing Super Audio CD (SACD)	27
Special features for picture disc playback	27
Preview Function	27
Zoom picture	27
Playback with multi-angles	27
Scan Effect	27

DVD Setup Menu Options

General Setup Menu	28
Locking/Unlocking the disc for viewing	28
Programming disc tracks (not for Picture CD/MP3/SACD)	28–29
OSD language	29
Screen Saver – turning on/off	29
DivX(R) VOD registration code	29
Audio Setup Menu	30
Setting the analogue output	30
Speaker Setup	30
CD Upsampling	30
Night mode – turning on/off	31
Video Setup Menu	31
TV Type	31
TV Display	31
Progressive function-turning on/off ..	32
Picture Setting	32–33
Preference Setup Menu	33
Audio, Subtitle, Disc Menu	33
Restricting playback by Parental Control	33–34
PBC	34
MP3/JPEG Navigator – turning on/off	34
Changing the Password	35
Setting the DivX Subtitle	35
Restoring to original settings	35

Tuner Operations

Tuning to radio stations	36
Presetting radio stations	36
Using the Plug and Play	36
Automatic presetting	37
Manual presetting	37
Selecting a preset radio station	37
Deleting a preset radio station	37
Changing tuning grid	37

Sound Controls

Selecting surround sound	38
Selecting digital sound effects	38
Adjusting the Bass/Treble level	38

Volume Control and Other Functions

Switching on/off	39
Switching to an active mode	39
Switching to Eco Power standby mode	39
Volume Control	39
Dimming system's display screen	39
Using the remote to operate your 'Philips' television	39
Changing wire-less rear speakers transmission channel	40
Recording to an external device	40
Setting the Sleep timer	40

Specifications

Troubleshooting	42–43
-----------------------	-------

Glossary

Language Code	171
---------------------	-----

General Information

Supplied accessories

Composite video cable (yellow)



Audio cables (red/white)

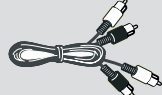

FM wire antenna



MW loop antenna



Speaker cables with different coloured jacks

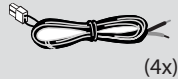

Remote control and two batteries (12nc: 3139 258 70051)

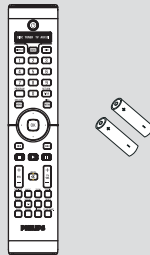

AC power cable



DVD system cable cover

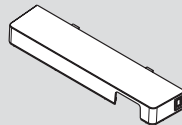

Speaker stands

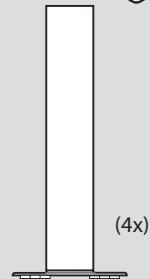

Care and safety information

Avoid high temperatures, moisture, water and dust

– Do not expose the system, batteries or discs to humidity, rain, sand or excessive heat (caused by heating equipment or direct sunlight). Always keep the disc tray closed to avoid getting dust on the lens.

Avoid condensation problem

– The lens may cloud over when the player is suddenly moved from cold to warm surroundings, making it impossible to play a disc. Leave the player in the warm environment until the moisture evaporates.

Do not block the vents

– Do not operate the DVD system/AV Subwoofer in an enclosed cabinet and allow about 10 cm (4 inches) of free space all around the player for adequate ventilation.

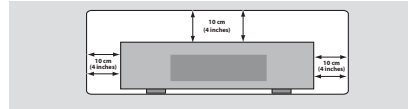

Care of disc

– To clean a CD, wipe it in a straight line from the centre toward the edge using a soft, lint-free cloth. Do not use cleaning agent, as they may damage the disc.

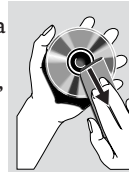

– Write only on the printed side of a CD-R/CD-RW and only with a soft felt-tipped pen.
– Handle the disc by its edge, do not touch the surface.

Care of the cabinet

– Use a soft cloth slightly moistened with a mild detergent solution. Do not use a solution containing alcohol, spirits, ammonia or abrasives.

Finding a suitable location

– Place the player on a flat, hard, stable surface.

Connections

English

Step 1: Assemble the speakers

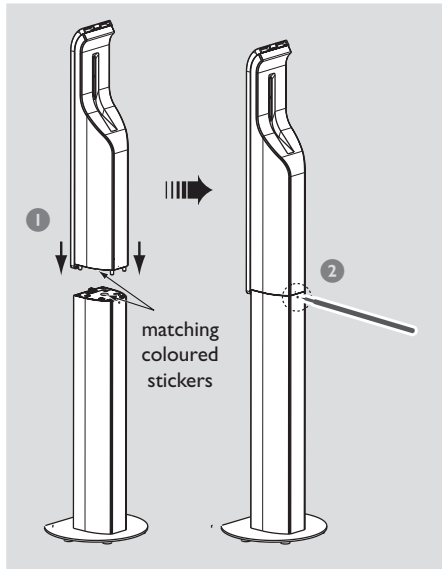

- 1 Look for the matching color sticker at the bottom of the speakers and on top of the speaker stands before attaching them.
- 2 If you want to disconnect speaker from the speaker stand, use a sharp end object (e.g. pen) to slot into the small hole at the rear of the speaker stand while pulling up the speaker.

Helpful Hints:

- Red colour stickers for front right and white colour stickers for front left.
- Grey colour stickers for rear right and blue colour stickers for rear left.

Step 2: Placing the speakers and AV subwoofer

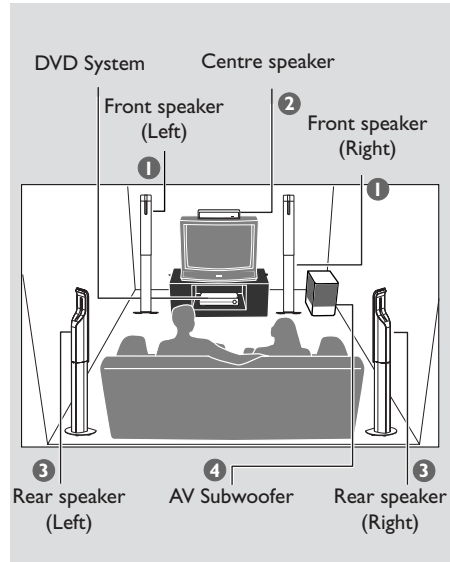

For best possible surround sound, all the speakers (except AV subwoofer) should be placed at the same distance from the listening position.

- 1 Place the front left and right speakers at equal distances from the TV and at an angle of approximately 45 degrees from the listening position.
- 2 Place the centre speaker above the TV or the DVD system so that the centre channel's sound is localised.
- 3 Place the rear speakers at normal listening ear level facing each other or hang on the wall.
- 4 Place the AV subwoofer on the floor near the TV.

Helpful Hints:

- To avoid magnetic interference, do not position the front speakers too close to your TV.
- Allow adequate ventilation around the DVD system/AV subwoofer.

Connections

Step 3: Connecting DVD system, AV subwoofer and front speakers

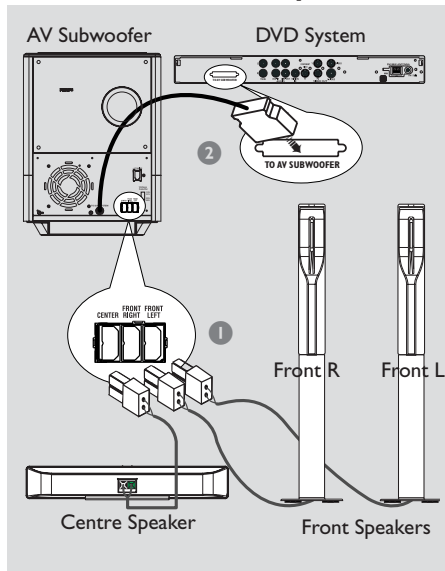

- 1 Use the supplied speaker cables to connect the FRONT R (red), FRONT L (white) and CENTER (green) speakers to the rear of the AV subwoofer by matching the colours of the jacks.
- 2 Connect the AV subwoofer with the DVD system by plugging in the inter-connect cable from the AV subwoofer to the **TO AV SUBWOOFER** jack at the rear of the DVD system.

Helpful Hints:

- Ensure that the speaker cables are correctly connected. Improper connections may damage the system due to short-circuit.
- To prevent unwanted noise, do not place the AV subwoofer too close to the DVD system, AC power adaptor, TV or other radiation sources.

Step 4: Connecting wire-less rear speakers

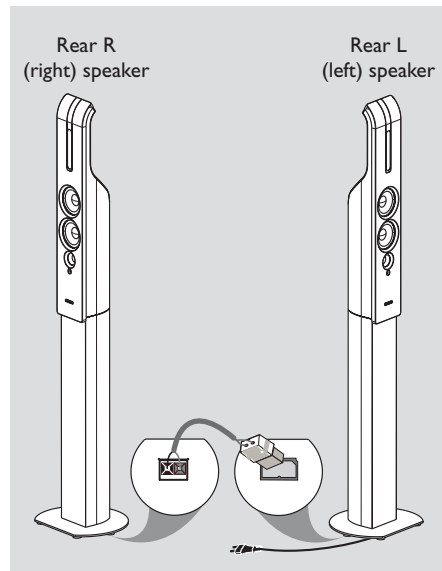

- The rear speaker stands (grey and blue colour stickers) are equipped with a wire-less receiver that receives audio signals from the DVD system. The wire-less rear speakers provide a surround sound entertainment experience without the scattered wires.
- 2 Use the supplied rear speaker cable (grey colour) to connect the rear left and right speakers. One end (easy connector) to the REAR L speaker and another end (click-fit) to the REAR R speaker.

Helpful Hints:

- To prevent unwanted noise, do not place the rear speakers too close to the DVD system, AC power adaptor, TV or other radiation sources.
- Do not connect the REAR L speaker to the power supply if not in use.

Connections

English

Step 5: Connecting TV

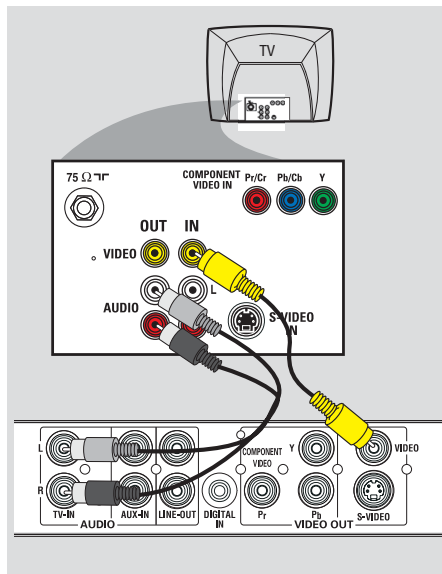

IMPORTANT!

- You only need to make one video connection from the following options, depending on the capabilities of your TV.
- Connect the DVD system directly to the TV.

Using Composite Video jack

- 1 Use the supplied composite video cable (yellow) to connect the DVD system's **VIDEO** jack to the video input jack (or labelled as A/V In, Video In, CVBS, Composite or Baseband) on the TV.
- 2 To hear the TV channels through this DVD system, use the supplied audio cables (white/red) to connect **AUDIO-TV IN** jacks to the corresponding AUDIO OUT jacks on the TV.

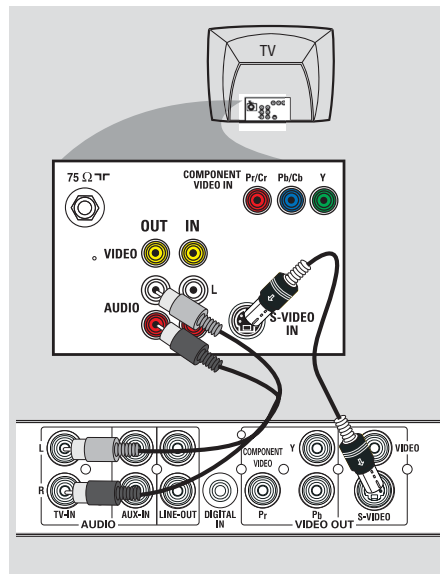

IMPORTANT!

- S-Video connection provides better picture quality. This option must be available on your TV.**

Using S-Video jack

- 1 Use an S-video cable (not supplied) to connect the DVD system's **S-VIDEO** jack to the S-Video input jack (or labelled as Y/C or S-VHS) on the TV.
- 2 To hear the TV channels through this DVD system, use the supplied audio cables (white/red) to connect **AUDIO-TV IN** jacks to the corresponding AUDIO OUT jacks on the TV.

Connections

Step 6: Connecting a Progressive Scan TV

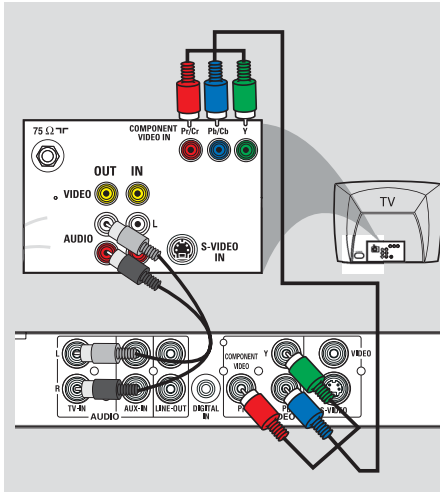

IMPORTANT!
The progressive scan video quality is only available when using **Y Pb Pr** connection and a progressive scan TV is required.

Using Component Video jacks (Y Pb Pr)

- 1 Use the component video cables (red/blue/green - not supplied) to connect the DVD system's **Y Pb Pr** jacks to the corresponding component video input jacks (or labelled as Y Pb/Cb Pr/Cr or YUV) on the TV.
- 2 To hear the TV channels through this DVD system, use the supplied audio cables (white/red) to connect **AUDIO-TV IN** jacks to the corresponding **AUDIO OUT** jacks on the TV.
- 3 Activate the progressive scan function, see page 32.

Step 7: Connecting FM/MW antennas

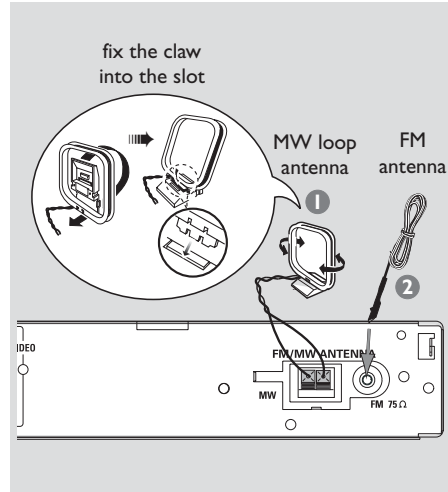

- 1 Connect the supplied MW loop antenna to the **MW** jack. Place the MW loop antenna on a shelf or attach it to a stand or wall.
- 2 Connect the supplied FM antenna to the **FM** jack. Extend the FM antenna and fix its ends to the wall.

For better FM stereo reception, connect an external FM antenna (not supplied).

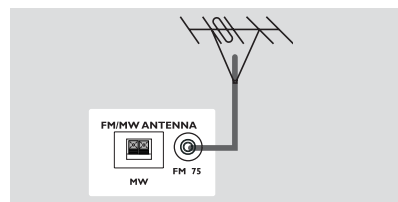

Helpful Hints:

- Adjust the position of the antennas for optimal reception.
- Position the antennas as far as possible from your TV, VCR or other radiation source to prevent unwanted interference.

Step 8: Connecting the power cord

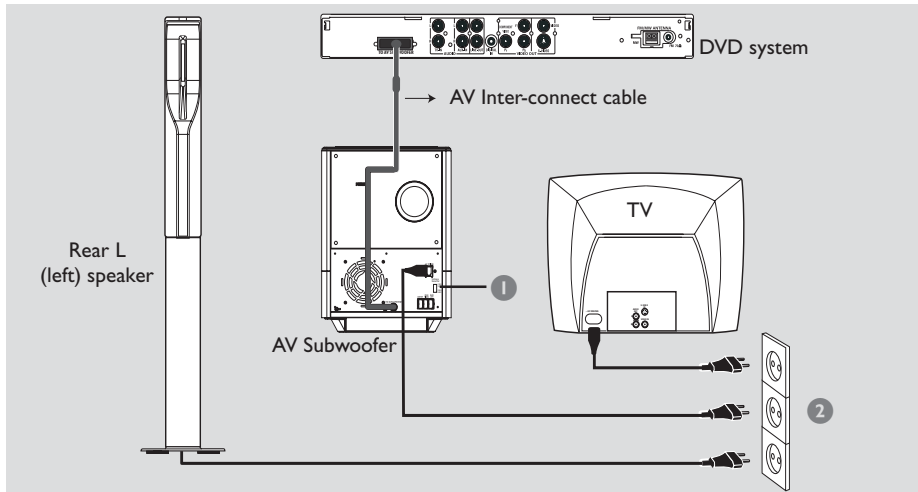

After everything is connected properly,

- 1 Set the **VOLTAGE SELECTOR** to the local power line voltage.
- 2 Plug in the AC power cord to the power outlet.

The red **STANDBY LED** on the DVD system will light up. Never make or change any connections with the power switched on.

IMPORTANT!

Remove the **REAR L** speaker power cord from the power supply if not in use to avoid unwanted noise.

Manage the cables neatly

This DVD system comes with a cable cover, it allows you to organise all the connecting cables neatly through the opening and you can use the velcro strip that attached to the inter-connect cable to tie up rest of the cables together.

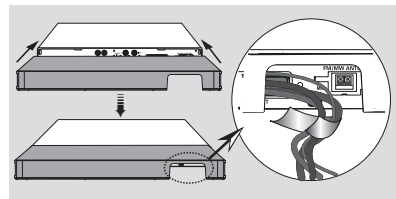

Helpful Hint:

– Refer to the type plate on the rear of the AV subwoofer for identification and supply ratings.

Connections (Optional)

Connecting a VCR or Cable/Satellite Box

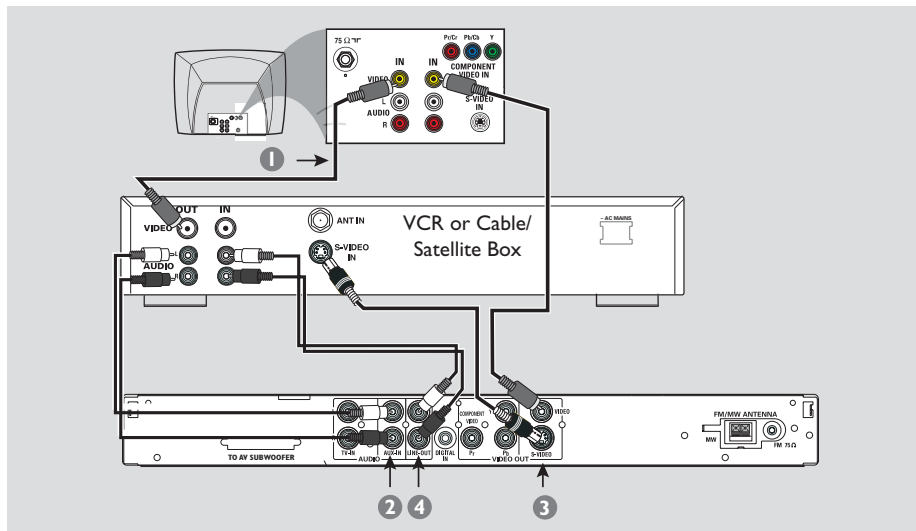

Viewing and listening to the playback

- 1 Connect the VCR or Cable/Satellite Box to the TV as shown.
- 2 Connect the DVD system's **AUX IN (R/L)** jacks to the **AUDIO OUT** jacks on the VCR or cable/satellite box.

Before starting operation, press **SOURCE** to select "AUX" in order to activate the input source.

Using the VCR for recording DVD playback

Some DVDs are copy-protected. You cannot record or dub protected discs using a VCR.

- 3 Connect the DVD system's **S-VIDEO** jack to the **S-VIDEO IN** jack on the VCR.
- 4 Connect the DVD system's **LINE OUT (R/L)** jacks to the **AUDIO IN** jacks on the VCR.

This will allow you to make analogue stereo (two channel, right and left) recordings.

To view DVD playback while recording,

you must connect the DVD system to your TV using **VIDEO** (as shown above) connection.

Connections (Optional)

Connecting digital audio equipment

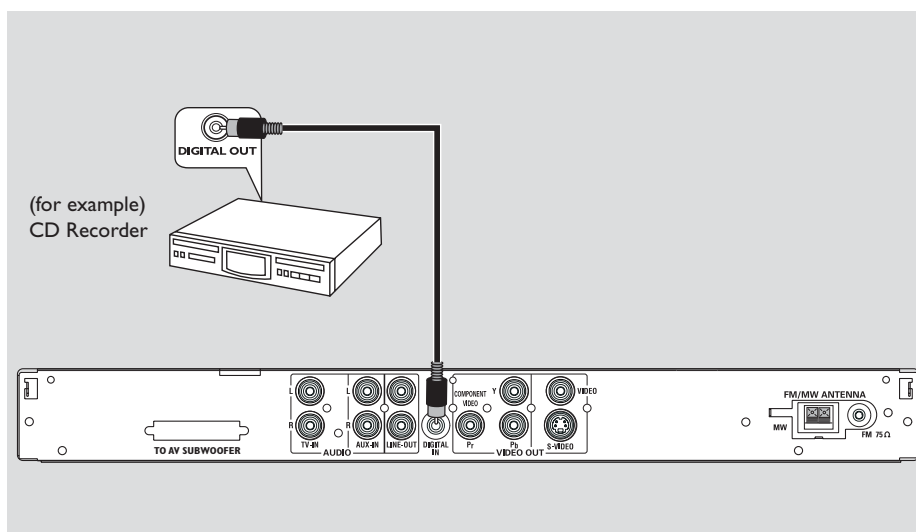

English

Listening to the playback

- Connect the DVD system's **DIGITAL IN** jack to the DIGITAL OUT jack on a digital audio device.

Before starting operation, press **SOURCE** to select "DIGI IN" in order to activate the input source.

Helpful Hints:

- Some DVDs are copy-protected. You cannot record the disc through a VCR or digital recording device.
- You cannot hear or record the SACD or MP3-CD playback if you use the digital connection.
- For your playback through DIGITAL IN connection, set the digital output of that player to PCM format.
- Always refer to the owner's manual of the other equipment for complete connection and use details.

Functional Overview

Remote control

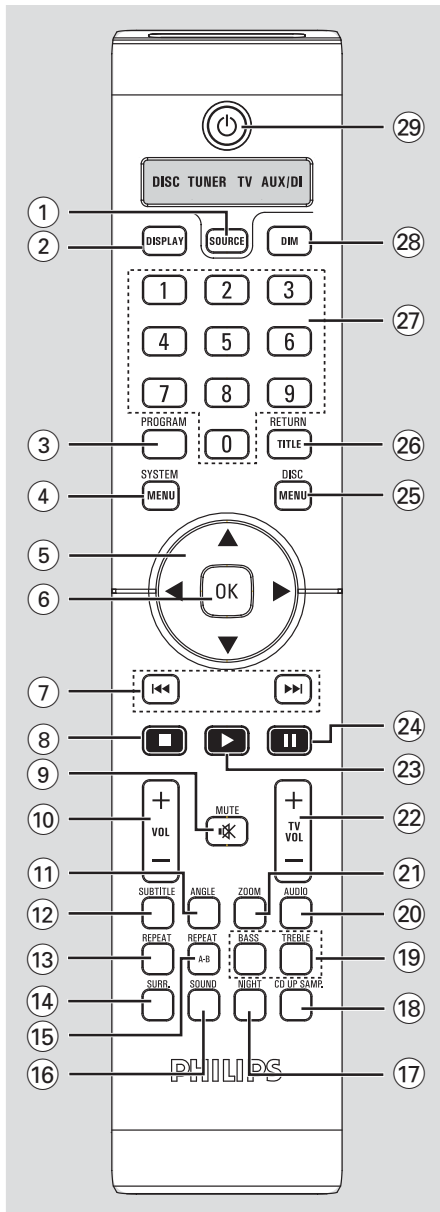

① SOURCE

- Selects the relevant active source mode: DISC, TUNER (FM/MW), TV or AUX/DI.

② DISPLAY

- Displays the current status or disc information.

③ PROGRAM

- DISC: starts programming.
- TUNER: starts *automatic/ manual preset programming.

④ SYSTEM MENU

- Enters or exits system setup menu.

⑤ Cursor

- Selects movement direction in the menu.
- TUNER: press left or right to select a preset radio station.
- TUNER: up or down to select auto tuning.

⑥ OK

- Confirms a selection.

⑦ ◀◀ / ▶▶

- DISC: *searches backward/forward or selects a track.
- TV: selects previous/next channel (Philips TV only).
- TUNER: tunes the radio frequency up/down.

⑧ ■

- Exits an operation.
- DISC: stops playback.
- TUNER: *erases a preset radio station.

⑨ MUTE

- Mutes or restores the volume.

⑩ VOL + -

- Adjusts the volume level.

* = Press and hold the button for more than two seconds.

Functional Overview

- ⑪ **ANGLE**
 - Select a DVD disc camera angle (if available).
- ⑫ **SUBTITLE**
 - Selects a subtitle language.
- ⑬ **REPEAT**
 - Selects various repeat modes.
- ⑭ **SURR**
 - DISC: selects multichannel surround or stereo mode.
 - TUNER: selects stereo or mono signal.
- ⑮ **REPEAT A-B**
 - Repeats a specific section on a disc.
- ⑯ **SOUND**
 - Selects a sound effect.
 - *Selects another transmission channel for the rear wire-less speakers.
- ⑰ **NIGHT** (in DVD mode only)
 - Optimises the dynamics of the sound output.
- ⑱ **CD UP SAMP.**
 - Converts music CD to a higher sampling rate for better sound quality.
- ⑲ **BASS/TREBLE**
 - Selects BASS (low tone) or TREBLE (high tone) sound mode and use the VOLUME control to change the tone level.
- ⑳ **AUDIO**
 - Selects an audio language (DVD) or an audio channel (CD).
- ㉑ **ZOOM**
 - Enlarges a picture on the TV screen.
- ㉒ **TVVOL + –**
 - Adjusts TV volume (Philips TV only).
- ㉓ **▶**
 - DISC: starts playback.
- ㉔ **⏸**
 - DISC: pauses playback.
- ㉕ **DISC MENU**
 - Enters or exits disc contents menu.
 - For VCD version 2.0 only; In stop mode, turns on/off playback control (PBC) mode. During playback, returns to main menu.
- ㉖ **RETURN/TITLE**
 - To go back to previous menu.
 - Displays the disc's Title menu (if available).
- ㉗ **Numeric Keypad (0-9)**
 - Enters a track/title number of the disc.
 - Enters a number of a preset radio station.
- ㉘ **DIM**
 - Selects different levels of brightness for display panel.
 - *Sets the sleep timer function.
- ㉙ **⏻**
 - Switches to Eco Power standby mode.

* = Press and hold the button for more than two seconds.

Functional Overview

Top and front panel

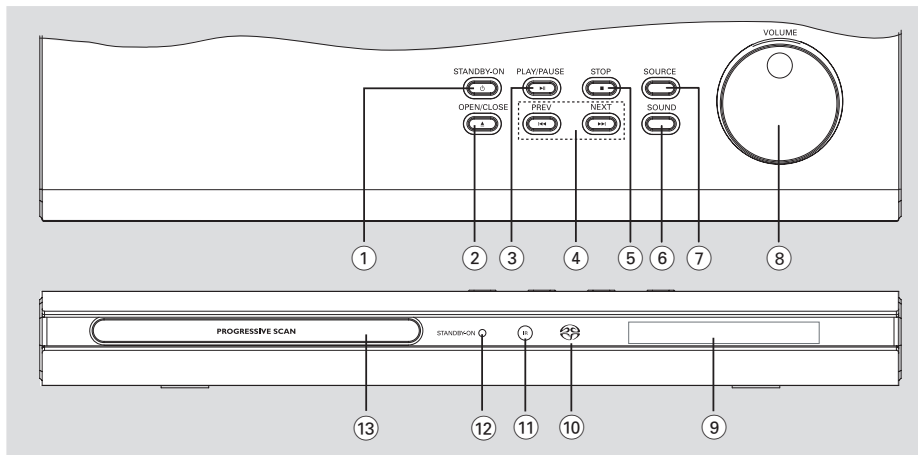

- ① **STANDBY ON (⏻)**
- Switches to Eco Power standby mode or turns on the system.
- ② **OPEN/CLOSE ▲**
- Opens/Closes the disc tray.
- ③ **▶ II PLAY/PAUSE**
- DISC: starts/pauses playback.
 - TUNER: starts preset radio station installation in Plug & Play mode.
- ④ **◀◀ PREV / NEXT ▶▶**
- DISC: *searches backward/forward or selects a track.
 - TV: selects previous/next channel (Philips TV only).
 - TUNER: tunes the radio frequency up/down.
- ⑤ **■ STOP**
- Exits an operation.
 - DISC: stops playback.
 - TUNER: *erases a preset radio station.
- ⑥ **SOUND**
- Selects a sound effect.
 - *Selects another transmission channel for the rear wire-less speakers.
- ⑦ **SOURCE**
- Selects the relevant active source mode: DISC, TUNER (FM/MW), TV or AUX/DI.
- ⑧ **VOLUME**
- Adjusts the volume level.
- ⑨ **System display panel**
- ⑩ **SACD indicator**
- Lights up when playing Super Audio CD.
- ⑪ **iR**
- Point the remote control towards this sensor.
- ⑫ **STANDBY ON indicator**
- Lights up when in Eco Power standby mode.
- ⑬ **Disc tray**

* = Press and hold the button for more than two seconds.

Getting Started

Step 1: Inserting batteries into the remote control

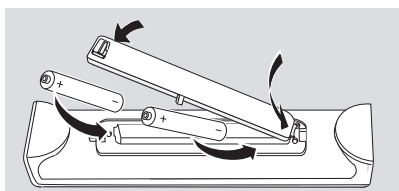

- 1 Open the battery compartment.
- 2 Insert two batteries type R06 or AA, following the indications (+ -) inside the compartment.
- 3 Close the cover.

Using the remote control to operate the system

- 1 Aim the remote control directly at the remote sensor (iR) on the front panel.
- 2 Press **SOURCE** button on the remote to select the mode you wish to control (for example TV, DISC). The selected source mode will light up on the LED panel for a few seconds.
- 3 Then select the desired function (for example \blacktriangleright , $\blacktriangleleft\blacktriangleleft$, $\blacktriangleright\blacktriangleright$).



Step 2: Setting the TV

IMPORTANT!

Make sure you have completed all the necessary connections. (See page 9 “Connecting TV”)

- 1 Press **SOURCE** control until “**BISC**” appears on the display panel.
- 2 Turn on the TV and set to the correct video-in channel. You should see the blue DVD background screen on the TV.
→ Usually this channel is between the lowest and highest channels and may be called FRONT, A/V IN, VIDEO. See your TV manual for more details.
→ Or, you may go to channel 1 on your TV, then press the Channel down button repeatedly until you see the Video In channel.
→ Or, the TV remote control may have a button or switch that chooses different video modes.

CAUTION!

- Remove batteries if they are exhausted or if the remote is not to be used for a long time.
- Do not use old and new or different types of batteries in combination.
- Batteries contain chemical substances, so they should be disposed of properly.

Getting Started

Selecting the colour system that corresponds to your TV

In order for a DVD to play on this DVD system, the colour system of the DVD, the TV and the DVD player should match. Before changing the TV system, determine the colour system of your TV.

- 1 In disc mode, press **SYSTEM MENU**.
- 2 Press **▶** repeatedly to select {VIDEO SETUP PAGE}.
- 3 Press **▲▼** to highlight {TV TYPE}, then press **▶**.



- 4 Press **▲▼** to highlight one of the options below:

PAL – Select this if the connected TV has the PAL colour system. It will change the video signal of an NTSC disc and output it to PAL format.

NTSC – Select this if the connected TV has the NTSC colour system. It will change the video signal of a PAL disc and output it to NTSC format.

MULTI – Select this if the connected TV is compatible with both NTSC and PAL (multi-system). The output format will be in accordance with the video signal of the disc.

- 5 Select a setting and press **OK**.
 - Follow the instructions shown on the TV to confirm the selection (if any).
 - If a blank/distorted TV screen appears, wait for 15 seconds for auto recovery.

Setting the TV Display

Set the aspect ratio of the DVD Player according to the TV you have connected. The format you select must be available on the disc. If it is not, the setting for TV display will not affect the picture during playback.

- 1 In disc mode, press **SYSTEM MENU**.
- 2 Press **▶** repeatedly to select {VIDEO SETUP PAGE}.
- 3 Press **▲▼** to highlight {TV DISPLAY}, then press **▶**.

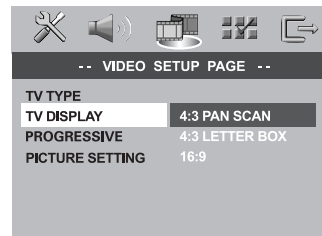

- 4 Press **▲▼** to highlight one of the options below:

4:3 PAN SCAN –

Select this if you have a conventional TV and want both sides of the picture to be trimmed or formatted to fit your TV screen.

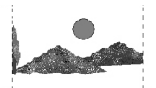

4:3 LETTER BOX –

Select this if you have a conventional TV. In this case, a wide picture with black bands on the upper and lower portions of the TV screen will be displayed.



16:9 – Select this if you have a wide-screen TV.

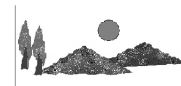

- 5 Select a setting and press **OK**.

TIPS: To return to the previous menu, press **◀**.
To remove the menu, press **SYSTEM MENU**.

Getting Started

English

Step 3: Setting language preferences

You can select your preferred language settings so that this DVD system will automatically switch to the language for you whenever you load a disc. If the language selected is not available on the disc, the disc's default setting language will be used instead. The OSD (on-screen display) language for the system menu will remain as you set it, regardless of various disc languages.

On-screen display (OSD) language

- 1 In disc mode, press **SYSTEM MENU**.
- 2 Press **▶** to select {GENERAL SETUP PAGE}.
- 3 Press **▲▼** to highlight {OSD LANGUAGE}, then press **▶**.

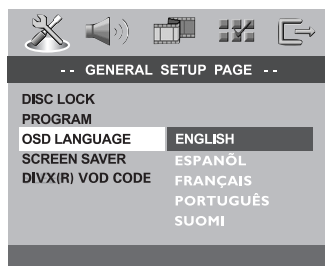

- 5 Press **▲▼** to select a language and press **OK** to confirm.

Audio, Subtitle and Disc menu languages

- 1 Press **■** twice to stop playback (if any), then press **SYSTEM MENU**.
- 2 Press **▶** repeatedly to select {PREFERENCE PAGE}.
- 3 Press **▲▼** to highlight one of the options below at a time, then press **▶**.
 - {AUDIO} (disc's soundtrack)
 - {SUBTITLE} (disc's subtitles)
 - {DISC MENU} (disc's menu)

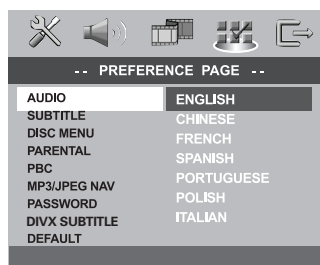

- 4 Press **▲▼** to select a language and press **OK** to confirm.

If the language you want is not in the list, then select {OTHERS}.

Use the **numeric keypad (0-9)** on the remote to enter the 4-digit language code 'XXXX' (see page 171) and press **OK** to confirm.

- 5 Repeat steps 3~4 for other settings.

TIPS: To return to the previous menu, press **◀**.
To remove the menu, press **SYSTEM MENU**.

Getting Started

Step 4: Setting the speakers' channels

You can adjust the delay times (centre and surround only) and volume level for individual speakers. These adjustments let you optimise the sound according to your surroundings and setup.

IMPORTANT!

- Press **SURR** button on the remote to select **Multi-channel surround mode** before adjusting the speaker settings.
- In case of sound distortion, press and hold the **SOUND** button to select another transmission channel for the wire-less rear speakers.

- 1 Press **■** to stop playback, then press **SYSTEM MENU**.
- 2 Press **▶** repeatedly to select {AUDIO SETUP PAGE}.
- 3 Press **▲▼** to highlight {SPEAKER SETUP}, then press **▶**.

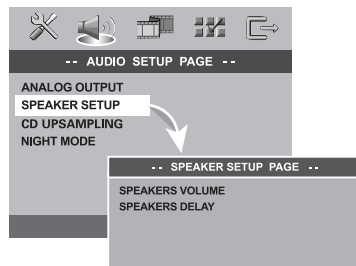

- 4 Enter its submenu by pressing **▶**.
- 5 Press **▲▼** to highlight one of the options below at a time, then press **▶**.

{SPEAKERS VOLUME} – Volume level setting for individual speakers (-6dB ~ +6dB).

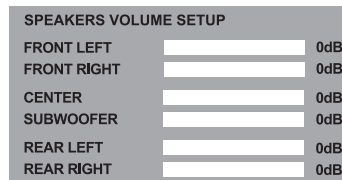

{SPEAKERS DELAY} – Delay times setting in relation to the listening position/distance for center and surround speakers.

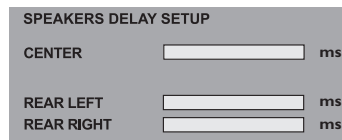

- 6 Press **◀▶** to adjust the setting that best suit your surround sound needs.
- 7 Press **OK** to confirm.

Helpful Hints:

- Use the longer delay time settings when the surround speakers are closer to the listener than the front speakers.
- The test tone will be automatically generated to help you judge the sound level of each speaker.

TIPS: To return to the previous menu, press **◀**.
To remove the menu, press **SYSTEM MENU**.

Disc Operations

English

IMPORTANT!

- If the inhibit icon (ø or X) appears on the TV screen when a button is pressed, it means the function is not available on the current disc or at the current time.
- DVD discs and players are designed with regional restrictions. Before playing a disc, make sure the disc is for the same zone as your player.
- Do not push on the disc tray or put any objects other than discs on the disc tray. Doing so may cause the disc player to malfunction.

Playable discs

Your DVD home cinema system will play:

- Digital Versatile Discs (DVDs)
- Video CDs (VCDs)
- Super-Video CDs (SVCDs)
- Super Audio CDs (SACDs)
- Finalised Digital Video Discs + Recordable[Rewritable] (DVD+R[W])
- Audio Compact Discs (CDs)
- MP3 discs, picture (Kodak, JPEG) files on CD-R(W).
 - JPEG/ISO 9660 format
 - Maximum 30 characters display
 - Supported sampling frequencies : 32 kHz, 44.1 kHz, 48 kHz
 - Supported Bit-rates : 32~256 (kbps), variable bit rates
- MPEG-4 files on CD-R[W]:
 - Simple profile
 - Advanced simple profile (640-480)
- DivX disc on CD-R[W]/DVD+R[W]:
 - DivX 3.11, 4.x and 5.x
 - GMC (Global Motion Compensation) and QP (Quarter Pixel) not supported.



TIPS: The operating features described here might not be possible for certain discs. Always refer to the instructions supplied with the discs.

Region Codes

DVDs must be labelled for **ALL** regions or **Region 3** in order to play on this DVD system. You cannot play discs that are labelled for other regions.



Helpful Hints:

- It may not be possible to play CD-R/RW or DVD-R/RW in all cases due to the type of disc or condition of the recording.
- If you are having trouble playing a certain disc, remove the disc and try a different one. Improperly formatted discs will not play on this DVD system.

Playing discs

- 1 Press **SOURCE** control until “DISC” appears on the display panel.
 - The DISC LED on the remote will light up for a few seconds.
- 2 Turn on the TV power and set to the correct Video In channel. (See page 17 “Setting the TV”).
 - You should see the blue DVD background screen on the TV.
- 3 Press **OPEN/CLOSE** once to open the disc tray and load a disc, then press the same button again to close the disc tray.
 - Make sure the disc label is facing up. For double-sided discs, load the side you want to play face up.
- 4 Playback will start automatically.
 - If a disc menu shows on the TV, see page 23 “Using the Disc Menu”.
 - If the disc is locked by parental control, you must enter your six-digit password. (See pages 33-35).

Disc Operations

Auto Eco Power standby mode

This is a power-saving feature, the system will automatically switch to Eco Power standby mode if you do not press any buttons within 30 minutes after a disc has stopped playing.

Basic playback controls

Pausing playback

- During playback, press **II** (▶II).
→ To resume normal playback, press ▶ (or ▶II).

Selecting another track/chapter

- Press ◀◀ / ▶▶ or use the **numeric keypad (0-9)** to key in a track/chapter number.
→ If repeat mode is active, pressing ◀◀ / ▶▶ will replay the same track/chapter.

Searching backward/forward

- Press and hold ◀◀ / ▶▶. To resume normal playback, press ▶ (or ▶II).
→ While searching, pressing ◀◀ / ▶▶ again will decrease/increase the search speed.

Stopping playback

- Press ■.

Selecting various repeat/shuffle functions

Repeat play mode

- While playing a disc, press **REPEAT** continuously to choose a 'Play Mode'.

DVD

- RPT ONE (repeat chapter)
- RPT TT (repeat title)
- SHUFFLE (random play)
- RPT SHF (repeat shuffling)
- RPT OFF (repeat off)

VCD/SVCD/CD

- RPT ONE (repeat track)
- RPT ALL (repeat disc)
- SHUFFLE (random play)
- RPT SHF (repeat shuffling)
- RPT OFF (repeat off)

MP3/SACD/DivX

- RPT ONE (repeat track)
- RPT FLD (repeat folder)
- SHUFFLE (random play)
- RPT OFF (repeat off)

Helpful Hint:

– For VCD, repeat playback is not possible if the PBC mode is switched on.

Repeating a section within a chapter/track

- 1 While playing a disc, press **REPEAT A-B** at your chosen starting point.
- 2 Press **REPEAT A-B** again at your chosen end point.
→ The section A and B can be set only within the same chapter/track.
→ The section will now repeat continuously.
- 3 To exit the sequence, press **REPEAT A-B**.

TIPS: The operating features described here might not be possible for certain discs. Always refer to the instructions supplied with the discs.

Disc Operations

Other operations for video playback (DVD/VCD/SVCD)

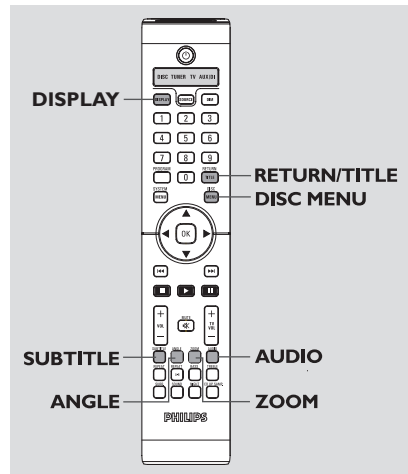

Using the Disc Menu

Depending on the disc, a menu may appear on the TV screen once you load in the disc.

To select a playback feature or item

- Use **◀▶▲▼** keys or **numeric keypad (0-9)** on the remote, then press **OK** to start playback.

To access or remove the menu

- Press **DISC MENU** on the remote.

Display the disc information and current status

It shows the disc information and its current status (for example, title or chapter number, elapsed playing time, audio/subtitle language). A number of operations can be done without interrupting disc playback.

- 1 During playback, press **DISPLAY**.
→ A list of available disc information appears on the TV screen.

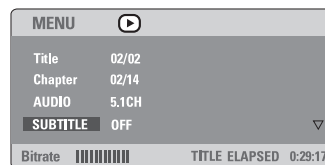

- 2 Press **▲▼** to view the information and press **OK** to access.
- 3 Use the **numeric keypad (0-9)** to input the number/time or press **▲▼** to make the selection, then press **OK** to confirm.
→ Playback will change to the chosen time or to the selected title/chapter/track.

TIPS: The operating features described here might not be possible for certain discs. Always refer to the instructions supplied with the discs.

Disc Operations

Zooming in

This function allows you to enlarge the picture on the TV screen and to pan through the enlarged picture.

- 1 During playback, press **ZOOM** repeatedly to select different zoom factor.
 - Use ◀▶▲▼ keys to move through the zoomed image.
 - Playback will continue.
- 2 Press **ZOOM** repeatedly to return to the original size.

Resuming playback from the last stopped point

Resume playback of the last 10 discs is possible, even if the disc was ejected or the power switched off.

- 1 Load one of the last played 10 disc.
 - "LOADING" appears.
- 2 Press ▶ (or ▶II) and the disc will be played back from the last stop point.

To cancel the resume mode

- In stop mode, press ■ again.

Advancing by frame

- 1 During playback, press II on the remote.
 - Play will pause and sound will be mute.
- 2 Press II again to select the next picture frame.
- 3 To resume normal playback, press ▶ (or ▶II).

Changing sound track language

This operation works only on DVDs with multiple soundtrack language, you can change the language you want while playing DVD.

- Press **AUDIO** repeatedly to select the available audio languages.

For VCD - changing the audio channel

- Press **AUDIO** repeatedly to select the available audio channels provided by the disc (STEREO, LEFT MONO, RIGHT MONO or MIX MONO).

Changing subtitle language (DVD only)

This operation works only on DVDs with multiple subtitle languages, you can change the language you want while playing DVD.

- Press **SUBTITLE** repeatedly to select different subtitle languages.

Viewing from another angle (DVD only)

If the disc contains sequences recorded from different camera angles, this allows you to view the picture from different angles.

- Press **ANGLE** repeatedly to select a desired angle.
 - Playback changes to the selected angle.

TIPS: The operating features described here might not be possible for certain discs. Always refer to the instructions supplied with the discs.

Disc Operations

English

Selecting a title (DVD only)

Some DVDs may contain several titles. If the disc has a title menu recorded on it, you can start playback from the selected movie title.

- 1 Press **RETURN/TITLE**.
→ The disc title menu appears on the TV screen.
- 4 Use **◀▶ ▲ ▼** keys or **numeric keypad (0-9)** to select a play option.
- 3 Press **OK** to confirm.

Playback Control (PBC) (VCD only)

PBC playback allows you to play Video CDs interactively, following the menu on the display. This function can also be accessed via the 'PREFERENCE PAGE' menu (see page 34).

For VCDs with Playback Control (PBC) feature (version 2.0 only)

- When play is stopped, press **DISC MENU** to toggle between 'PBC ON' and 'PBC OFF'.
 - If you select 'PBC ON', the disc menu (if available) will appear on the TV. Use **◀◀ / ▶▶** or numeric keypad (0-9) to select a play option and press **OK** to confirm.
 - If you select 'PBC OFF', the VCD will skip the index menu and playback directly from the beginning.

TIPS: The operating features described here might not be possible for certain discs. Always refer to the instructions supplied with the discs.

Disc Operations

Playing MP3/JPEG/DivX/ MPEG-4 disc

This player can playback DivX, MPEG-4, MP3, JPEG, VCD & SVCD files on a personally recorded CD-R/RW disc or commercial CD.

IMPORTANT!

You have to turn on your TV and set to the correct Video In channel. (See page 17 "Setting the TV").

- 1 Load a disc.
→ The disc reading time may exceed 30 seconds due to the complexity of the directory/file configuration.
→ The disc menu appears on the TV screen.



- 2 Press ▲▼ to select a desired folder and press **OK** to open the folder.
- 3 Press ▲▼ to select a track/file.
- 4 Press **OK** to confirm.
→ Playback will start from the selected file to the end of the folder.

During playback, you can;

- Press |◀◀ / ▶▶| to select another track/file in the current folder.
- To select another folder from the current disc, press ◀ to return to the root menu, then press ▲▼ to make your selection and press **OK** to confirm.

- Press **REPEAT** continuously to access different 'Play Mode'.
→ **REPEAT ONE**: one file being played repeatedly.
→ **REPEAT FOLDER/REPEAT ALL**: all files in one folder being played repeatedly.
→ **SHUFFLE**: all files in the current folder being played at random order.
- Press **II** to pause or ▶ (or ▶II) to resume playback.

Playing MP3 music and JPEG picture simultaneously

- 1 Load a MP3 disc that contains music and picture.
→ The disc menu appears on the TV screen.
- 2 Select an MP3 track and press ▶ (or ▶II) to start playback.
- 3 During MP3 music playback, select a picture folder from the TV screen and press ▶ (or ▶II).
→ The picture files will be played back until end of the folder.
- 4 To quit simultaneous playback, press **DISC MENU** followed by ■.

Helpful Hints:

- It may not be possible to play certain MP3/JPEG/DivX/MPEG-4 disc due to the configuration and characteristics of the disc or condition of the recording.
- It is normal to experience an occasional "skip" while listening to your MP3 disc.
- It is normal to experience an occasional pixelation during MPEG-4/DivX playback due to poor clarity of digital contents during internet downloading.
- For multi-session discs with different formats, only the first session will be available.

TIPS: The operating features described here might not be possible for certain discs. Always refer to the instructions supplied with the discs.

Disc Operations

Playing Super Audio CD (SACD)

There are three types of SACD discs : single layer, double layer or hybrid disc. The hybrid disc contains both Super Audio CD and standard audio CD layers, only the SACD layer is possible to playback on this DVD player.

- 1 Load a SACD.
→ The disc menu appears on the TV screen.
- 2 Playback will start automatically.
→ If the SACD consists of multi-channel and stereo tracks, multi-channel tracks will have the priority for playback.
→ To playback stereo tracks, use ▲ ▼ keys to make your selection from the disc menu, then press ► (or ►II).

Helpful Hint
– Programming SACD tracks is not possible.

Special features for picture disc playback

IMPORTANT!

You have to turn on your TV and set to the correct Video In channel. (See page 17 "Setting the TV").

- Load a Picture disc (Kodak Picture CD, JPEG).
→ For Kodak disc, the slide show will begin.
→ For JPEG disc, the picture menu appears on the TV screen. Press ► (or ►II) to start the slide-show playback.

Preview Function

This function shows the content of the current folder or the whole disc.

- 1 During playback, press ■.
→ 12 thumbnail pictures will appear on the TV screen.

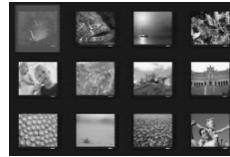

- 2 Press ◀◀ / ▶▶ to display the other pictures on the previous/next page.
- 3 Use ◀ ▶ ▲ ▼ keys to highlight one of the picture and press **OK** to start playback.
- 4 Press **DISC MENU** to return to Picture CD menu.

Zoom picture

- 1 During playback, press **ZOOM** repeatedly to select different zoom factor.
- 2 Use ◀ ▶ ▲ ▼ keys to move through the zoomed image.

Playback with multi-angles

- During playback, use ◀ ▶ ▲ ▼ keys to rotate/flip the picture on the TV screen.
 - ▲ : flip the picture vertically
 - ▼ : flip the picture horizontally
 - ◀ : rotate the picture anti-clockwise
 - ▶ : rotate the picture clockwise

Scan Effect

- Press **ANGLE** repeatedly to choose a different scan effect.
→ Various scan effects appear in the top left corner of the TV screen.

TIPS: The operating features described here might not be possible for certain discs. Always refer to the instructions supplied with the discs.

DVD Setup Menu Options

This DVD system setup is carried out via the TV, enabling you to customise the DVD system to suit your particular requirements.

General Setup menu

- 1 In disc mode, press **SYSTEM MENU**.
- 2 Press ◀▶ to select 'General Setup' icon.
- 3 Press **OK** to confirm.

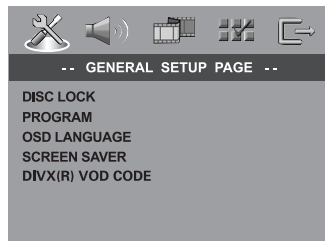

Locking/Unlocking the disc for viewing

Not all discs are rated or coded by the disc maker. You can prevent a specific disc from playing by locking the disc. Up to 40 discs can be locked.

- 1 In 'GENERAL SETUP PAGE', press ▲▼ to highlight {DISC LOCK}, then press ▶.

LOCK

Select this to block the playback of the current disc. Subsequent access to a locked disc requires six-digit password. The default password is '136900' (see page 35 "Changing the password").

UNLOCK

Select this to unlock the disc and allow future playback.

- 2 Press ▲▼ to select a setting and press **OK** to confirm.

Programming disc tracks (not for Picture CD/MP3/SACD)

You can play the contents of the disc in the order you want by programming the tracks to be played. Up to 20 tracks can be stored.

- 1 Press **PROGRAM** on the remote.
OR
In 'GENERAL SETUP PAGE', press ▲▼ to highlight {PROGRAM}, then press ▶ to select {INPUT MENU}.
- 2 Press **OK** to confirm.

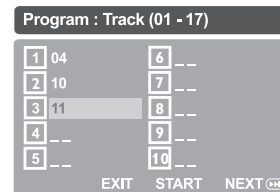

To programme your favourite tracks/ chapter

- 3 Use the **numeric keypad (0-9)** to enter a valid track/chapter number.
- 4 Use ◀▶▲▼ keys to move the cursor to the next position.
→ If the track number is more than ten, press ▶▶ to open the next page and proceed with programming or,
→ Use ◀▶▲▼ keys to highlight {NEXT} on the programme menu, then press **OK**.
- 5 Repeat steps 3~4 to input another track/chapter number.

If you want to remove a track

- 6 Use ◀▶▲▼ keys to move the cursor to the track you want to remove.
- 7 Press **OK** to remove this track from the programme menu.

TIPS: To return to the previous menu, press ◀.
To remove the menu, press **SYSTEM MENU**.

DVD Setup Menu Options

To start programme playback

- Use ◀▶ ▲▼ keys to highlight {START} on the programme menu, then press **OK**.
→ Playback will start with the selected tracks under the programmed sequence.

To exit programme playback

- Use ◀▶ ▲▼ keys to highlight {EXIT} on the programme menu, then press **OK**.

OSD Language

This menu contains various language options for display language on the screen. For details, see page 19.

Screen Saver - turning on/off

The screen saver will help to prevent your TV display device from becoming damaged.

- In 'GENERAL SETUP PAGE', press ▲▼ to highlight {SCREEN SAVER}, then press ▶.

ON

Select this if you wish to turn off the TV screen when play is stopped or paused for more than 15 minutes.

OFF

Select this to disable the screen saver function.

- Press ▲▼ to select a setting and press **OK** to confirm.

DivX® VOD registration code

Philips provide you the DivX® VOD (Video On Demand) registration code that allows you to rent and purchase videos using the DivX® VOD service. For more information, visit us at www.divx.com/vod.

- In 'GENERAL SETUP PAGE', press ▲▼ to highlight {DIVX(R) VOD CODE}, then press ▶.
→ The registration code will appear.
- Press **OK** to exit.
- Use the registration code to purchase or rent the videos from DivX® VOD service at www.divx.com/vod. Follow the instructions and download the video onto a CD-R/RW for playback on this DVD system.

Helpful Hints:

- All the downloaded videos from DivX® VOD can only be played back on this DVD system.
- Time search feature is not available during DivX® movie playback.

English

TIPS: To return to the previous menu, press ◀.
To remove the menu, press **SYSTEM MENU**.

DVD Setup Menu Options

Audio Setup Menu

- 1 In disc mode, press **SYSTEM MENU**.
- 2 Press ◀▶ to select 'Audio Setup' icon.
- 3 Press **OK** to confirm.

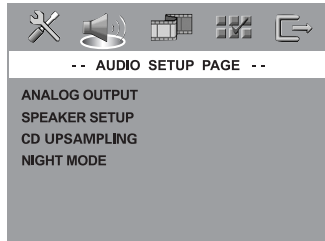

Setting the analogue output

Set Analogue Output to match your DVD home theatre system's playback capability. This function can also be accessed via the **SURR.** button on the remote.

- 1 In 'AUDIO SETUP PAGE', press ▲▼ to highlight {ANALOG OUTPUT}, then press ▶.

STEREO

Select this to change channel output to stereo that delivers sound from only the two front speakers and subwoofer.

MULTI-CHANNEL

Select this to enable Multi-channel output.

- 2 Press ▲▼ to select a setting and press **OK** to confirm.

Helpful Hint:

– This feature is not available for SACD playback.

Speaker Setup

This menu contains setup options for your audio output which makes the speaker setup system reproduce high quality surround sound. For details, see page 20.

CD Upsampling

This feature allows you to convert your music CD to a higher sampling rate using sophisticated digital signal processing for better sound quality. This function can also be accessed via the **CD UP SAMP.** button on the remote.

If you have activated the upsampling, the system will automatically switch to stereo mode.

- 1 In 'AUDIO SETUP PAGE', press ▲▼ to highlight {CD UPSAMPLING}, then press ▶.

OFF

Select this to disable CD-upsampling.

88.2 kHz (X2)

Select this to convert the sampling rate of the CDs twice higher than the original.

- 2 Press ▲▼ to select a setting and press **OK** to confirm.

Helpful Hint:

– If you select "Multi-Channel" mode, it will disable the CD upsampling feature.

TIPS: To return to the previous menu, press ◀.
To remove the menu, press **SYSTEM MENU**.

DVD Setup Menu Options

Night Mode - turning on/off

When night mode is activated, the high volume outputs are softened and low volume outputs are brought upward to an audible level (for DVD only). It is useful for watching your favourite action movie without disturbing others at night. This function can also be accessed via the **NIGHT** button on the remote.

- 1 In 'AUDIO SETUP PAGE', press ▲▼ to highlight {NIGHT MODE}, then press ►.

ON

Select this to level out the volume.

OFF

Select this when you want to enjoy the surround sound with its full dynamic range.

- 1 Press ▲▼ to select a setting and press **OK** to confirm.

Video Setup Menu

- 1 In disc mode, press **SYSTEM MENU**.
- 2 Press ◀▶ to select 'Video Setup' icon.
- 3 Press **OK** to confirm.

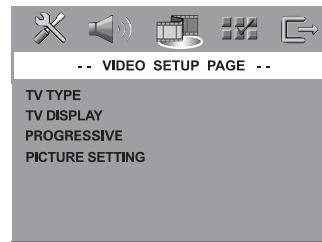

TV Type

This menu contains the options for selecting the colour system that matches the connected TV. For details, see page 18.

TV Display

This menu contains the options for setting the aspect ratio of the DVD system according to the connected TV. For details, see page 18.

TIPS: To return to the previous menu, press ◀.
To remove the menu, press **SYSTEM MENU**.

DVD Setup Menu Options

Progressive function - turning on/off

The progressive scan display present 60 complete frames per seconds, rather than 30 frames per second of interlaced scanning (ordinary normal TV system). With nearly double the number of lines, progressive scan offers higher picture resolution and eliminates bothersome motion artifacts those jagged edge on moving objects.

IMPORTANT!

Before enabling the progressive scan function, you must ensure :

- 1) Turn on your TV progressive scan function (refer to your TV owner's manual).
- 2) You have connected the DVD system to your TV using Y Pb Pr (see page 10).

- 1 In 'VIDEO SETUP PAGE', press ▲▼ to highlight {PROGRESSIVE}, then press ►.

OFF

Select this to disable progressive scan function.

ON

Select this to enable progressive scan function.

- 2 Press ▲▼ to select a setting and press **OK** to confirm.
→ Follow the instructions shown on the TV to confirm the selection (if any).
→ If a blank/distorted TV screen appears, wait for 15 seconds for auto recovery.

Picture Setting

This DVD system provides three predefined sets of picture colour settings and one personal setting which you can define yourself.

- 1 In 'VIDEO SETUP PAGE', press ▲▼ to highlight {PICTURE SETTING}, then press ►.

STANDARD

Select this for standard picture setting.

BRIGHT

Select this will make the TV picture brighter.

SOFT

Select this will make the TV picture softer.

PERSONAL

Select this to personalise your picture colour by adjusting the brightness, contrast, tint and colour (saturation).

- 2 Press ▲▼ to select a setting and press **OK** to confirm.
- 3 If you select {PERSONAL}, then proceed to steps 4 ~ 7.
→ The 'PERSONAL PICTURE SETUP' menu appears.

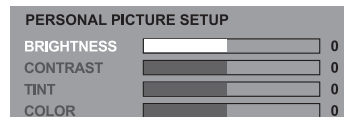

- 4 Press ▲▼ to highlight one of the following options.

BRIGHTNESS

Increase the value to brighten the picture or vice versa. Choose zero (0) for average setting.

TIPS: To return to the previous menu, press ◀.
To remove the menu, press **SYSTEM MENU**.

DVD Setup Menu Options

CONTRAST

Increase the value to sharpen the picture or vice versa. Choose zero (0) to balance the contrast.

TINT

Increase or decrease the value to change the colour phase of the picture. Choose zero (0) for average setting.

COLOUR

Increase the value to enhance the colour in your picture or vice versa. Choose zero (0) to balance the colour.

- 5 Press ◀▶ to adjust the setting that best suit your personal preference.
- 6 Repeat steps 4~5 for adjusting other colour features.
- 7 Press **OK** to confirm.

Preference Setup Menu

- 1 Press ■ twice to stop playback (if any), then press **SYSTEM MENU**.
- 2 Press ◀▶ to select the 'Preference Setup' icon.
- 3 Press **OK** to confirm.

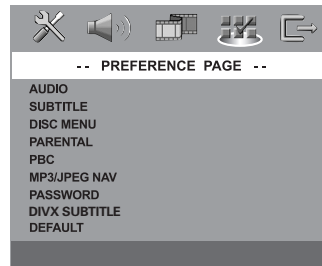

Audio, Subtitle, Disc Menu

These menus contain various language options for audio, subtitle and disc menu which may be recorded on the DVD. For details, see page 19.

Restricting playback by Parental Control

Some DVDs may have a parental level assigned to the complete disc or to certain scenes on the disc. This feature lets you set a playback limitation level. The rating levels are from 1 to 8 and are country dependent. You can prohibit the playing of certain discs that are not suitable for your children, or have certain discs played with alternative scenes.

TIPS: To return to the previous menu, press ◀.
To remove the menu, press **SYSTEM MENU**.

DVD Setup Menu Options

- In 'PREFERENCE PAGE', press ▲▼ to highlight {PARENTAL}, then press ►.

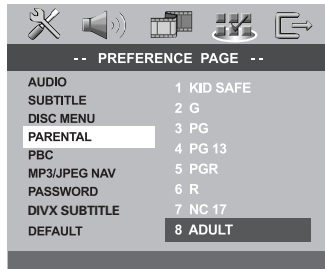

- Press ▲▼ to highlight a rating level for the disc inserted and press **OK**.
- Use the **numeric keypad (0-9)** to enter the six-digit password (see page 35 "Changing the password").
→ DVDs that are rated above the level you selected will not play unless you enter your six-digit password.

Rating explanations

1 KID SAFE – 2 G

- General Audience; recommended as acceptable for viewers of all ages.

3 PG

- Parental Guidance suggested.

4 PG13

- Material is unsuitable for children under age 13.

5 PGR – 6 R

- Parental Guidance - Restricted; recommended that parents restrict children under 17 from viewing or allow to view only when supervised by a parent or adult guardian.

7 NC-17

- No children under age 17; not recommended viewing for children under age 17.

8 ADULT

- Mature material; should be viewed only by adults due to graphic sexual material, violence or language.

Helpful Hints:

- VCD, SVCD, CD have no level indication, so parental control has no effect on these type of discs. This also applies to most illegal DVDs.
- Some DVDs are not encoded with a rating though the movie rating may be printed on the Disc cover. The rating level feature does not prohibit play of such Discs.

PBC

You can set the PBC to ON or OFF. This feature is available only on Video CD 2.0 with playback control (PBC) feature. For details, see page 25.

MP3/JPEG Menu - turning on/off

MP3/JPEG Navigator can be set only if the disc is recorded with menu. It allows you to select different display menus for easy navigation.

- In 'PREFERENCE PAGE', press ▲▼ to highlight {MP3/JPEG NAV}, then press ►.

WITHOUT MENU

Select this to display all the files contained in the MP3/Picture CD.

WITH MENU

Select this to display only the folder menu of the MP3/Picture CD.

- Press ▲▼ to select a setting and press **OK** to confirm.

TIPS: To return to the previous menu, press ◀.
To remove the menu, press **SYSTEM MENU**.

DVD Setup Menu Options

Changing the Password

The same password is used for both Parental Control and Disc Lock. Enter your six-digit password to play a prohibited disc or if prompted for a password. The default password is **136900**.

- 1 In 'PREFERENCE PAGE', press ▲▼ to highlight {PASSWORD}, then press ► to select {CHANGE}.

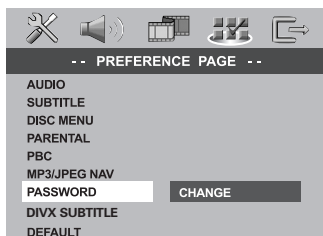

- 2 Press **OK** to enter the 'Password Change Page'.

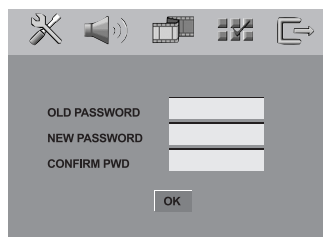

- 3 Use the **numeric keypad (0-9)** to enter your old six-digit password.
 - When doing this for the first time, key in '136900'.
 - If you forget your old six-digit password, key in '136900'.
- 4 Enter the new six-digit password.
- 5 Enter the new six-digit password a second time to confirm.
 - The new six-digit password will now take effect.
- 6 Press **OK** to confirm.

Setting the DivX Subtitle

- **When selecting an embedded subtitle during DivX disc playback**, press **SUBTITLE** repeatedly to select available subtitle.

OR

- 1 **When selecting an external DivX text subtitle during playback**, If available on the recorded disc, you can select the external DivX subtitle in text format.
- 2 In 'PREFERENCE PAGE', press ▲▼ to highlight {DIVX SUBTITLE}, then press ►.

STANDARD

A standard list of English subtitle fonts provided by this DVD Player.

CYRILLIC

Select this to display a cyrillic subtitle fonts.

- 3 Press ▲▼ to select a setting, then press **OK** to confirm your selection.

Helpful Hints:

- Subtitle files with the following filename extensions (.srt, .smi, .sub, .ssa, .ass) are supported but do not appear on the file navigation menu.
- The subtitle filename has to be the same as the filename of the movie.

Restoring to original settings

Setting the DEFAULT function will reset all options and your personal settings to the factory defaults, except your password for Parental Control and Disc Lock.

- 1 In 'PREFERENCE PAGE', press ▲▼ to highlight {DEFAULT}, then press ► to select {RESET}.
- 2 Press **OK** to confirm.
 - All settings will now reset to factory defaults.

TIPS: To return to the previous menu, press ◀.
To remove the menu, press **SYSTEM MENU**.

Tuner Operations

IMPORTANT!
Make sure the FM and MW antennas are connected.

Tuning to radio stations

- 1 Press **SOURCE** control to select "TUNER FM" or "TUNER MW".
- 2 Press **▲▼** briefly on the remote.
→ "SEARCH" appears.
→ The next radio station will tune automatically.
- 3 Repeat step 2 if necessary until you find the desired radio station.
- 4 To tune a weak station, press **◀◀ / ▶▶** briefly and repeatedly until an optimal reception is found.
- If the FM station reception is weak, you can switch the FM mode from stereo to mono. Press **SURR** button will toggle through:
 - DOLBY PL II FM ST (stereo)
 - DOLBY PL II FM MONO
 - STEREO FM MONO
 - STEREO FM ST

Presetting radio stations

You can store up to 20 FM and 10 MW preset radio stations in the memory.

Helpful Hints:

- The system will exit presetting mode if no button is pressed within 20 seconds.
- If no valid frequency is detected during Plug and Play, "CHECK ANTENNA" appears.

Using the Plug and Play

Plug and Play allows you to store all available radio stations automatically.

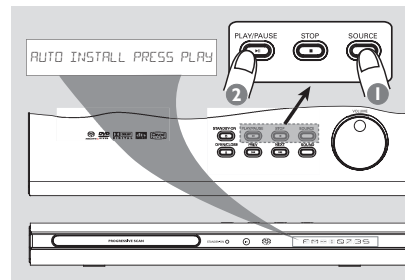

- 1 For first time setup, press **SOURCE** on front panel to select TUNER mode.
→ "AUTO INSTALL PRESS PLAY" appears.
- 2 Press **▶||** on the top panel to start installation.
→ "INSTALL TUNER" appears.
→ Once complete, the last tuned radio station will play.
→ FM followed by MW bands will be stored.

Tuner Operations

Automatic presetting

You can start the automatic presetting from a selected preset number.

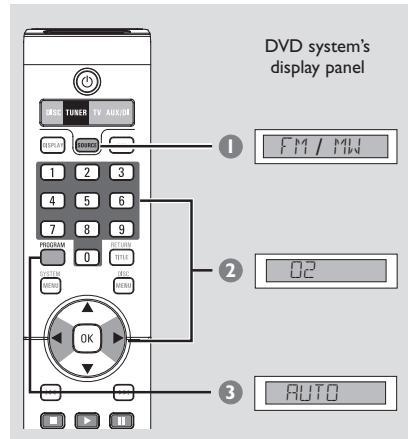

- 1 Press **SOURCE** control to select "TUNER FM" or "TUNER MW".
- 2 Press ◀ ▶ or use the **numeric keypad (0-9)** to select a preset number to begin.
- 3 Press and hold **PROGRAM** until "AUTO" appears.
 - If a radio station is stored in one of the earlier presets, the same radio station will not store under another preset number.
 - If no preset number is selected, automatic preset will begin from preset (1) and all your former presets will be overridden.

Manual presetting

You can choose to store only your favourite radio stations.

- 1 Tune to your desired radio station (see "Tuning to radio stations").
- 2 Press **PROGRAM**.
- 3 Press ◀ ▶ to select a preset number.
- 4 Press **PROGRAM** again to store.

Selecting a preset radio station

- Press ◀ ▶ or use the **numeric keypad (0-9)** to select a preset number.
 - The waveband, preset number followed by radio frequency will appear.

Deleting a preset radio station

- Press and hold ■ until "FMXX DELETED" or "MWXX DELETED" appears.
 - The current preset radio station will be deleted.

Changing tuning grid *(not available for all versions)*

In some countries, the frequency step between adjacent channels in the MW band is 9 kHz (10 kHz in some areas). The preset frequency step in the factory is 9 kHz.

IMPORTANT! Changing the tuning grid will erase all previously stored preset radio stations.

- 1 Press **SOURCE** repeatedly to select "TUNER FM" or "TUNER MW".
- 2 Disconnect the power cord from the power supply.
- 3 While holding down **SOURCE** and ◀◀◀ buttons on the front panel, connect the power cord to the power supply again.
 - The display will show "GRID 9" or "GRID 10".

Helpful Hints:

- GRID 9 and GRID 10 indicate that the tuning grid is in step of 9 kHz and 10 kHz respectively.
- The FM tuning grid also will be changed from 50 kHz to 100 kHz or vice versa.

Sound Controls

IMPORTANT!

For proper surround sound, make sure the speakers and AV subwoofer are connected (see page 8).

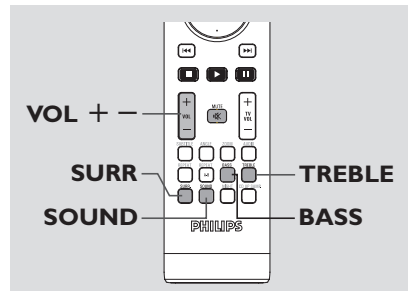

Selecting surround sound

- Press **SURR** on the remote to select : MULTI-CHANNEL or STEREO.
 - The availability of the various surround sound modes depends on the number of speakers used and the sound available on the disc.
 - The centre and surround speakers operate only in Multi-channel surround mode.
 - The available output modes for Multi-channel include: Dolby Digital, DTS (Digital Theatre Systems) Surround and Dolby Pro Logic II.
 - Stereo broadcasts or recordings will produce some surround channel effects when played in a surround mode. However, mono (single channel sound) sources will not produce any sound from the surround speakers.

Helpful Hints:

- *SURR* button is not functional for SACD playback. You have to access to the disc menu in order to select between multi-channel and stereo tracks, see page 27.
- You are not able to select the surround sound mode if the system setup menu is turned on.

Selecting digital sound effects

Select a preset digital sound effects that matches your disc's content or that optimises the sound of the musical style you are playing.

- Press **SOUND** to select the available sound effect.

When playing movie discs or in TV mode, you can select : CONCERT, DRAMA, ACTION or SCI-FI.

When playing music discs or while in TUNER or AUX/DI mode, you can select : ROCK, DIGITAL, CLASSIC or JAZZ.

Helpful Hint:

- For flat sound output, select *CONCERT* or *CLASSIC*.

Adjusting the Bass/Treble level

The BASS (low tone) and TREBLE (high tone) features enable you to define the sound-processor settings.

- 1 Press **BASS** or **TREBLE** on the remote.
- 2 Within five seconds, use the **VOL + –** to adjust the Bass or Treble level (MIN, -2, -1, 0, +1, +2 or MAX).
 - If the volume control is not used within five seconds, it will resume its normal volume control function.

Volume Control and Other Functions

Switching on/off

Switching to active mode

- Press the **SOURCE** control to select :
DISC → TUNER FM → TUNER MW
→ TV → AUX → DIGI IN → DISC

Switching to Eco Power standby mode

- Press **STANDBY ON** (⏻).
→ The display screen will go blank.

Volume control

- Adjust **VOLUME** control (or press **VOL + / -** on the remote) to increase or decrease the volume level.
→ "VOL MIN" is the minimum volume level and "VOL MAX" is the maximum volume level.

To turn off the volume temporarily

- Press **MUTE** on the remote.
→ Playback will continue without sound and "MUTE" appears.
→ To restore the volume, press **MUTE** again or increase the volume level.

Dimming system's display screen

- In any active mode, press **DIM** on the remote to select the desired brightness :

DIM 1 : 70% brightness
DIM 2 : 50% brightness
DIM 3 : 25% brightness
DIM OFF : normal brightness

Using the remote to operate your 'Philips' television

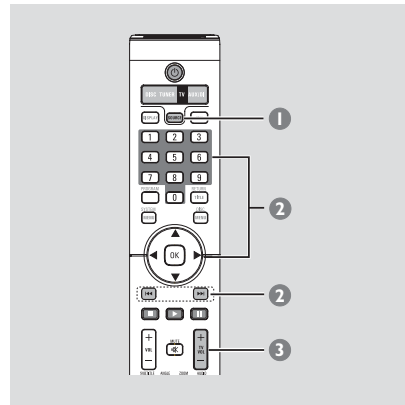

- 1 Press **SOURCE** control until "TV" appears on the display panel.
- 2 Press **◀◀ / ▶▶** or use the **numeric keypad (0-9)** to select the TV's channel.
- 3 Press **TV VOL + / -** to adjust the TV's volume level.

Helpful Hint:

– When listening to TV or AUX/DI programmes, press the respective TV or AUX/DI button on the remote in order for the sound to be heard.

Other Functions

Changing wire-less rear speakers transmission channel

The wire-less rear speaker system will automatically turn on once you power up. If there is a sound distortion, select another transmission channel.

- 1 Press and hold **SOUND** on the remote until "CH X" appears on the display panel. → "X" denotes the frequency channel 1~4.
- 2 Repeat the above if necessary until you find a suitable transmission channel.

Helpful Hint:

– The distortion could be the result of interference caused by other equipment using same frequency channel in your house or neighborhood.

Recording to an external device

- 1 Connect the external recording device to **LINE OUT (R/L)**. (See page 12 "Connections-optional").
- 2 Select the source to record from your DVD system (DISC, TUNER, TV or AUX/DI) and start playback (if necessary).
- 3 For ultimate recording, press **SOUND** to select 'CLASSIC' or 'CONCERT' and press **SURR** to select 'STEREO'.
- 4 Start recording on the external recording device.

Helpful Hint:

– Refer to the owner's manual of the connected equipment for details.

Setting the Sleep timer

The sleep timer enables the system to switch to Eco Power standby mode automatically at a preset time.

- 1 Press and hold **DIM** on the remote until "SLEEP XX" appear on the display panel (XX = 15, 30, 45, 60 or OFF).
- 2 To select the next sleep timer value, continue pressing **DIM** button while in sleep timer mode until it reaches the desired preset turn-off time.
 - **SLEEP** will show on the display panel, except if "OFF" is selected.
 - Before the system switches to Eco Power standby mode, a countdown of 10 seconds is displayed.
 - "SLEEP 10" → "SLEEP 9".... → "SLEEP 1" → "SLEEP"

To cancel the sleep timer

- Press and hold **DIM** until "OFF" appears or press the **STANDBY ON** (⏻) button.

Specifications

English

AMPLIFIER SECTION

Output power	600 W RMS
- Front	100 W RMS / channel
- Rear	75 W RMS / channel
- Centre	100 W RMS
- Subwoofer	150 W RMS
Frequency Response	20 Hz – 50 kHz / –3 dB
Signal-to-Noise Ratio	> 65 dB (CCIR)
Input Sensitivity	
- AUX In	1000 mV
- DIGITAL In	500 mV

TUNER SECTION

Tuning Range	FM 87.5 – 108 MHz (50 kHz) MW 531 – 1602 kHz (9 kHz) MW 530 – 1700 kHz (10 kHz)
26 dB Quieting Sensitivity	FM 20 dB MW 4 µV/m
Image Rejection Ratio	FM 25 dB MW 28 dB
IF Rejection Ratio	FM 60 dB MW 45 dB
Signal-to-Noise Ratio	FM 60 dB MW 40 dB
AM Suppression Ratio	FM 30 dB
Harmonic Distortion	FM Mono 3% FM Stereo 3% MW 5%
Frequency Response	FM 180 Hz – 10 kHz / ±6 dB
Stereo Separation	FM 26 dB (1 kHz)
Stereo Threshold	FM 23.5 dB

DISC SECTION

Laser Type	Semiconductor
Disc Diametre	12cm / 8cm
Video Decoding	MPEG-1 / MPEG-2 / MPEG-4 / DivX 3.11, 4.x & 5.x
Video DAC	12 Bits
Signal System	PAL / NTSC
Video Format	4:3 / 16:9
Video S/N	56 dB (minimum)
Composite Video Output	1.0Vp-p, 75 Ω
S-Video Output	Y - 1.0Vp-p, 75 Ω C - 0.286Vp-p, 75 Ω
Audio DAC	24 Bits / 96 kHz
Frequency Response	4 Hz – 20 kHz (44.1 kHz) 4 Hz – 22 kHz (48 kHz) 4 Hz – 44 kHz (96 kHz)
PCM	IEC 60958
Dolby Digital	IEC 60958, IEC 61937
DTS	IEC 60958, IEC 61937
SACD D/A converter	PCM
SACD cut-off frequency	50 kHz

MAIN UNIT

Power Supply Rating	34V DC
Power Consumption	20 W
Dimensions (w x h x d)	360 mm x 40 mm x 305 mm
Weight	2.5 kg

FRONT SPEAKERS

System	2-way, closed box system
Impedance	6 Ω
Speaker drivers	2 x 3" woofer + 1 x "LS" ribbon tweeter
Frequency response	120 Hz – 20 kHz
Dimensions (w x h x d)	230mm x 1120mm x 200mm
Weight	5.2 kg/each

WIRE-LESS REAR SPEAKERS

Power Supply Rating	120 – 240 V
Transmission Frequency	2400 - 2483.5 MHz
Transmission Channel	4
Frequency response	8 Ω, 120 Hz – 20 kHz
Dimensions (w x h x d)	230mm x 1120mm x 200mm
Weight	5.5 kg/each

CENTRE SPEAKER

System	2-way, closed box system
Impedance	6 Ω
Speaker drivers	4 x 2" woofers + 1 x 3/4" tweeter
Frequency response	120 Hz – 20 kHz
Dimensions (w x h x d)	435 mm x 76 mm x 70 mm
Weight	1.4 kg

AV SUBWOOFER

Power Supply Rating	110 – 127 / 220 – 240V; 50/60 Hz Switchable
Power consumption	140 W
System	Bass Reflex System
Impedance	4 Ω
Speaker driver	6 1/2" woofer
Frequency response	30 Hz – 120 Hz
Dimensions (w x h x d)	300 mm x 400 mm x 300 mm
Weight	12 kg

Specifications subject to change without prior notice

Troubleshooting

WARNING

Under no circumstances should you try to repair the system yourself, as this will invalidate the warranty. Do not open the system as there is a risk of electric shock.

If a fault occurs, first check the points listed below before taking the system for repair. If you are unable to remedy a problem by following these hints, consult your dealer or Philips for help.

Problem	Solution
No power.	<ul style="list-style-type: none"> – Check if the AC power cord is properly connected. – Press the STANDBY ON on the front of the DVD system to turn on the power.
No picture.	<ul style="list-style-type: none"> – Refer to your TV's manual for correct Video In channel selection. Change the TV channel until you see the DVD screen. – Press SOURCE to select Disc mode.
Completely distorted picture or black/white picture.	<ul style="list-style-type: none"> – If this happens when you are changing the setting of the 'TV TYPE', wait for 15 seconds for auto recovery. – If this happens when you are turning on the progressive scan feature, wait for 15 seconds for auto recovery. – Check the video connection. – Sometimes a small amount of picture distortion may appear. This is not a malfunction. – Clean the disc.
The aspect ratio of the screen cannot be changed even though you have set the TV display.	<ul style="list-style-type: none"> – The aspect ratio is fixed on the DVD disc. – Depending on the TV, it may not be possible to change the aspect ratio.
No sound or distorted sound.	<ul style="list-style-type: none"> – Adjust the volume. – Check the speaker connections and settings. – Make sure that the audio cables are connected and press the SOURCE button to select the correct input source (TV or AUX/DI, for example) to choose the equipment that you want to hear through the DVD system. – If this happens on the wire-less rear speakers, hold down SOUND button to select another transmission channel.
Cannot activate some features such as Angles, Subtitles, or multi-language Audio.	<ul style="list-style-type: none"> – The features may not be available on the DVD. – Changing the language for the sound or subtitle is prohibited on the DVD.

NOTE: When sending the product for servicing, both the DVD main system and the AV subwoofer are required.

Troubleshooting

Problem	Solution
The DVD player does not start playback.	<ul style="list-style-type: none"> – Insert a readable disc with the playback side facing down. The DVD+R/CD-R must be finalised. – Check the disc type, colour system (PAL or NTSC) and region code. – Check for any scratches or smudges on the disc. – Press SYSTEM MENU to turn off the setup menu screen. – You may need to enter the password in order to change the parental control rating level or to unlock the disc for playback. – Moisture has condensed inside the system. Remove the disc and leave the system turned on for about an hour.
There is no sound from the centre and surround speakers.	<ul style="list-style-type: none"> – Make sure the centre and surround speakers are connected correctly. – Press SURR button to select a correct surround sound setting. – Make sure the source you are playing is recorded or broadcast in surround sound (DTS, Dolby Digital, etc.).
Radio reception is poor.	<ul style="list-style-type: none"> – If the signal is too weak, adjust the antenna or connect an external antenna for better reception. – Increase the distance between the system and your TV or VCR. – Tune in to the correct frequency. – Place the antenna farther away from any equipment that may be causing the noise.
The remote control does not function properly.	<ul style="list-style-type: none"> – Select the source (DISC or TUNER, for example) before pressing the function button (▶, ◀◀, ▶▶). – Reduce the distance between the remote control and the system. – Replace the batteries with new ones. – Point the remote control directly toward the IR sensor. – Check that the batteries are loaded correctly.
Unable to play DivX movies.	<ul style="list-style-type: none"> – Check that the DivX file is encoded in 'Home Theatre' mode with DivX 5.x encoder.
The DVD system does not work.	<ul style="list-style-type: none"> – Disconnect the power cord from the power outlet for a few minutes. Reconnect the power cord and try to operate again as usual.

NOTE: When sending the product for servicing, both the DVD main system and the AV subwoofer are required.

Glossary

Analogue: Sound that has not been turned into numbers. Analogue sound varies, while digital sound has specific numerical values. These jacks send audio through two channels, the left and right.

Aspect ratio: The ratio of vertical and horizontal sizes of a displayed image. The horizontal vs. vertical ratio of conventional TVs. is 4:3, and that of wide-screens is 16:9.

AUDIO OUT Jacks: Red and white jacks on the back of the DVD System that send audio to another system (TV, Stereo, etc.).

Bit Rate: The amount of data used to hold a given length of music; measured in kilobits per second, or kbps. Or, the speed at which you record. Generally, the higher the bit rate, or the higher the recording speed, the better the sound quality. However, higher bit rates use more space on a Disc.

Chapter: Sections of a picture or a music piece on a DVD that are smaller than titles. A title is composed of several chapters. Each chapter is assigned a chapter number enabling you to locate the chapter you want.

Component Video Out Jacks: Jacks on the back of the DVD System that send high-quality video to a TV that has Component Video In jacks (R/G/B, Y/Pb/Pr, etc.).

Disc menu: A screen display prepared for allowing selection of images, sounds, subtitles, multi-angles, etc recorded on a DVD.

DivX 3.11/4.x/5.x: The DivX code is a patent-pending, MPEG-4 based video compression technology, developed by DivXNetworks, Inc., that can shrink digital video to sizes small enough to be transported over the internet, while maintaining high visual quality.

Dolby Digital: A surround sound system developed by Dolby Laboratories containing up to six channels of digital audio (front left and right, surround left and right, centre and subwoofer).

Dolby Surround Pro Logic II: It is an improved matrix decoding technology that provides better spatiality and directionality on Dolby Surround programme material; provides a convincing three-dimensional soundfield on conventional stereo music recordings; and is ideally suited to bring the surround experience to automotive sound. While conventional surround programming is fully compatible with Dolby Surround Pro Logic II decoders, soundtracks will be able to be encoded specifically to take full advantage of Pro Logic II playback, including separate left and right surround channels. (Such material also compatible with conventional Pro Logic decoders).

DTS: Digital Theatre Systems. This is a surround sound system, but it is different from Dolby Digital. The formats were developed by different companies.

JPEG: A very common digital still picture format. A still-picture data compression system proposed by the Joint Photographic Expert Group, which features small decrease in image quality in spite of its high compression ratio.

MP3: A file format with a sound data compression system. "MP3" is the abbreviation of Motion Picture Experts Group 1 (or MPEG-1) Audio Layer 3. By using the MP3 format. One CD-R or CD-RW can contain about 10 times more data than a regular CD.

Multichannel: DVDs are formatted to have each sound track constitute one sound field. Multichannel refers to a structure of sound tracks having three or more channels.

Parental control: Limits Disc play according to the age of the users or the limitation level in each country. The limitation varies from disc to disc; when it is activated, playback will be prohibited if the software's level is higher than the user-set level.

Glossary

English

Playback control (PBC): Refers to the signal recorded on video CDs or SVCDs for controlling playback. By using menu screens recorded on a Video CD or SVCD that supports PBC, you can enjoy interactive playback and searching.

Plug and Play: First time power up to the Tuner mode, the system will prompt the user to proceed with the automatic installation of radio stations by simply pressing the PLAY button on the main unit.

Progressive Scan: It displays all the horizontal lines of a picture at one time, as a signal frame. This system can convert the interlaced video from DVD into progressive format for connection to a progressive display. It dramatically increases the vertical resolution.

Region code: A system allowing discs to be played only in the region designated. This unit will only play discs that have compatible region codes. You can find the region code of your unit by looking on the product label. Some discs are compatible with more than one region (or ALL regions).

S-Video: Produces a clear picture by sending separate signals for the luminance and the colour. You can use S-Video only if your TV has an S-Video In jack.

Super Audio CD (SACD): This audio format is based upon the current CD standards but includes a greater amount of information that provides higher quality sound. There are three types of discs: single layer, double layer and hybrid discs. The hybrid disc contains both standard audio CD and Super Audio CD information.

Surround: A system for creating realistic three-dimensional sound fields full of realism by arranging multiple speakers around the listener.

Title: The longest section of a movie or music feature on DVD. Each title is assigned a title number, enabling you to locate the title you want.

VIDEO OUT jack: Yellow jack on the back of the DVD system that sends the DVD picture video to a TV.

English

中文(简体)

中文(繁體)

Bahasa Melayu

Meet Philips at the Internet
<http://www.philips.com>
<http://www.p4c.philips.com>

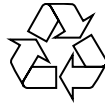

LX8500W



3139 115 23232



SgpJP-0433/69-4

QUICK USE GUIDE 12nc: 3139 115 23181

LX8500W

**First connect ...
... then play** (see next page)

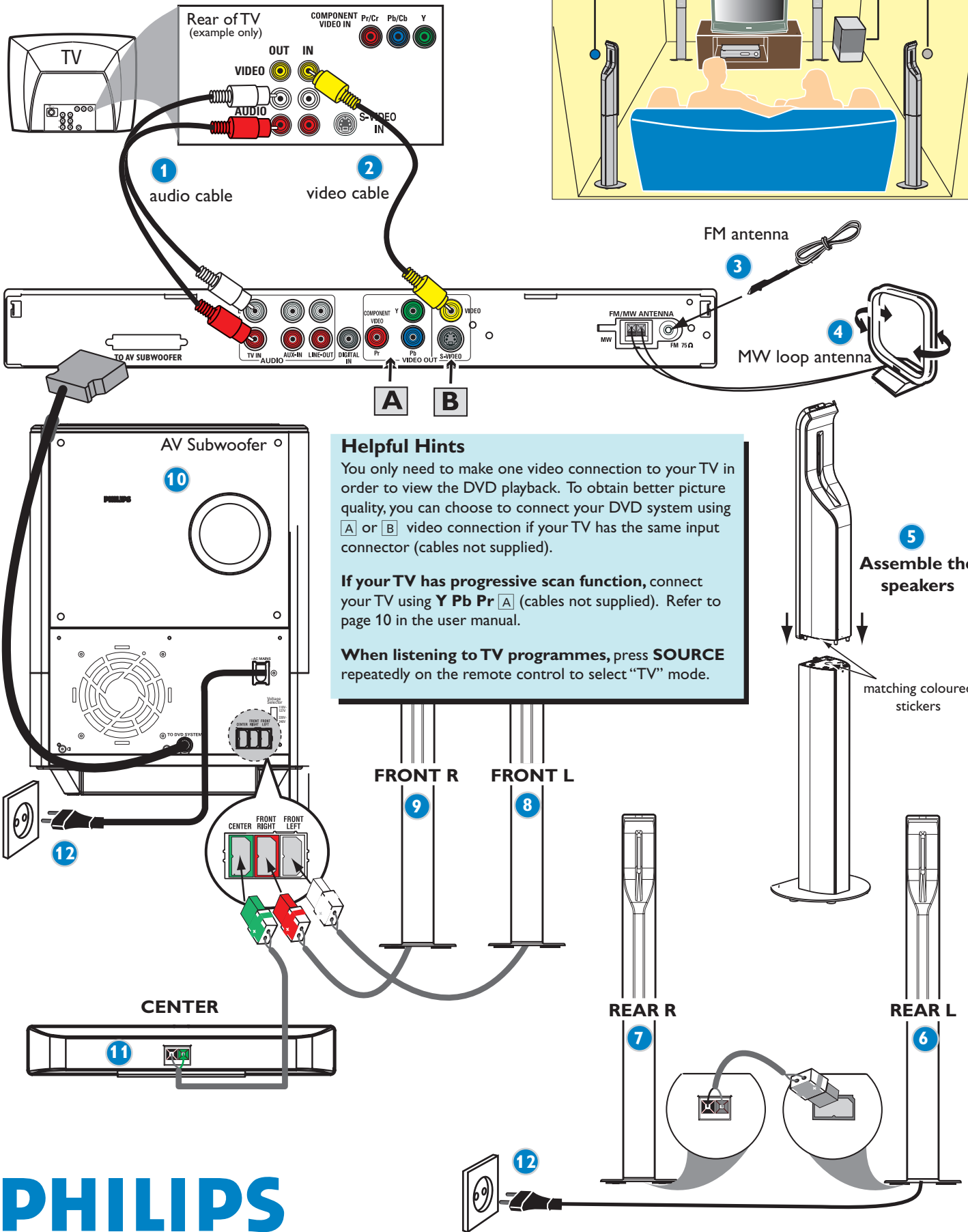

PHILIPS

Playing a disc

Make sure your DVD system and TV are connected and turned on!

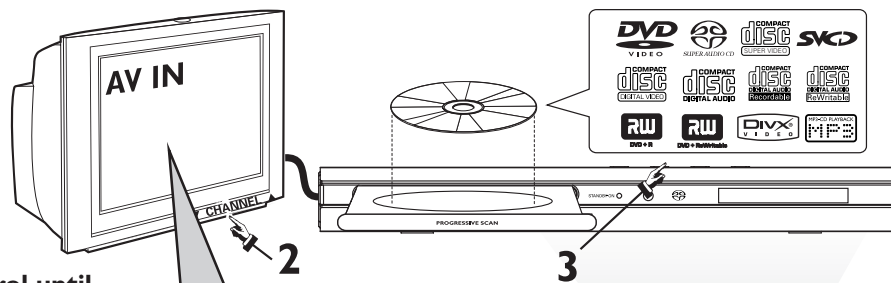

1 Press SOURCE on the remote control until "DISC" appears on the display panel.

The DISC LED on the remote will light up for a few seconds.

2 Turn on the TV and select the correct Video In mode.

You should see the blue DVD background screen on the TV (if no disc in the DVD system).

3 Press OPEN/CLOSE ▲ at the top of the DVD system and load a disc, then press OPEN/CLOSE ▲ again to close the disc tray.

Make sure the disc label is facing up. For double-sided discs, load the side you want to play face up.

4 Playback will start automatically.

If a disc menu appears, use ▲▼◀▶ buttons on the remote to make the necessary selection, then press OK to confirm. Or, use the numeric keypad on the remote to select features. Follow the instructions given in the disc menu.

5 To stop playback, press STOP ■.

No picture?

Check the AV (Audio/Video) mode on your TV.

- * Usually this channel is between the lowest and highest channels and may be called FRONT, AV IN, or VIDEO.
- * Or, you may go to channel 1 on your TV, then press the Channel down button repeatedly until you see the Video In channel.
- * Or, your TV remote control may have a button or switch that chooses different video modes.
- * See your TV manual for more details.

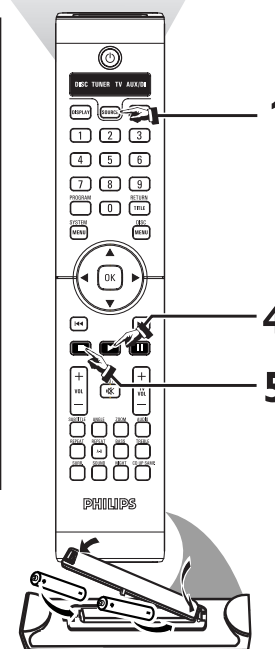

More settings and features?

Press **SYSTEM MENU** + **OK**

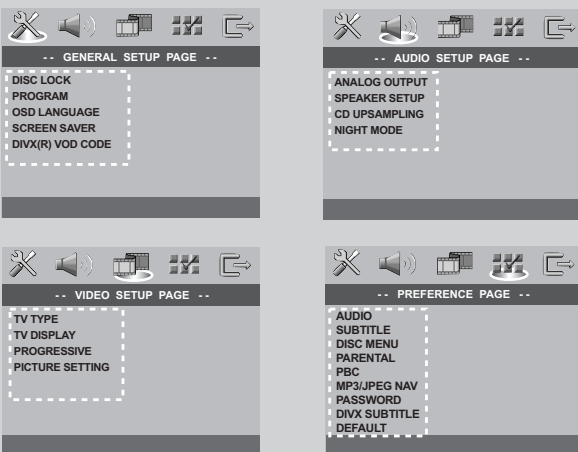

Refer to chapters "Getting Started" and "DVD Setup Menu Options" in the user manual.

No sound from rear speakers?

Press **SURR** to select 'MULTI-CHANNEL'.

Distorted sound from rear speakers?

Press and hold **SOUND** to select another transmission channel.

Enhance the sound quality?

Press **SOUND** repeatedly to select a predefined digital sound effect.

OR/AND

Press **TREBLE** or **BASS** + **VOL**

Refer to chapters "Getting Started - Setting the speakers' channel" and "Sound Controls" in the user manual.



Detailed playback features and additional functions are described in the accompanying user manual.