

**Return your Product Registration Card or register online at  
www.philips.com/usasupport today to get the very most from your purchase.**

Registering your model with PHILIPS makes you eligible for all of the valuable benefits listed below, so don't miss out. Complete and return your Product Registration Card at once to ensure:

**\* Proof of Purchase**

Returning the enclosed card guarantees that your date of purchase will be on file, so no additional paperwork will be required from you to obtain warranty service.

**\* Product Safety Notification**

By registering your product you'll receive notification - directly from the manufacturer - in the rare case of a product recall or safety defect.

**\* Additional Benefits of Product Ownership**

Registering your product guarantees that you'll receive all of the privileges to which you're entitled, including special money-saving offers.

## PHILIPS

*Congratulations on your purchase, and welcome to the "family!"*

**Dear PHILIPS product owner:**

Thank you for your confidence in PHILIPS. You've selected one of the best-built, best-backed products available today. We'll do everything in our power to keep you happy with your purchase for many years to come.

As a member of the PHILIPS "family," you're entitled to protection by one of the most comprehensive warranties and outstanding service networks in the industry. What's more, your purchase guarantees you'll receive all the information and special offers for which you qualify, plus easy access to accessories from our convenient home shopping network.

Most importantly, you can count on our uncompromising commitment to your total satisfaction.

All of this is our way of saying welcome - and thanks for investing in a PHILIPS product.

**P.S. To get the most from your PHILIPS purchase, be sure to complete and return your Product Registration Card at once, or register online at:**

**www.philips.com/usasupport**

### Know these safety symbols



 This "bolt of lightning" indicates uninsulated material within your unit may cause an electrical shock. For the safety of everyone in your household, please do not remove product covering.

 The "exclamation point" calls attention to features for which you should read the enclosed literature closely to prevent operating and maintenance problems.

**WARNING:** To reduce the risk of fire or electric shock, this apparatus should not be exposed to rain or moisture and objects filled with liquids, such as vases, should not be placed on this apparatus.

**CAUTION:** To prevent electric shock, match wide blade of plug to wide slot, fully insert.

**ATTENTION :** Pour éviter les chocs électriques, introduire la lame la plus large de la fiche dans la borne correspondante de la prise et pousser jusqu'au fond.

**For Customer Use**

Enter below the Serial No., which is located on the rear of the cabinet. Retain this information for future reference.

Model No. \_\_\_\_\_

Serial No. \_\_\_\_\_



**PHILIPS**

Visit our World Wide Web Site at <http://www.philips.com/usasupport>

## IMPORTANT SAFETY INSTRUCTIONS

### Read before operating equipment

1. Read these instructions.
2. Keep these instructions.
3. Heed all warnings.
4. Follow all instructions.
5. Do not use this apparatus near water.
6. Clean only with a dry cloth.
7. Do not block any of the ventilation openings. Install in accordance with the manufacturer's instructions.
8. Do not install near any heat sources such as radiators, heat registers, stoves, or other apparatus (including amplifiers) that produce heat.
9. Do not defeat the safety purpose of the polarized or grounding-type plug. A polarized plug has two blades with one wider than the other. A grounding type plug has two blades and third grounding prong. The wide blade or third prong are provided for your safety. When the provided plug does not fit into your outlet, consult an electrician for replacement of the obsolete outlet.
10. Protect the power cord from being walked on or pinched particularly at plugs, convenience receptacles, and the point where they exit from the apparatus.
11. Only use attachments/accessories specified by the manufacturer.
12.  Use only with a cart, stand, tripod, bracket, or table specified by the manufacturer, or sold with the apparatus. When a cart is used, use caution when moving the cart/apparatus combination to avoid injury from tip-over.
13. Unplug this apparatus during lightning storms or when unused for long periods of time.
14. Refer all servicing to qualified service personnel. Servicing is required when the apparatus has been damaged in any way, such as power-supply cord or plug is damaged, liquid has been spilled or objects have fallen into apparatus, the apparatus has been exposed to rain or moisture, does not operate normally, or has been dropped.
15. This product may contain lead or mercury. Disposal of these materials may be regulated due to environmental considerations. For disposal or recycling information, please contact your local authorities or the Electronic Industries Alliance: [www.eiae.org](http://www.eiae.org).
16. **Damage Requiring Service** - The appliance should be serviced by qualified service personnel when:
  - A. The power supply cord or the plug has been damaged; or
  - B. Objects have fallen, or liquid has been spilled into the appliance; or
  - C. The appliance has been exposed to rain; or
  - D. The appliance does not appear to operate normally or exhibits a marked change in performance; or
  - E. The appliance has been dropped, or the enclosure damaged.
17. **Tilt/Stability** - All televisions must comply with recommended international global safety standards for tilt and stability properties of its cabinets design.
  - Do not compromise these design standards by applying excessive pull force to the front, or top, of the cabinet which could ultimately overturn the product.
  - Also, do not endanger yourself, or children, by placing electronic equipment/toys on the top of the cabinet. Such items could unsuspectingly fall from the top of the set and cause product damage and/or personal injury.
18. **Wall or Ceiling Mounting** - The appliance should be mounted to a wall or ceiling only as recommended by the manufacturer.
19. **Power Lines** - An outdoor antenna should be located away from power lines.
20. **Outdoor Antenna Grounding** - If an outside antenna is connected to the receiver, be sure the antenna system is grounded so as to provide some protection against voltage surges and built up static charges. Section 810 of the National Electric Code, ANSI/NFPA No. 70-1984, provides information with respect to proper grounding of the mats and supporting structure grounding of the lead-in wire to an antenna-discharge unit, size of grounding connectors, location of antenna-discharge unit, connection to grounding electrodes and requirements for the grounding electrode. See Figure below.
21. **Objects and Liquid Entry** - Care should be taken so that objects do not fall and liquids are not spilled into the enclosure through openings.
  - a) **Warning:** To reduce the risk of fire or electric shock, this apparatus should not be exposed to rain or moisture and objects filled with liquids, such as vases should not be placed on this apparatus.
22. **Battery Usage CAUTION** - To prevent battery leakage that may result in bodily injury, property damage, or damage to the unit:
  - Install all batteries correctly, with + and - alignment as marked on the unit.
  - Do not mix batteries (old and new or carbon and alkaline, etc.)
  - Remove batteries when the unit is not used for a long time.

#### EXAMPLE OF ANTENNA GROUNDING AS PER NATIONAL ELECTRICAL CODE (NEC)

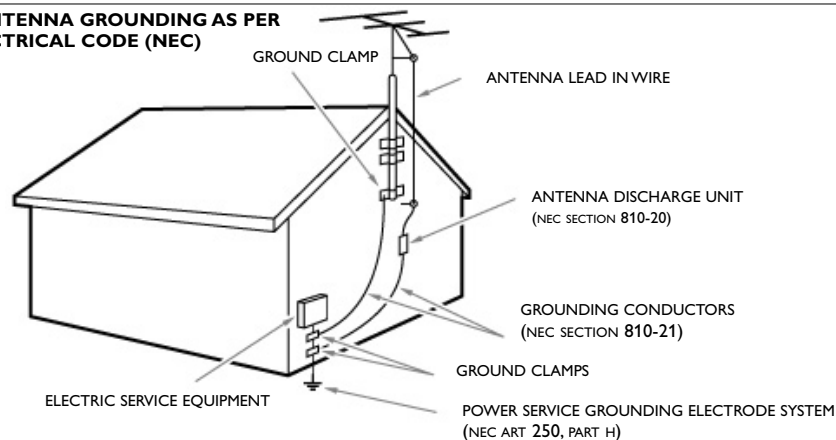

**Note to the CATV system installer:** this reminder is provided to call the CATV system installer's attention to Article 820-40 of the NEC that provides guidelines for proper grounding and, in particular, specifies that the cable ground shall be connected to the grounding system of the building, as close to the point of cable entry as practical.

## About this User Manual

This manual contains all information you will need to initially install and operate your new TV. Also read the help texts which are being displayed at the bottom of the screen.



### Help?

*If this instruction manual does not give an answer or if 'Before Calling Service' does not solve your TV problem, you can call your Local Philips Customer or Service Centre. See the supplied World-wide guarantee booklet.*

*Please, have the Model and Serial number which you can find at the back of your television set or on the packaging, ready, before calling the Philips helpline 1-888-PHILIPS (744-5477)*

Model: 63PF9631D/37; 47PF9441D/37

Serial No:

## Contents

Safety warnings	2	Connect:	
Getting started	3	a VCR or DVD recorder	47
Use of the remote control RC4405	6	a recorder and other A/V devices	48
Use of the OPTION button	9	a recorder and Cable box with RF output	49
Buttons on the right side of the TV	10	a satellite receiver or Cable box	
Turn the TV on	10	with A/V outputs	50
First time installation	10	a recorder and satellite receiver or	
How to navigate through the menus	13	Cable box with A/V outputs	51
Use of the TV menu settings	15	a DVD player, or other accessory digital	
Adjust picture menu settings	17	source devices	52
Adjust sound menu settings	20	a device to the HDMI connector	54
Adjust feature menu settings	22	a Digital Surround receiver	55
How to search for and store TV channels	30	Record with your recorder	55
Set your preferences	34	Select connected equipment	55
Select your connections	36	Audio and video equipment buttons	56
Set your clock	37	Before calling service	57
Reset AV settings	38	Glossary	58
How to upgrade the TV software	38	Annex 1 - Philips TV software upgrade	
Create your favorite list	39	with portable memory	59
Electronic Program guide	40	Annex 2 - Philips TV-Slideshow Format	
Multimedia Browser	41	with background music	61
To make video and audio connections	44	Annex 3 - Philips TV - Digital camera	
Side panel overview	45	and USB issues	63
Rear panel overview	46	Annex 4 - Issues referring to connected	
		peripherals with a HDMI connector	64
		Index	65
		Recycling	66
		Product information	67



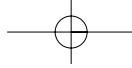

## Safety warnings

### General

**Do not insert the power plug in a wall socket or hang the TV to the wall before all connections are made.**

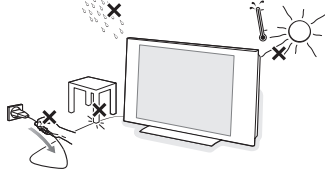

- Place or hang the TV wherever you want, but make sure that air can circulate freely through the ventilation slots. Leave at least 4" to 6" free all around the TV.
- Do not place the TV on a carpet.
- Do not install the TV in a confined space such as a book case or a similar unit.
- To prevent any unsafe situations, no naked flame sources, such as lighted candles, should be placed in the vicinity.
- Avoid heat, direct sunlight and exposure to rain or water.
- The equipment shall not be exposed to dripping or splashing.
- To prevent damaging the power (AC) cord which could cause a fire or electric shock, do not place the TV on the cord.

### Care of the screen

Do not touch, push or rub or strike the screen with anything hard as this may scratch, mar or damage the screen permanently.

And please do not rub with dust clothes with chemical treatment. Do not touch the surface with bare hands or greasy cloth (some cosmetics are detrimental to the screen).

Unplug the TV before cleaning the screen.

When the surface becomes dusty, please wipe gently with absorbent cotton or other soft materials like chamois soaks. Do not use acetone, toluene and alcohol because they cause chemical damage. Do not use liquid cleaners or aerosol cleaners. Wipe off saliva or water drops as soon as possible. Their long time contact with the screen causes deformations and color fading.

### Warning concerning stationary images on the TV screen

A characteristic of LCD and Plasma Display Panels is that displaying the same image for a long time can cause a permanent after-image to remain on the screen. Normal use of the TV should involve the showing of pictures that contain constantly moving and changing images that fill the screen.

Examples of stationary images (this is not an all-inclusive list, you may encounter others in your viewing):

- TV menus;
- Black bars: when black bars appear at the left and right side of the screen, it is recommended to change to a picture format so that the picture fills the entire screen;
- TV channel logo: present a problem if they are bright and stationary. Moving or low-contrast graphics are less likely to cause uneven aging of the screen;

- Stock market stickers: presented at the bottom of the TV screen;
- Shopping channel logos and pricing displays: bright and shown constantly or repeatedly in the same location on the TV screen.  
Examples of still pictures also include logos, computer images, time display, teletext and images displayed in 4:3 mode, static images or characters, etc.

### Notes:

- reduce contrast and brightness when viewing
- once burn-in occurs it will never disappear completely.

**Carefully pay attention to these remarks. The warranty does not apply to damage caused by not taking into account the above mentioned warnings on stationary images.**

### Caution

Installing the TV requires special skills that should only be performed by qualified personnel. You should not attempt to do the work yourself. Philips bears no responsibility for improper mounting or mounting that results in accident or injury. Make sure that the wall mount is being fixed securely enough so that it meets safety standards.

### Electric, Magnetic and Electromagnetic Fields ("EMF")

- Philips Royal Electronics manufactures and sells many products targeted at consumers, which, like any electronic apparatus, in general have the ability to emit and receive electro magnetic signals.
- One of Philips' leading Business Principles is to take all necessary health and safety measures for our products, to comply with all applicable legal requirements and to stay well within the EMF standards applicable at the time of producing the products.
- Philips is committed to develop, produce and market products that cause no adverse health effects.
- Philips confirms that if its products are handled properly for their intended use, they are safe to use according to scientific evidence available today.
- Philips plays an active role in the development of international EMF and safety standards, enabling Philips to anticipate further developments in standardization for early integration in its products.

### Pixel characteristics

Your TV display is made with high-precision technology with a high number of colour pixels. Although it has effective pixels of 99,999% or more, black dots or bright points of light (red, green or blue) may appear constantly on the screen. This is a structural property of the display (within common industry standards) and is not a malfunction.

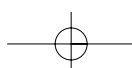

## Getting started

### Before you start

**Warning:** do not insert the power plug into the mains at the bottom of the TV and in a wall socket before all connections are made.

Before installing your TV or before hanging it on the wall, first connect your accessory devices. See To make video and audio connections, p. 44.

### Overview of the rear connector panel

There is a wide range of audio and video devices that can be connected to your TV. See To make audio and video connections, p. 44.

English  
User Manual

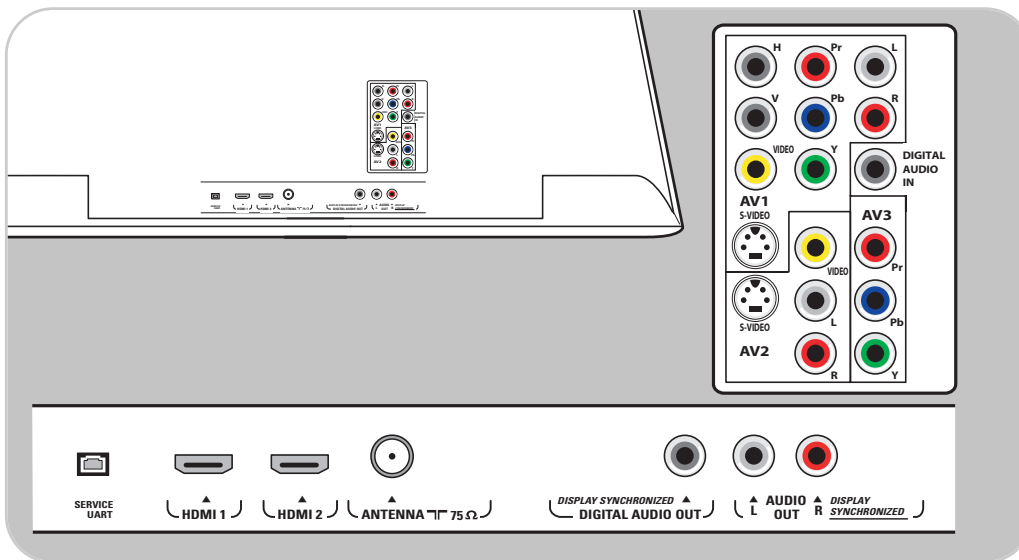

**AV1** can handle YPbPr, VIDEO, S-VIDEO, RGB-HV and L/R Audio,

**AV2** can handle VIDEO, S-VIDEO and L/R Audio,

**AV3** can handle YPbPr,

**HDMI 1** and **2** can handle Digital video and audio,

**Side** can handle VIDEO or S-VIDEO, L/R Audio and USB,

**Service UART** : For use only by authorized service personnel.

Note for installers/integrators : Do not connect RS232 without level shifter.

**Supported video formats:** 480i, 480p, 720p, 1080i.

**Warning:** disconnect all power sources before making any connections.

## Getting started (Continued)

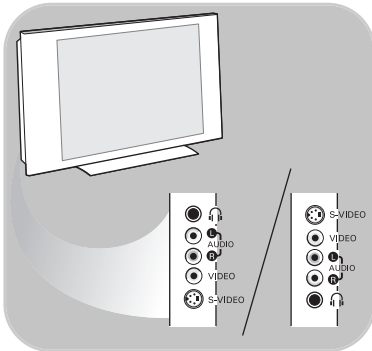

### Overview of the side connector panel

- To connect a camera, camcorder or game, see To make video and audio connections, p. 44.
- To connect a headphone, see To make video and audio connections, p. 44.
- To connect a USB device, see Multimedia browser, p. 41.

## Connect to the TV

Your Philips Digital TV will allow you to enjoy digital programs directly from your cable or off air. Connect directly to the TV or connect via your current cable box or Satellite Receiver box.

### • Directly to the TV (you will not be able to receive pay channels)

1. Connect the cable TV signal or the incoming antenna signal to the **CABLE/ANTENNA 75 Ω** jack at the bottom of the TV.
2. See page 31 for details on using Autoprogram to store channels in the TV's memory.

#### Notes:

- Broadcasters are in the middle of a transition from analog to digital TV. This means that a given broadcaster will have two channels on the air, one analog and one digital.
- This connection will supply stereo sound to the TV if it is being broadcast by the station you are watching.

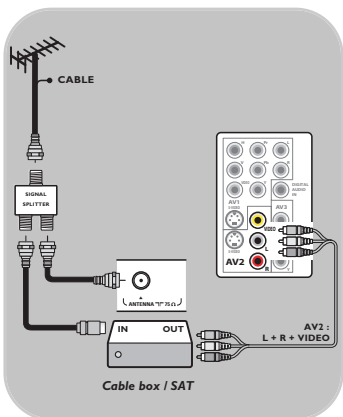
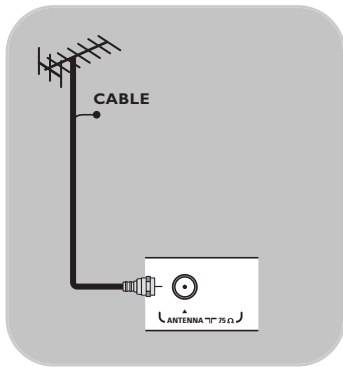

### • Via a cable box or Satellite box

1. Maintain the connection of the TV cable of your home into your cable box (or satellite receiver box).
2. Connect your Cable box (or satellite receiver box) to the back of the TV using the best connection options. See to make audio and video connections, p. 44.
3. Select the source using the **AV** button on the remote control.
4. Press the **OK** button to confirm your selection.

For more information, please refer to your cable box (or satellite receiver box) manual.

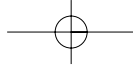

## Getting started (Continued)

### **Note: Watching Cable TV programs that don't require the cable box**

Since you've connected the cable TV signal directly to the TV's tuner, you can also watch the unscrambled programs by simply tuning to the desired channel. You must first use Autoprogram, however, to store channels in the TV's memory. See page 34. This connection will supply stereo sound to the TV if it is being broadcast by the station you are watching.

English  
User Manual

## Connect the mains

- Insert the power cord supplied into the mains at the bottom of the TV and in the wall socket.

**Warning:** verify that the power supply voltage corresponds to the voltage printed on the sticker at the back of the TV. Contact your local dealer if your power supply is different.

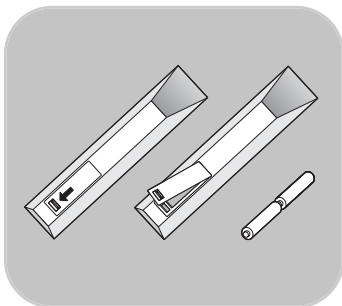
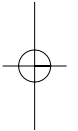
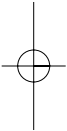

### **Remote control**

- Insert the 2 batteries supplied (Type R6-1,5V). Be sure the (+) and (-) ends of the batteries line up correctly (inside of case is marked.)

For most buttons pressing a button once will activate the function. Pressing a second time will de-activate it.

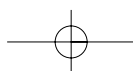

## Use of the remote control RC4405

**Attention:** this remote control can not be programmed to work accessory devices.

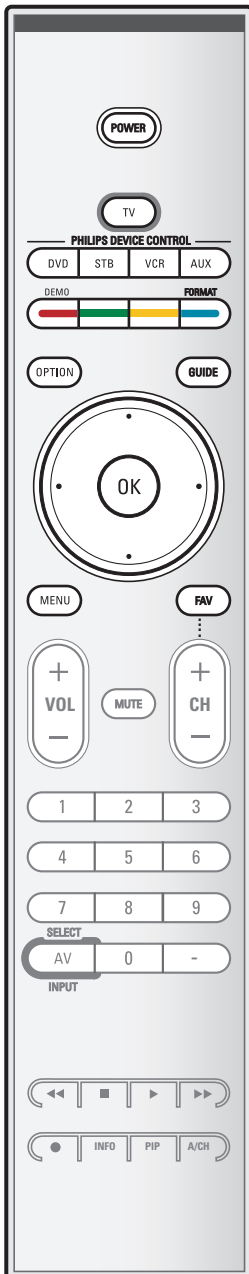

### POWER

Press to turn on/off the TV from or to standby mode.

**Attention:** the TV is never powered off completely unless it is physically unplugged.

**TV** Press to select TV mode.

### DVD STB VCR AUX

Press to select one of the system modes in which the remote control can be used.

### DEMO Demo on/off

See p. 29.

### Color buttons

When functions are attached to the color buttons, the color buttons are shown on screen.

### OPTION

To open and close the Quick access menu which contains a few frequently used options, like Closed captions, Picture format,...

### GUIDE

To open and close the Electronic Program Guide. See EPG (Electronic Program Guide) p. 40.

### Cursor buttons

Press the cursor buttons up/down, left/right to navigate through the menus.

**Note:** If necessary (in some cases), you can adjust the picture position to the center of the screen with the cursor buttons.

**OK** - to activate a setting

- to display the list of channels stored (according to the selection made in the Installation mode - Antenna or Cable, p. 31.)

- starts playing content in the Multimedia Browser application, p. 41.

**MENU** Settings menu on/off. See p. 13.

**FAV** - to display the channel list

- you can create up to four favorite lists.

## Use of the remote control RC4405 (Continued)

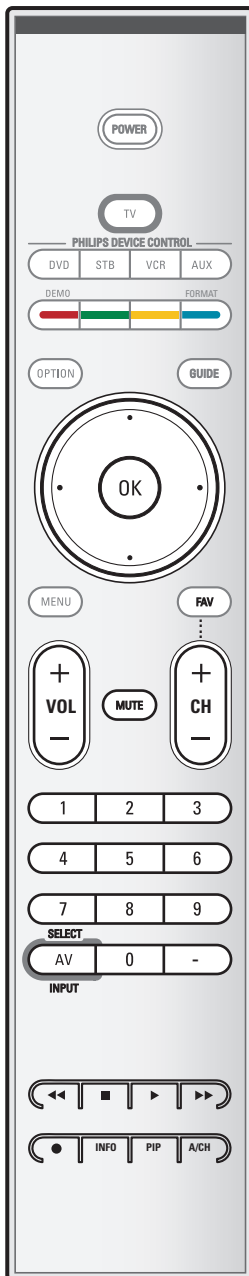

### **VOL Volume**

Press + or - to adjust the volume.

### **MUTE**

Interrupt the sound or restore it.

### **CH Channel selection**

- To browse through the TV channels or sources stored and marked in the selected Favorite channels list (see p. 39);
- To quickly browse through the list in the menus;
- To select between Antenna or Cable TV channels, first make your selection in the Installation menu, Channels, Installation mode, see p. 33.

**Note:** You don't have to start the installation again once you have searched for and stored the available TV channels.

### **Numeric buttons**

To select a TV channel.

**SELECT AV INPUT** Press repeatedly to select **AV1, AV2, AV3, HDMI, Side** or **TV channels** when in TV mode, according to where you connected the accessory devices (p. 44).

- Type the dash (-) for digital channels.

### **◀◀ ■ ▶▶ ● Audio and Video equipment buttons**

See Audio and Video equipment buttons, p. 56.

See Multimedia browser functional buttons, p. 43.

### **INFO**

Display information: Press to display (when available) information about the selected TV channel and program or accessory device.

**PIP** no function

### **A/CH**

Press to alternate between the currently viewed channel and the previously viewed channel.

## Use of the remote control RC4405 (Continued)



### FORMAT

Press this button to summon a list of available display formats (depending on the receiving signal). This lets you choose the display format of your preference.

Press this button repeatedly to select another picture format: Automatic, Super zoom, 4:3, Movie expand 14:9, Movie expand 16:9 or Wide screen.

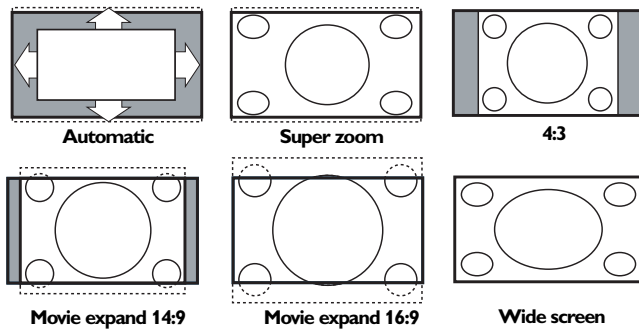

Automatic makes the picture fill the screen as much as possible.

Super zoom removes the black bars on the sides of 4:3 programs with minimal distortion.

When in Movie expand 14:9, Movie expand 16:9 or Super zoom picture format, you can make subtitles visible with the cursor up/down.

**Note:** With HD sources not all screen formats will be available.

## Use of the **OPTION** button



The **OPTION** button allows you to display the Quick access menu which will give you direct access to some features and menu options.

1. Press the **OPTION** button.
  - ▷ The Quick access menu appears.
2. Press the cursor up/down to select a menu item.
3. Press the **OK** button to jump to the selected menu item in the TV menu (except for the clock option).
4. Use the cursor buttons to make a selection.
5. Press the **OPTION** button to exit.

**Note:** digital related menu items will only be accessible in case of digital TV broadcasting.

English  
User Manual

### Audio language

See Adjust Sound menu settings, p. 20.

### Closed captions

See Adjust Feature menu settings, p. 22.

### Picture format

See Adjust Picture menu settings, p. 19, or Use of the remote control, Format button, p. 8.

### Equalizer

See Adjust Sound menu settings, p. 20.

### Clock

Select to activate/deactivate the clock display on the screen.

Quick access
Audio language
Closed captions
Picture format
Equalizer
Clock

## Buttons on the right of the TV

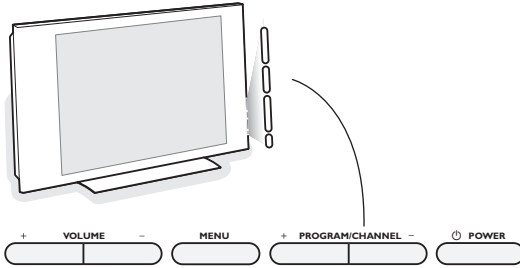

Should your remote be lost or broken you can still change some of the basic settings with the buttons on the right side of your TV. Press the power switch  to switch the TV on.

The **MENU** button can be used to summon the **TV** menu without the remote control.

Use the **VOLUME +** and **-** buttons and the **PROGRAM/CHANNEL +** and **-** buttons to select menu items.

## Turn the TV on

- Press the power switch  at the right side of the TV.
  - An indicator on the front of the TV lights up.
- Press the **+CH-** button or the **POWER** button on the remote control.

**Note:** the first time (and only the first time) you turn on your TV, you see a Welcome screen followed by the installation procedure. See First time installation below.

## First time installation

The installation procedure consists of a series of screens that will guide you through the installation of your TV. Follow the instructions on screen.

**Note:** if the TV has already been installed before and/or you want to change the First time installation settings, proceed with Use of the TV menu settings, p. 15.

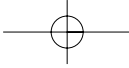

## First time installation (continued)



### Step 1: select your on-screen language

After the Welcome screen you are asked to select a language of the TV's on-screen menus. The text of the header and the info on screen continuously change language.

1. Press the cursor up/down to highlight your language.
2. Press the **OK** button on the remote control.
3. Follow the instructions on screen to proceed.

English  
User Manual

### Step 2: complete the initial TV installation procedure

1. Press the green color button on your remote control to start the television installation.
2. Select **Cable** or **Antenna** in the Installation mode and press the green color button.
  - ▷ When **Antenna** is selected, the TV will detect antenna signals and will search for antenna TV (NTSC and ATSC) channels available in your local area.
  - ▷ When **Cable** is selected, the TV will detect cable company supplied signals and will search for cable TV (NTSC, ATSC, QAM modulated) channels available in your area.
3. Press the green color button on your remote control to start the Automatic channel installation.
  - ▷ All available TV channels are searched for and stored automatically. This will take a few minutes. When the search is complete, the menu will indicate the number of digital and analog channels found.

**Note:** if you choose to install the channels at a later time, select Autoprogram in the TV menu, Installation, Channels to scan available channels.

4. Press the red color button when the search is completed.

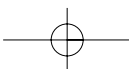
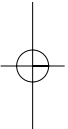
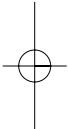
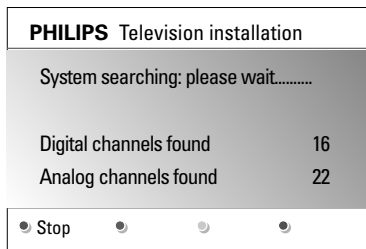
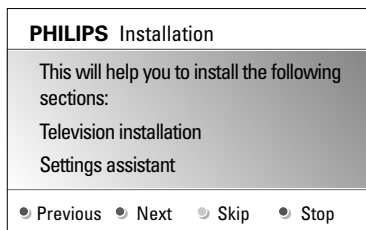
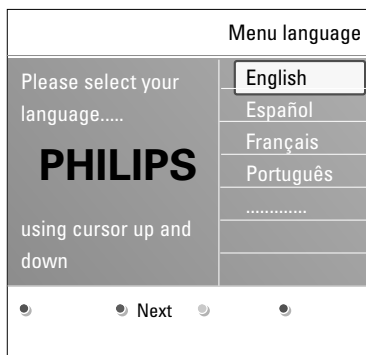

## First time installation (Continued)

### Step 3: Settings assistant: select your TV settings

By means of several split screens/full screens you are prompted to select your preferred picture and sound settings, to finally arrive at a complete setting which satisfies you.

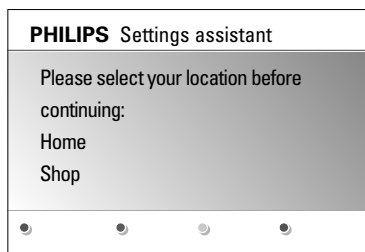

1. Press the green color button on your remote control to enter the **Settings assistant** menu.
2. Select your Location with the cursor up/down and press the green color button.
  - ▷ If you choose **Shop** it will skip the Settings assistant. The TV parameters for Picture and Sound will then be set to predefined fixed settings. Press the green color button again to proceed.
  - ▷ If you choose **Home** it will display the Settings assistant.
3. Use the cursor left/right to each time select your preferred screen.
4. Press the green color button to each time confirm your selection and to jump to the following screen.
  - ▷ The following items will be presented sequentially. In the header it is mentioned how many screens have been completed and how many screens there are in total. The Settings assistant will step sequentially through the following settings: Picture and Sound.
5. Press the green color button twice to store all the settings and to return to the TV installation menu.

**Note:** when you skip or stop the Settings Assistant, then the Standard settings Philips selected for you will be chosen.

6. Press the red color button to finish the First time installation procedure and to display the first stored TV channel.

**Note:** any time you can change or reset your settings or adjust individual settings for Picture and Sound in the TV settings menu.  
See p. 15, Use of the TV menu settings.  
To control the settings of special TV functions, features and accessory equipment.  
See p. 22, Adjust feature menu settings.

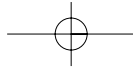

## How to navigate through the menus

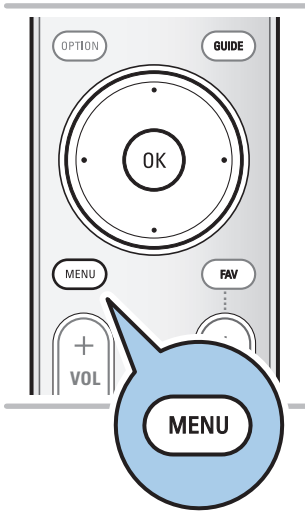

### Introduction

A lot of guiding instructions, help texts and messages will be displayed on your TV when you use the menus or when you try to execute an action.

Read the help texts which are being displayed on the specific item highlighted.

The color button at the bottom of the screen refer to the different actions which may be executed.

Press the corresponding color button on the remote control to perform the required or desired action.

English  
User Manual

1. Press the **MENU** button on the remote control.
  - The main menu appears on the screen.
    - **TV menu** allows you to access the TV menu. See below.
    - **Channel list** allows you to access the TV channel list and to create up to four favorite lists with your preferred TV channels. See Create your favorite channel list, p. 39.
    - **Multimedia** allows you to access the Multimedia browser application. It lets you display your personal multimedia files. Multimedia is only present when a USB device is connected. See Multimedia browser, p. 41.
2. Use the cursor up/down to highlight and select a menu item.
3. Use the cursor right to enter the highlighted menu item.
  - The right panel shows the content of the highlighted menu item.



TV menu	TV settings
TV settings	Settings assistant
Features	Reset to standard
Installation	Picture
	Sound
Info	

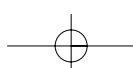
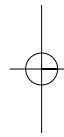
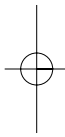

## How to navigate through the menus (continued)

TV menu	TV settings
TV settings	Settings assistant
Features	Reset to standard
Installation	Picture
	Sound
Info	

4. Use the cursor up/down to select a menu item.
  - **TV settings** allows you to adjust your preferred picture and sound settings
  - **Features** allows you to control the settings of special TV features
  - **Installation** allows you
    - to select your menu language;
    - to search for and store your TV channels;
    - to do a weak ATSC digital channel installation;
    - to set or adjust various special functions;
    - to select connected peripheral equipment;
    - to reset your picture and sound settings to the factory standard settings;
    - to upgrade your TV software.
5. Press the cursor right to enter the highlighted menu item.
  - The content of the right panel is moved to the left panel and the right panel now shows the content of the newly highlighted item in the left panel.

**Note:** in some cases it is important that the picture can be watched while you adjust the settings. This means that when the highlight is on the right side panel, the other menu items hide away. When the cursor left is pressed, the hidden menu items reappear and the highlight moves to the left panel.

6. Press the **MENU** button to exit the main menu.

## Use of the TV menu settings

Television	TV menu
	Channel list
Multimedia	

The TV menu allows you to access and change settings and preferences in case you want to change the First time installation settings and/or you want to control the settings of special TV functions, features and peripheral equipment.

TV menu	TV settings
TV settings	Settings assistant
Features	Reset to standard
Installation	Picture
	Sound
Info	

### Adjust viewing and listening settings

1. Press the **MENU** button on the remote control.
  - The main menu appears on the screen.
2. Select **TV menu** and press the cursor right.
  - The TV menu is displayed.
3. Select **TV settings** and press the cursor right.
  - The TV settings menu is moved to the left.
4. Press the **MENU** button to exit the menu.

To make it easier to change the settings of the TV, there are 3 ways of doing it.

### A. Change settings in an easy-to-use manner with the Settings assistant

Each time you've made a selection, press the green color button to confirm your selection.

1. Select **Settings assistant** and press the cursor right.
  - By means of several split screens/full screens you are prompted to select your preferred picture and sound settings to finally arrive at a complete setting which satisfies you.  
See First time installation, Step 3: Settings assistant: select your TV settings, p. 12.
2. Press the green color button to return to the TV menu again.

## Use of the TV menu settings (continued)

TV menu	
TV settings	Reset to standard
Settings assistant	Current
Reset to standard	Natural
Picture	Vivid
Sound	Subtle
Info	

### B. Use of the Standard settings

This allows you to reset your settings for viewing and listening to predefined factory settings.

1. Select **Reset to standard** and press the cursor right.
  - ▷ A menu appears which allows you to select one of the standard settings for viewing and listening.
  - ▷ **Current** shows your current settings for viewing and listening.
  - ▷ If you select **Natural**, it allows you to set your picture and sound settings to the recommended standard values. In most cases this will give the best balanced viewing experience.
  - ▷ If you select **Vivid**, it allows you to set your picture and sound settings to rich values, making use of the TV capabilities to its full extend.
  - ▷ If you select **Subtle**, it allows you to set your picture and sound settings to the purest representation of the original source content.
2. Press the green color button to store the selected setting.

### C. Individual settings for picture and sound

- Select **Picture** or **Sound** and press the cursor right.
  - ▷ A menu appears which allows you to fine tune the picture and sound settings.
  - ▷ To adjust the Picture settings, see Adjust picture menu settings, p. 17.
  - ▷ To adjust the Sound settings, see Adjust sound menu settings, p. 20.

## Adjust picture menu settings

TV menu	TV settings
TV settings	Settings assistant
Features	Reset to standard
Installation	Picture
	Sound
Info	

TV menu	TV settings	Picture
Settings assistant	Contrast	
Reset to standard	Brightness	
Picture	Color	
Sound	Tint	
	Sharpness	
	Color temperature	
	.....	
Info		

The picture menu contains the settings that affect the quality of the picture.

1. Press the **MENU** button on the remote control.
  - The main menu appears.
2. Select **TV menu** and press the cursor right.
  - The TV menu is moved to the left.
3. Select **TV settings** and press the cursor right.
  - The TV settings menu is moved to the left panel.
4. Select **Picture** and press the cursor right.
  - The Picture menu is moved to the left panel.
5. Use the cursor up/down to select the Picture menu items.
6. Press the cursor right to enter the selected Picture menu item.
7. Use the cursor buttons to adjust the settings.
8. Press the cursor left to return to the Picture menu.

### Contrast

Adjusts the intensity of bright parts in the picture but keep the dark parts unchanged.

### Brightness

Adjusts the light output of the complete picture, which will mainly affect the darker areas of the picture.

### Color

Adjusts the saturation level of the colors to suit your personal preference.

### Tint

Allows you to select the color mix (tint) of the picture.

### Sharpness

Adjusts the sharpness of fine details in the picture.

### Color temperature

Increases or decreases **Warm** (red) and **Cool** (blue) colors to suit personal preferences.

- Select **Cool** to give the white colors a blue, **Normal** to give the white colors a neutral, **Warm** to give the white colors a red tint.
- Select **Custom** to make a customized setting in the Custom color temperature menu item.

## Adjust picture menu settings (Continued)

TV menu	
TV settings	Picture
Settings assistant	.....
Reset to standard	Custom color temp.
Picture	Pixel Plus
Sound	Dynamic contrast
	DNR
	.....
Info	

### Custom color temperature (only when Color temperature is set to Custom)

Fine tunes the white point (**WP**) and black level (**BL**) of the picture.

1. Select **Custom color temperature** and press the cursor right.
2. Use the cursor buttons to select and adjust the settings of:

**R-WP**: allows you to customize the color temperature by adjusting the red whitepoint of the picture.

**G-WP**: allows you to customize the color temperature by adjusting the green whitepoint of the picture.

**B-WP**: allows you to customize the color temperature by adjusting the blue whitepoint of the picture.

**R-BL**: allows you to customize the color temperature by adjusting the red blacklevel of the picture.

**G-BL**: allows you to customize the color temperature by adjusting the green blacklevel of the picture.

3. Use the color button to reset to the predefined settings.
4. Press the cursor left to return to the Picture menu.

### Pixel Plus

Pixel Plus is the most ideal setting, as it fully processes the image to make every single pixel the best it can be, improving contrast, sharpness, picture depth, and color reproduction and brilliance from every source, including High Definition.

- Select **On** or **Off** to activate/de-activate Pixel Plus.

### Dynamic contrast

Automatically makes the contrast in the darker and the brighter picture areas more noticeable as the image on the screen changes.

- Normally select **Medium**. It may be preferred to select **Minimum**, **Maximum** or **Off**.

### DNR

**DNR** automatically filters out and reduces the image noise. This improves picture quality when receiving weak signals.

- Select **Off**, **Minimum**, **Medium** or **Maximum** according to the image noise in the picture.

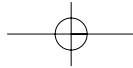

## Adjust picture menu settings (Continued)

TV menu	
TV settings	Picture
Settings assistant	.....
Reset to standard	MPEG artifact red...
Picture	Color enhancem..
Sound	Active control
	Picture format
Info	

### MPEG artifact reduction

**MPEG artifact reduction On** smoothens the transitions on digital content.

- o Select **On** or **Off**.

### Color enhancement

Automatically controls green enhancement and blue stretch. It makes the colors more vivid.

- o Select **Off**, **Minimum**, **Medium** or **Maximum**.

### Active control

The TV continuously measures and corrects all incoming signals in order to provide the best picture possible.

- o Select **On** or **Off** to activate/de-activate Active control

### Picture format

This allows you to adjust the size of the picture dependent on the broadcasted format and your preferred setting.

**Tip:** this function is also accessible via the **OPTION** button on the remote control.

How to navigate through the TV settings menu, see p. 12:

Use of the TV menu settings.

Choose among the following picture formats: Automatic, Super zoom, 4:3, Movie Expand 14:9, Movie Expand 16:9 or Wide screen.

Automatic makes the picture fill the screen as much as possible.

In case of subtitles in the bottom black bar, Automatic makes the subtitles visible.

In case of a broadcaster logo in the corner of the top black bar, the logo disappears from the screen.

Super zoom removes the black bars on the sides of 4:3 programs with minimal distortion.

When in Movie Expand 14:9, Movie Expand 16:9 or Super zoom screen format, you can make subtitles visible with the cursor up/down.

**Note:** with HD sources not all picture formats will be available.

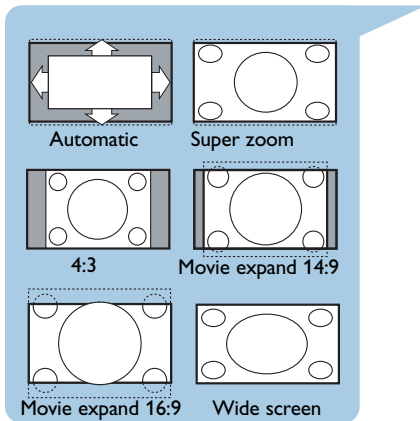

English  
User Manual

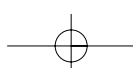
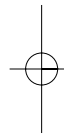
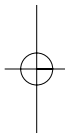

## Adjust sound menu settings

TV menu	
TV settings	Sound
Settings assistant	Equalizer
Reset to standard	Volume
Picture	Balance
Sound	Dig. audio lang...
	Alternate audio
	Mono/Stereo
	.....
Info	



Manufactured under license from Dolby Laboratories. 'Dolby' 'Pro Logic' and the double-D symbol are trademarks of Dolby Laboratories.

The sound menu contains the settings that affect the quality of the sound.

1. Press the **MENU** button on the remote control.
  - ▷ The main menu appears.
2. Select **TV menu** and press the cursor right.
  - ▷ The TV Menu is moved to the left.
3. Select **TV settings** and press the cursor right.
  - ▷ The TV settings menu is moved to the left panel.
4. Select **Sound** and press the cursor right.
  - ▷ The Sound menu is moved to the left panel.
5. Use the cursor up/down to select the Sound menu items.
6. Press the cursor right to enter the selected Sound menu item.

**Note:** dependent on the input signal, one or more menu items may not be selectable.

7. Use the cursor buttons to adjust the settings.
8. Press the cursor left to return to the Sound menu.

### Equalizer

Allows you to change the frequency response of the sound to match your personal taste.

**Tip:** this function is also accessible via the **OPTION** button on the remote control.

### Volume

Allows you to adjust the sound output level.

### Balance

Allows you to adjust the output of the right and left speakers to obtain the best stereo reproduction for your listening position.

### Audio language

Allows you to select an audio language out of the list of the available broadcasted languages.

**Note:** if there is more than one variant for an audio language, then select one of the variants. To permanently change the audio language, use the Language menu in the Installation menu.

**Tip:** this function is also accessible via the **OPTION** button on the remote control.

## Adjust sound menu settings (Continued)

TV menu	
TV settings	Sound
Settings assistant	.....
Reset to standard	Mono/Stereo
Picture	Sound mode
Sound	Headphone volume
	AVL
	Delta volume
	Auto surround
Info	

### **Alternate audio** (only selectable with analog broadcast signals)

Gives you the possibility to swap between the **Main** and **Second audio Program (SAP)** when it is available.

### **Mono/Stereo**

Allows you to select, per TV channel, **Mono** or **Stereo** sound when analog stereo broadcasts are available.

### **Sound mode**

Allows you to select the modes for more spatial or surround sound reproduction dependent on the broadcasted signals or signals from external inputs received.

### **Headphone volume**

Allows you to control the level of sound through the headphones.

### **AVL (Auto Volume Leveling)**

Automatically reduces the volume differences between channels and programs, providing a more constant overall level. This will also reduce the dynamics of sound.

### **Delta volume**

Allows you to correct for any permanent volume differences between TV channels or external sources.

### **Auto surround**

When switched **On**, this allows the TV to automatically switch to the best surround sound mode the broadcaster transmits.

## Adjust feature menu settings

TV menu	Features
TV settings	Closed captions
<b>Features</b>	Caption service
Installation	Dig.caption service
	Dig.caption options
	Sleeptimer
	.....
Info	

The Features menu allows you to control the settings of special TV functions, features and accessory equipments.

1. Press the **MENU** button on the remote control.
  - ▷ The main menu appears.
2. Select **TV menu** and press the cursor right.
  - ▷ The TV Menu is moved to the left.
3. Select **Features** and press the cursor right.
  - ▷ The Features menu is moved to the left panel.
4. Use the cursor up/down to select the Features menu items.
5. Press the cursor right to enter the selected Features menu item.
6. Use the cursor buttons to adjust the settings.
7. Press the cursor left to return to the Features menu.

### Closed captions

This displays the transmitted CC- or CS-text on the screen according to your chosen CC or CS service in the Caption or Digital caption service menu below. This text can either be permanently displayed (assuming that the service is available in the broadcast) or only when mute is active.

1. Press the cursor right after having selected **Closed captions**.
2. Select **On, Off** or **On during mute**.

### Caption service

This allows you to select the Closed Captions service levels of analog broadcasting to be displayed. Closed Captioning allows you to read the voice content of television programs on the TV screen. Designed to help the hearing impaired, this feature uses on-screen 'text boxes' to show dialogue and conversations while the TV program is in progress. Captions will appear on the screen during captioned broadcasts.

1. Select **Caption service**.
2. Press the cursor right.
3. Select the desired Caption service:
  - ▷ **CC 1, 2, 3 or 4**  
Dialogue (and descriptions) for the action on the captioned TV program shows on screen. Usually CC 1 is the most used. CC 2 may be used for alternate languages if they are being transmitted.
  - ▷ **T 1, 2, 3 or 4**  
Often used for channel guide, schedules, bulletin board information for Closed Captions programs, news, weather informations or stock market reports.

Not all Caption services are necessarily being used by a TV channel during the transmission of a Closed Caption program.

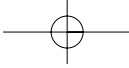

## Adjust feature menu settings (continued)

### Notes:

- This television provides display of television closed captioning conforming with the EIA-608 standard and in accordance with Sections 15.119 of the FCC rules.
- The captions do not always use correct spelling and grammar. Not all TV programs and product commercials are made for broadcast with Closed Caption informations included. Refer to your area's TV program listings for the TV channels and times of Closed Caption shows. The captioned programs are usually noted in the TV listings with service marks such as 'CC'.

TV menu	Features
TV settings	Closed captions
Features	Caption service
Installation	Dig.caption service
	Dig.caption options
	Sleeptimer
	.....
Info	

### Digital caption service

This allows you to configure the way you choose to view the digital captioning.

- o Select one of the digital service channels made available by the caption provider.  
There are 6 standard services.
  - **CS 1** is designated as the Primary Caption Service. This service contains the verbatim, or near-verbatim captions for the primary language being spoken in the accompanying program audio.
  - **CS 2** is designated as the Secondary Language Service. This service contains captions in a secondary language which are translations of the captions in the primary Caption Service.
  - The other service subchannels are not pre-assigned. It is up to the discretion of the individual caption provider to utilize the remaining service channels.

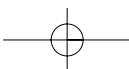
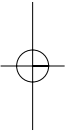
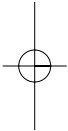

## Adjust feature menu settings (continued)

TV menu	Features
TV settings	Closed captions
<b>Features</b>	Caption service
Installation	Dig.caption service
	Dig.caption options
	Sleeptimer
	.....
Info	

### Digital caption options

This allows you to modify how digital captions are displayed on your TV.

- Select from the following options to change the visual characteristics of your TV's digital captioning.
  - **Reset to default**  
Select this option to reset the digital caption options back to the captions provider default settings.
    - Press the cursor right and press the ok button to confirm.
  - **Size**  
Select this option to select the size of caption display according to your own preference.
    - Select **Default** (Automatic), **Small**, **Standard** or **Large**.
  - **Style**  
Select this option to select the font style of caption display according to your own preference.
    - Select **Default**, **Monospaced serif**, **Serif**, **Monospaced sans serif**, **Sans serif**, **Casual**, **Cursive** or **Small caps**.
  - **Text**  
Select this option to select the text color or the opacity of the text box of caption display according to your own preference.
    - Select a color and one of the opacity options.
  - **Background**  
Select this option to select the character background color or one of the background opacity options of caption display according to your own preference.
    - Select a color and one of the opacity options.
  - **Edge color**  
Allows you to select the edge color of caption display according to your own preference.
    - Select a color.
  - **Edge type**  
Allows you to select the edge type of caption display according to your own preference.
    - Select a type.

### Sleeptimer

This sets a time period after which the TV automatically turns to standby.

1. Select **Sleeptimer**.
2. Press the cursor right.
3. Select a value with the cursor up/down. The list will have values from **0** to **180 minutes**.  
You can always turn off your TV earlier or select another time set.

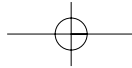

## Adjust feature menu settings (continued)

TV menu	Features
TV settings	.....
<b>Features</b>	Sleeptimer
Installation	Childlock
	Set/Change PIN
	On timer
	Demo
Info	

TV menu/Features	
Child lock	Lock after
<b>Lock after</b>	Timer
Channels lock	Time
TV ratings lock	
Movie ratings lock	
Region ratings lock	
Clear region ratings	
Info	

Age-based rating	Content-based rating
All	none
None	none
TV-Y	none
TV-Y7	(FV) Fantasy Violence
TV-G	none
TV-PG	(D) Dialog (L) Language (S) Sex (V) Violence
TV-14	(D) Dialog (L) Language (S) Sex (V) Violence
TV-MA	(L) Language (S) Sex (V) Violence

### Childlock

With a 4-digit code, you are able to lock TV channels and external sources to prevent children from watching certain programs.

1. Select **Childlock**.
2. Press the cursor right to enter the Childlock menu.
3. Enter your 4-digit code.

**Note:** you have to re-enter your code each time you enter the Childlock menu.

4. Select one of the menu items of the Childlock menu and press the cursor right.

### Lock after

**Note:** Lock after is only selectable if time and date are known. See Set your clock menu, p. 37.

This allows you to prevent the viewing of the selected channel after a selectable time delay. Locked channels can still be tuned, but the picture is blanked and the audio is muted.

1. Press the cursor right and select **Timer On** or **Off**.
  - ▷ When set to **On** this allows you to set the clock.
2. Select **Time** and press the cursor right.
  - ▷ This allows you to set the time after which the lock is set.
3. Select **AM** or **PM** to select the correct period of the day.
4. Enter the time with the digit or the cursor buttons.

### Channel lock

This allows you to completely lock a certain TV channel or external source.

- o Select the channels or subchannels you want to lock.

### TV ratings lock

Your TV is equipped with a V-chip. This allows you to control access to individual programs based on their movie and TV ratings. All settings apply to all AV inputs, except HDMI. The program content advisory data are sent by the broadcaster or program provider.

1. Select **TV ratings lock** with the cursor down.
  - ▷ A list appears, showing the age-based TV ratings and a corresponding content-based ratings list.
2. Press the cursor right to enter the list.
3. Select an age-based TV rating with the cursor up/down, and enter, if present, the list with content-based ratings with the cursor right, and select one content-based rating.
4. Press **OK** to activate/de-activate the selected rating.
5. Select another content-based rating if you like and press **OK** again.

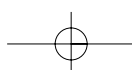
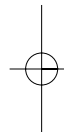
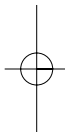

## Adjust feature menu settings (continued)

When **All** has been selected, all items in the age-based and in the contents-based lists are locked.

If, while **All** is selected, any other item, either an age-based or content-based item, is unselected, then All is automatically unselected.

**No rating** is the selection for items that either have no rating information or have a rating of None. Both will be locked.

When an item on the age-based list is selected, all items below that item of the same group are locked as well.

When you select a content-based rating, all identical content-based ratings in the older age-based categories are also selected.

### Notes:

- You can lock/unlock any number of ratings on the list without re-entering your code.
- Each ratings item has a box-graphic in front of it to indicate whether or not programs carrying that rating are currently locked.

### TV ratings

<b>TV-Y</b>	appropriate for children of all ages with themes and elements suitable for children aged 2-6
<b>TV-Y7</b>	programs designed for children age 7 and older
<b>TV-Y7-FV</b>	programs include fantasy violence more intense than other programs in the TV-Y7 category
<b>TV-G</b>	programs suitable for all ages. These programs contain little or no violence, no strong language and little or no sexual dialogue or situations
<b>TV-PG</b>	programs contain elements that some parents may find unsuitable for younger children and which may need parental guidance. The program may contain moderate violence, sexual dialogue and/or situations and some strong language.
<b>TV-14</b>	programs contain elements that may not be suitable for children under 14 years of age. These programs include one or more of the following: intense violence, intense sexual situations, suggestive dialogue and strong language.
<b>TV-MA</b>	programs are designed to be viewed by adults and may be unsuitable for children under the age of 17. These programs may contain graphic violence, explicit sexual activity and/or crude or indecent language.

## Adjust feature menu settings (continued)

TV menu/Features	
Child lock	Movie ratings lock
Lock after	
Channels lock	
TV ratings lock	Please enter your
Movie ratings lock	PIN.
Region ratings lock	
Clear region ratings	
Info	

### Movie ratings lock

This function allows you to control access to individual movies based on their MPAA ratings (Motion Picture Association of America).

1. Select **Movie ratings lock** with the cursor down. A list appears, showing all valid MPAA content ratings.
2. Press the cursor right to enter the list.
3. Select a movie rating with the cursor up/down.
4. Press **OK** to activate/de-activate the selected rating.

Each rating item has a box-graphic in front of it to indicate whether or not programs carrying that rating are currently locked.

When **All** has been selected, all items on the movie ratings list become selected. (All movies are locked.)

If, while **All** is selected, any other item is unselected, then **All** is automatically unselected.

When any other item has been selected, all ratings below are selected as well, thus all movies with those ratings will be locked.

### Movie ratings

<b>NR</b>	not rated
<b>G</b>	movies with a mild content, suitable for all ages
<b>PG</b>	movies for which parental guidance is recommended. They may contain a few racy or violent scenes or maybe some bad language
<b>PG-13</b>	movies for which parental guidance may be recommended if under age 13
<b>R</b>	restricted. The movies usually contain offensive sex or bad language and may be unsuitable for children under the age of 17. Parental guidance or permission needed.
<b>NC-17</b>	even with parental permission, forbidden under age 17. More offensive sex, violence or bad language.
<b>X</b>	movies which generally focus on sex, violence and/or bad language. Also known as pornography.

## Adjust feature menu settings (continued)

TV menu/Features	
Child lock	Region ratings lock
Lock after	
Channels lock	
TV ratings lock	Please enter your
Movie ratings lock	PIN.
Region ratings lock	
Clear region ratings	
Info	

### Region ratings lock (if present)

This allows you to control access to individual programs based on their broadcasted regional rating.

1. Select **Region ratings lock** with the cursor down.
  - A list appears, showing all valid region ratings.
2. Press the cursor right to enter the list.
3. Select a region rating with the cursor up/down.
4. Press the **OK** button to activate the selected rating.
5. Select another region rating if you like and press **OK** again.
6. Press the cursor left to return to the **Child lock** menu.

### Clear region ratings (if present)

This allows you to clear all the locks you have set in the Region ratings lock table.

1. Select **Clear region ratings** with the cursor down.
2. Press the cursor right.
3. Press the **OK** button to activate.
4. Press the cursor left to return the **Child lock** menu.

### Set/Change PIN

This allows you to set or change the personal 4-digit access code that is used in the different lock functions of the TV.

1. Select **Set or Change PIN** with the cursor down.
  - If no PIN-code exists yet, the menu item is set to **Set PIN**. Follow the instructions on screen.
  - If a PIN-code has previously been entered, the menu item is set to **Change PIN**. Follow the instructions on screen.
2. Enter your PIN with the digit buttons.  
All number combinations from 0000 to 9999 are valid numbers.
3. The **Menu preferences** menu reappears with a message confirming that the PIN has been created.

#### Important: you have forgotten your PIN!

1. Select **Change PIN** in the Features menu.
2. Press the cursor right to enter the overriding PIN code 0-7-1-1.
3. Enter a new personal 4-digit PIN code. The previous code is erased and the new PIN-code is stored.

TV menu	Features
TV settings	.....
Features	Sleeptimer
Installation	Childlock
	Set/Change PIN
	On timer
	Demo
Info	

## Adjust feature menu settings (continued)

TV menu	Features
TV settings	.....
<b>Features</b>	Sleeptimer
Installation	Childlock
	Set/Change PIN
	On timer
	Demo
Info	

### On timer

From standby, this automatically turns the TV to the specified channel number, at a specified time.

1. Select **On timer**.
2. Press the cursor right to enter the On timer menu.
3. Select **Timer** and press the cursor right.
4. Select **On**.
5. Select **Channel** and then the TV channel you want your TV to turn to on a selected time and day
6. Select **Day** and then a day of the week or select **Daily**.
7. Select **Time** and enter the time with the digit buttons or with the cursor up/down.
8. Press the **OK** button to activate.
9. Press the cursor left to return to the Features menu or press the **MENU** button to switch off the menu.

**Note:** From now on, **every week**, your TV will automatically turn to the selected channel, on the selected day, at the selected time, until the On timer function is turned off again.

**Note:** only one On timer can be set.

TV menu	Features	Demo
	.....	Pixel Plus
	Set/Change PIN	Settings assistant
	On timer	Active Control
	<b>Demo</b>	
Info		

### Demo

This allows you to get an idea of the features that are part of the television.

1. Select **Demo**.
2. Press the cursor right.
3. Select a desired demo.
4. Press the **OK** button to start the demo.
  - ▷ The selected demo is played once.
5. Press the red color button to stop the demo and to return to the demo menu.
6. Press the red color button to exit the demo menu.

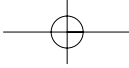

## How to search for and store TV channels

**Tip:** you will need this chapter only if you want to change the installation settings.

Television	TV menu Channel list
Multimedia	

TV menu	Installation
TV settings	Language
Features	Channels
Installation	Preferences
	Connections
	Clock
	Reset AV settings
	Software upgrade
Info	

### Installation menu

This menu will adjust settings related to the installation of the TV channels.

1. Press the **MENU** button on the remote control.
  - ▷ The main menu appears.
2. Select **TV menu** and press the cursor right.
  - ▷ The TV Menu is moved to the left.
3. Select **Installation** and press the cursor right.
  - ▷ The Installation menu is moved to the left panel.
4. Use the cursor up/down to select the Installation menu items.
5. Press the cursor right to enter the selected Installation menu item.
6. Use the cursor button to make a selection.
7. Press the **OK** button to activate or to confirm.
8. Press the cursor left to return to the Installation menu or press the **MENU** button to switch off the menu.

TV menu	
Installation	Language
Language	English
Channels	Français
Preferences	Español
Connections	Português
.....	
Info	

### Select your language

This allows you to select your menu language out of the list of the available languages.

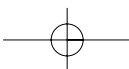

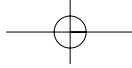

## How to search for and store TV channels (continued)

TV menu/Installation	
Channels	Autoprogram
Autoprogram	
Installation updat..	Start now
Weak channel ins..	
Installation mode	
Uninstall channels	
Info	

TV menu/Installation	
Installation mode	
Antenna	Please select your
Cable	installation mode.
● Previous ● Next ● ●	

### Store TV channels

After language is set correctly, you can now search for and store the TV channels.

1. Select **Channels** and press the cursor right.
2. Select **Autoprogram**.
3. Press the cursor right.
4. Press the **OK** button.
5. Select **Cable** or **Antenna** in the Installation mode.
  - ▷ When **Antenna** is selected, the TV will detect antenna signals and will search for antenna TV (NTSC and ATSC) channels available in your local area.
  - ▷ When **Cable** is selected, the TV will detect cable company supplied signals and will search for cable TV (NTSC, ATSC, QAM modulated) channels available in your area.

**Note:** Make sure that registration with your cable TV provider and connection of equipment are completed.

6. Press the green corresponding color button on the remote control for "**Next**".

**Note:** All channels must be unlocked in order to autoprogram. If requested, enter your PIN code to unlock all channels. See Adjust Feature menu settings, p. 28.

7. Press the green corresponding color button on the remote control for "**Start**" to start autoprogramming.
  - ▷ The menu screen disappears and the progress of autoprogramming is displayed. The progress bar indicates the number of analog and digital TV channels found.
  - ▷ When Autoprogramming is complete, a message appears confirming the completion and the TV switches to the first installed TV channel.
8. Press the red color button to finish.

### Notes:

- When you have locked TV channels while initiating autoprogram, a message appears asking to enter your PIN code in order to complete autoprogramming.
- When interrupted, the updated channel information is retained as well as the not yet updated old channel information.
- Background autoprogramming occurs only when the TV is turned on.
- Channel information of an ATSC channel is updated only for the ATSC channel currently tuned.
- Once you have searched for as well the available Antenna as well as the Cable TV channels, they are stored in the memory.

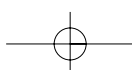
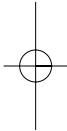
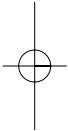

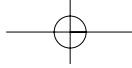

## How to search for and store TV channels (continued)

### Channel tuning

**Important:** After the installation of the TV channels has been done, always make a selection in the Installation menu, Installation mode between Antenna or Cable whether you want to watch Antenna TV channels or Cable TV channels.

**Note:** If you make use of a signal splitter do not forget to put the switch in the corresponding position.

Available channels:

- Cable (analog NTSC or digital QAM): max. from 1 to 135
- Terrestrial (analog NTSC or digital ATSC): max. from 2 to 69

If a tuned channel is not yet in the master channel map, the TV will attempt to tune the channel and it will be added to the map.

If the channel is not acquired, a message will appear that the channel is not available.

When you tune an audio-only digital subchannel, a display appears with the message **Audio only**.

### Notes:

#### - Subchannel selections

The new standards employed with digital broadcasting make it possible to receive multiple program channels under a single major channel number which can be selected by pressing the digit channel number entry.

#### - Digital Channel selection delay

Due to the tuning complexity of subchannel digital programming, the time to select and view a digital channel may take slightly longer than what the viewer is normally accustomed to (as compared to analog channel programs). Digital channel broadcasts contain program and system data information that must be processed before the channel selection can be displayed.

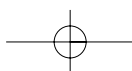

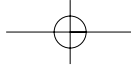

## How to search for and store TV channels (continued)

TV menu	
Installation	Channels
Language	Autoprogram
<b>Channels</b>	<b>Installation updat..</b>
Preferences	Weak channel ins..
Connections	Installation mode
Clock	Uninstall channels
Reset AV settings	
Software upgrade	
Info	

### Installation update

This allows you to automatically tune to and update all available digital channels.

#### Notes:

- this will not reinstall uninstalled channels;
- new channels found will not be added to any favorite list;
- already installed channels will not be renumbered.

TV menu	
Installation	Channels
Language	Autoprogram
<b>Channels</b>	<b>Installation updat..</b>
Preferences	<b>Weak channel ins..</b>
Connections	Installation mode
Clock	Uninstall channels
Reset AV settings	
Software upgrade	
Info	

### Weak channel installation

This allows you to manually tune weak ATSC channels in order to adjust the antenna and thus optimize signal quality for that channel.

This is only available for TV channels installed via an antenna connection (see p. 4).

1. Select a channel in the displayed list of TV channels (in the antenna mode).
2. The signal strength is displayed and updated continuously as you rotate the antenna.

TV menu	
Installation	Channels
Language	Autoprogram
<b>Channels</b>	<b>Installation updat..</b>
Preferences	Weak channel ins..
Connections	<b>Installation mode</b>
Clock	Uninstall channels
Reset AV settings	
Software upgrade	
Info	

### Installation mode

This allows you to select the already stored terrestrial or cable TV channels. Choose for Antenna or Cable whether these signals are present.

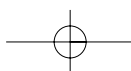

## How to search for and store TV channels (continued)

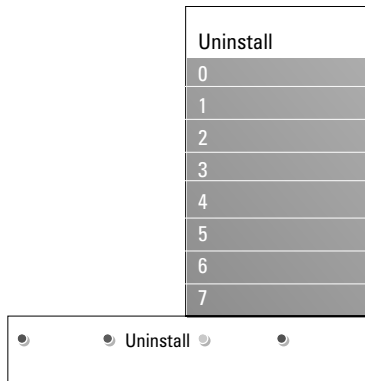

### Uninstall

This allows you to uninstall a stored channel so that it is no longer possible to tune to. This also allows you to reinstall an earlier uninstalled channel.

1. Select the channel you want to uninstall.
2. Press the green color button to uninstall the selected channel.
  - ▷ The uninstalled channel is indicated in the list by an icon in front of the uninstalled channel.
3. Press the green color button again to reinstall the uninstalled channel.

**Note:** uninstalled channels are not reinstalled during an installation update.

## Set your preferences

TV menu	
Installation	Preferences
Language	Location
Channels	OSD
Preferences	Show emerg. alerts
Connections	Downl. rating table
Clock	
Reset AV settings	
Software upgrade	
Info	

This menu contains items that can set or adjust various special TV functions and that will typically be accessed only occasionally.

### Select your location

This allows you to select the location of your TV.

If you choose for **Shop** it will result in fixed settings of picture and sound.

The location **Home** will give full flexibility to change any predefined settings for picture and sound.

### Select the On Screen Display (OSD)

This allows you to select the display of the volume bar.

1. Select **OSD**.
2. Press the cursor right to select **Minimum** or **Normal**.  
**Normal** to activate the temporarily display of the volume bar.

## Set your preferences (continued)

TV menu	
Installation	Preferences
Language	Location
Channels	OSD
<b>Preferences</b>	Show emerg. alerts
Connections	Downl. rating table
Clock	
Reset AV settings	
Software upgrade	
Info	

### Show emergency alerts (EAS)

This allows you to select the alert priority level of the information disseminated by the cable operator. The standard SCTE18 defines an Emergency Alert signalling method for use by cable TV systems to signal emergencies to digital devices such as digital Cable boxes, digital TVs and digital VCRs. The Emergency alert signalling scheme defined in the standard allows a cable operator to disseminate emergency alert information related to state and local-level emergencies and warnings in a cost-effective and efficient way, while minimizing disruption of programming. An Emergency alert message will have one of the following priorities: Low, Medium, High or Maximum. The Emergency alert message with priority High or Maximum will always be presented. Low or Medium will be present or ignored depending on the selected setting.

**Important:** When the TV clock is undefined (See installation menu, Clock, p. 37), the Emergency Alerts will be ignored.

The Emergency Alert message display will contain following information:

- The Emergency Alert text
- The start time + date
- The end time + date.

1. Select **Show Emergency Alerts** in the Menu preferences menu.
2. Press the cursor right and select one of the Emergency alerts options:
  - **Always**, when you always want the Emergency alert messages to be displayed when available;
  - **Skip low priority**, when you want the messages with low level to be ignored;
  - **Skip low/medium priority**, when you only want the messages with high priority to be displayed.

#### Notes:

- Emergency Alert Signalling is not possible:
  - when content browsing;
  - with analog video sources.
- You always have the possibility to remove the message from the screen.
- The message display will overlap whatever menu element or other message is on the screen.

### Downloaded rating table

This allows you to add region ratings lock options next to your current ones.

**Caution:** Before activating, please ensure regional ratings are broadcasted.

Settings/Setup/Preferences	
Preferences	Downloaded ratin...
Caption service	On
Dig. caption serv.	Off
Dig. caption opt.	
<b>Downloaded rat....</b>	
Info	

## Select your connections

TV menu	
Installation	Connections
Language	AV1
Channels	AV2
Preferences	AV3
<b>Connections</b>	HDMI 1
Clock	HDMI 2
Reset AV settings	Side
Software upgrade	DIGITAL AUDIO IN
Info	

This allows you to identify the type of accessory device you have connected to each particular input and output.

1. Select **Connections**.
2. Press the cursor right to enter the list of types of external inputs.
3. Select the appropriate input with the cursor up/down.
  - ▷ When you select **AV1, AV2, AV3, HDMI 1, HDMI 2, Side** or **DIGITAL AUDIO IN** a list appears allowing you to identify which type of accessory device is attached to this input.
4. Press the cursor right again to enter the list of types of devices connected to the selected input.
5. Select the accessory device with the cursor up/down.

### Digital Audio In

If an accessory device has a digital audio output, you can connect this with a single cable to the TV's **DIGITAL AUDIO IN** jack.

In the Connections menu, assign the **DIGITAL AUDIO IN** to the corresponding external input to which your accessory device is connected.

In addition to accepting audio input via Digital Audio In, the TV can output encoded Dolby Digital audio via the **DIGITAL AUDIO OUT** connector to an external amplifier or receiver.

If your amplifier or receiver has a matching connector for Digital Audio In, you can connect it with a single cable to the TV's **DIGITAL AUDIO OUT**.

See To make Video and Audio connections, Digital Surround receiver, p. 55.

## Set your clock

TV menu	
Installation	Clock
Language	Auto clock mode
Channels	Auto clock channel
Preferences	Time
Connections	Day
Clock	Time zone
Reset AV settings	Daylight saving
Software upgrade	
Info	

This allows you to set the time and day.

**Note:** Adjusting the clock is necessary for the correct working of Lock after (See Adjust feature menu settings, p. 25) features.

### Auto clock mode

1. Select **Clock** in the Installation menu.
2. Press the cursor right to select the **Auto clock mode**.
3. Press the cursor right to instruct the TV to get the time automatically or manually.

**Note:** Most of the TV channels are not transmitting clock information. There are few cable channels but they are at the end of the channel ring. There is no clock transmission in antenna channels. In such cases either clock extraction is taking a long time or there is no clock.

**Auto clock channel** (only available when Auto clock mode is set to Automatic)

With the cursor buttons, select the channel number on which time can be found by the TV. Typically time can be found on PBS (Public Broadcasting System) as well as some other channels.

**Time - Day** (only available when Auto clock mode is set to Manual)

With the cursor buttons, select and enter the correct time and day.

If **Auto clock mode Manual** has been selected, and no clock search has been done, the system will keep the entered time and day.

**Time zone** (only available when Auto clock mode is set to Automatic)

This function allows you to select your local time zone. Broadcasted time information will correct the clock display for your local time.

1. Select **Time zone** with the cursor down.
2. Press the cursor right to select your local time zone.

**Daylight saving** (only available when Auto clock mode is set to Automatic)

Daylight saving time is automatically set by specially broadcasted signals. This menu item allows you to disable the automatic setting of daylight saving time. This is useful if you live in an area or state where daylight saving is not applied, but you receive channels from other areas where daylight saving signals are broadcasted.

1. Select **Daylight saving** with the cursor down.
2. Press the cursor right to select **Automatic** for automatic clock correction for daylight saving time, based on specially broadcasted signals.
3. Select **Off** to disable automatic clock correction based on the specially broadcasted signals.

**Note:** Changes in Clock settings are only activated after switching to standby.

## Reset AV settings

TV menu	
Installation	Reset AV settings
Language	
Channels	Reset
Preferences	
Connections	
Clock	
<b>Reset AV settings</b>	
Software upgrade	
Info	

This allows you to reset most of the picture and sound settings to their predefined factory states.

1. Select **Reset AV settings** with the cursor down.
2. Press the cursor right.
3. Press the **OK** button to erase settings and reset them to their default values.

## How to upgrade the TV software

TV menu	
Installation	Software upgrade
Language	Current softw. info
Channels	Local upgrades
Preferences	
Connections	
Clock	
Reset AV settings	
<b>Software upgrade</b>	
Info	

This menu allows you to upgrade your TV software using a USB device.

The USB device must be filled with the appropriate upgrade image (and structure) which can be found on the [www.philips.com/support](http://www.philips.com/support) website. How to upload a new software version on your portable memory device, see Annex 1, p. 59.

## Create your favorite list

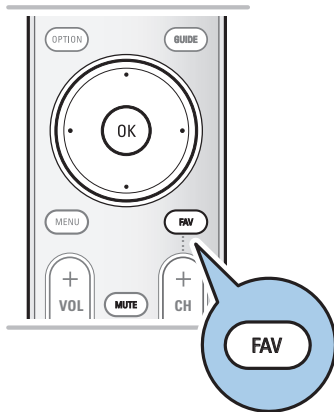

This allows you to select up to four favorite channels lists with your preferred TV channels and radio stations. For example, each member of your family can create his/her own favorite list. In addition to the favorite channel lists you may also select a list with only digital TV channels or a list with only the radio channels or a list with only the analog channels.

**Note:** when this key is pressed the first time after you have finished the installation, it will bring up the full channel list. In other situations it will bring up the last selected channel list.

### To select a channel from the displayed favorite list

1. Press the **FAV** button (or the **OK** button).
  - The last selected channel list appears.
2. Use the cursor up/down to select a channel.
3. Press the **OK** button to display the selected channel.

### To select another favorite channel list

1. Press the **FAV** button (or the **OK** button).
  - The last selected channel list appears.
2. Press the red color button to bring up the list of possible favorite channel lists.
3. Use the cursor up/down to select a list.
4. Press the **OK** button.
5. Press the **FAV** button again to exit.

### To create a favorite list or to modify the list

1. Press the **FAV** button (or the **OK** button).
  - The last selected channel list appears.
2. Press the red color button.
  - A list with all possible favorite channel lists appears.
3. Use the cursor up/down to select a Favorites (1 to 4) channel list.
4. Press the **OK** button.
5. Press the green color button to enter the Edit mode.
  - The selected Favorite list will bring up a full channel list.
6. Use the cursor up/down to select a channel.
7. Press the **OK** button to check or uncheck the highlighted channel and to add it to or remove it from your selected favorite list.
- 8a.
  - Press the green color button again to leave the Edit mode.
    - The modified favorite channel list appears.
  - Press the **FAV** button again to exit.
    - With the **-P+** button you will be able to browse through the TV channels of the selected list.
- 8b. Press the red color button to remove the channel list.

**Note:** with the digit buttons you can still select channels which are not marked as favorite.

All channels	
AV1	
AV2	
<b>HDMI</b>	
<b>A</b> 1 Analog channel 1	
2 Digital channel 1	
3 Digital channel 2	
<b>+</b> 4 Radio channel 1	
<b>≡</b> 5 Data channel 1	
<span style="color:red">●</span> Select list	<span style="color:green">●</span>
Tune to a channel by pressing OK. Use -CH+ for page up/down.	

All channels	
<b>All</b>	
TV channels	
Radio channels	
<b>A</b> Analog	
Favorites 1	
Favorites 2	
Favorites 3	
Favorites 4	
<span style="color:red">●</span> Select list	<span style="color:green">●</span>
Use cursor up/down to select and OK to confirm.	

Favorites 1	
<input checked="" type="checkbox"/> AV1	
<input checked="" type="checkbox"/> AV2	
<b>HDMI</b>	
<b>A</b> 1 Analog channel 1	
<input checked="" type="checkbox"/> 2 Digital channel 1	
3 Digital channel 2	
<b>+</b> 4 Radio channel 1	
<b>≡</b> 5 Data channel 1	
<span style="color:red">●</span> Exit	<span style="color:green">●</span> Back
Press the OK button to check / uncheck.	

## EPG (Electronic Program Guide) (only with Digital TV broadcasting)

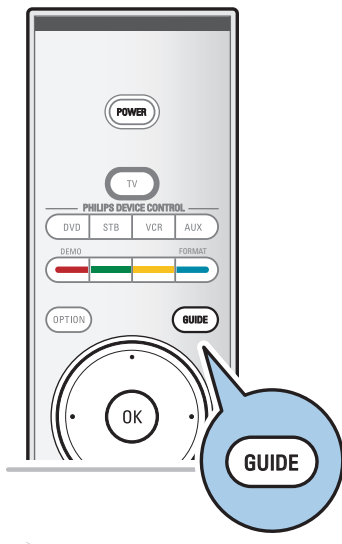

The Electronic Program Guide shows you detailed information about the current program and also about the next program (if this information is available).

1. Press the **GUIDE** button.
  - ▷ The EPG screen appears. Dependent on conditions it may take some time to acquire EPG data.
  - ▷ The EPG screen updates automatically if the EPG data is acquired successfully. If not, the EPG screen remains blank.
  - ▷ Information about the selected program appears.
  - Use the colored buttons to activate the available EPG features displayed at the bottom of the screen.
2. To quit the Program Guide page, press the **GUIDE** button again.

## Multimedia Browser

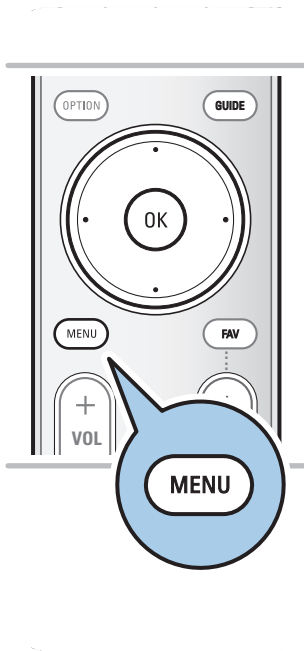

The Multimedia browser lets you display pictures or movies or play audio files stored on a USB device. The Multimedia browser application is invoked from the main menu.

1. Press the **MENU** button on the remote control.
2. Select **Multimedia** and press the cursor right.
3. Select the USB device inserted into the USB connector at the side of the TV.
4. Press the cursor right and select a content type.

- Following file formats can be reproduced:

for pictures: JPEG

for audio: MP3, MP3 Pro, LPCM

for video: MPEG1, MPEG2

- Only FAT/DOS-formatted memory devices are supported.
- Philips can not be held responsible if your USB device is not supported.

### To view content from a USB device

**Tip:** if your USB device does not fit into the USB connector at the side, use an USB extend cable to connect the USB device to the USB port. Ask your dealer for more information.

### To insert a USB device

**Note:** USB devices are not supplied with this TV.

- o Insert a USB device to the USB connector at the side of the TV.  
When a USB device is inserted, the Multimedia browser menu is displayed automatically. See further.

### To remove the USB device

1. Press the **MENU** button on the remote control to turn off the main menu.
2. Remove the USB device.

Television	TV menu Channel list
Multimedia	USB device 1



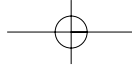

## Multimedia Browser (Continued)

### Function buttons at the bottom of the screen

Details	to display a description of the selected file or directory
Transitions	to select if you like to apply a transition during a slide show
Slide time	to select the duration a picture will be displayed in a slide show
Rotate	to rotate a picture
Repeat one/all	to repeat the playback of a music file
Shuffle	to shuffle music collections in a random way
Zoom	to select one of the zoom magnifications (x1, x2, x4) with the cursor up/down. Additionally you can shift the selected zoom window over the screen with the cursor buttons
Full/small screen	to toggle between a full or a small screen.

**Note:** to rotate a picture or to select one of the zoom magnifications, first stop the slide show with the **OK** button or the blue color button.

### Multimedia function buttons on the remote control

- ◀◀ to fast rewind displaying content
- to stop playing content
- ▶ - to play a single file, start a slide show, playback of a folder or other collection  
- to pause playing content
- ▶▶ to fast forward displaying content

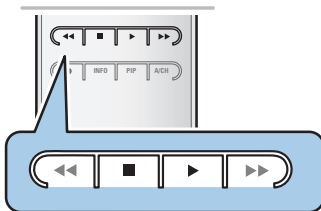













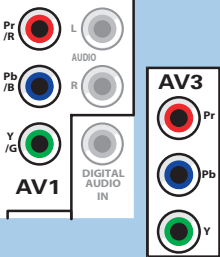

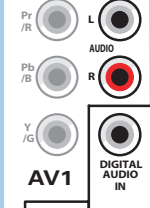
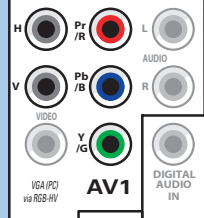
## To make video and audio connections

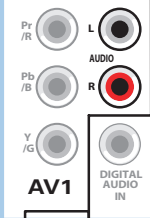
**Tips:**

- use the inputs that are available on your equipment that provide the best video or audio performance, as below;
- if you experience a discolored line on the left or right side of the set, adjust the picture position to the centre of the screen with the cursor buttons.

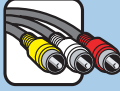
**Note:**

- your TV comes with all types of connectors with the exception of the DVI connector but some of your equipment may be equipped with this type. In this case you'll need a DVI to HDMI adapter or a HDMI to DVI cable and separate audio cables, all available at your local dealer.
- be sure to connect the DVI output connector first, then connect to the HDMI input on your TV.

	Connector cable	Audio connection required
 <b>HDMI</b>	HDMI (High-definition Multimedia Interface) 	No
	Component video (480p/720p/480i/1080i)  - for analog audio (AV1)  - for digital audio (AV1 or AV3)	 AUDIO L / R DIGITAL AUDIO IN
	RGB H/V 	 AUDIO L / R
 <b>S-VIDEO</b>	S-Video 	AUDIO L / R :  AV1 AV2 SIDE
 <b>VIDEO</b>	Video 	AUDIO L / R :  AV1 AV2 SIDE
 <b>75 Ω</b>	RF/Coaxial 	No

**Warnings:** in case you notice scrolling images, wrong colors or no color, no picture, or even combinations of these on your screen, verify if the connections are done in the correct way and if the resolution and the signal standard of the connected equipment are set in the right way. See the handbook for your equipment.

## To make video and audio connections (Continued)

### Notes:

- Cables are often color-coded to connectors. Connect red to red, white to white....
- Component video (YPbPr) connection is necessary to view video sources, for example digital broadcastings coming from a settop box, in 1080i, 720p, 480i or 480p;
- The labels for the component video sockets may differ depending on the DVD player or the device connected. Although the abbreviations may vary, the letters B and R stand for the blue and red component signals, respectively, and Y indicates the luminance signal. Refer to the DVD player's or devices instructions for use for definitions and connection details;
- This television is designed to accept high definition signal standards 480p, 720p and 1080i as specified by the Electronic Industries Association standard EIA770.3.  
Digital devices from different manufacturers have the possibility of differing output standards which may cause difficulties for the television to properly display.

## Side panel overview

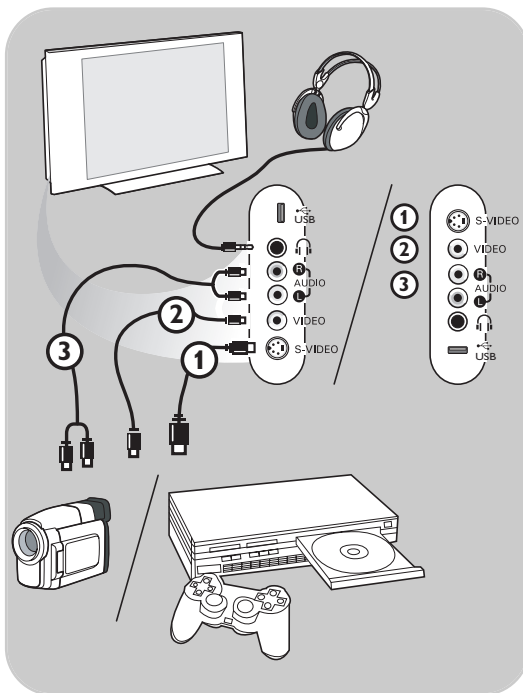

### Camera, Camcorder, Game

1. Connect your camera, camcorder or game as shown.
2. Connect to **VIDEO ②** and **AUDIO L ③** for mono equipment. For stereo equipment also connect **AUDIO R ③**.  
S-VHS quality with an S-VHS camcorder is obtained by connecting the S-VHS cables with the **S-VIDEO** input ① and **AUDIO** inputs ③.

**Warning:** do not connect cable ① and ② at the same time. This may cause picture distortion !

### Headphone

1. Insert the plug into the headphone socket as shown.
2. The headphone impedance must be between 8 and 4000 Ohm. The headphone socket has a 3.5 mm jack.  
In the Sound menu select **Headphone volume** to adjust the headphone volume.

**Tip:** Press  on the remote control to switch off the internal loudspeakers of the TV.

### USB

See Multimedia browser, p. 41.

### Rear panel overview

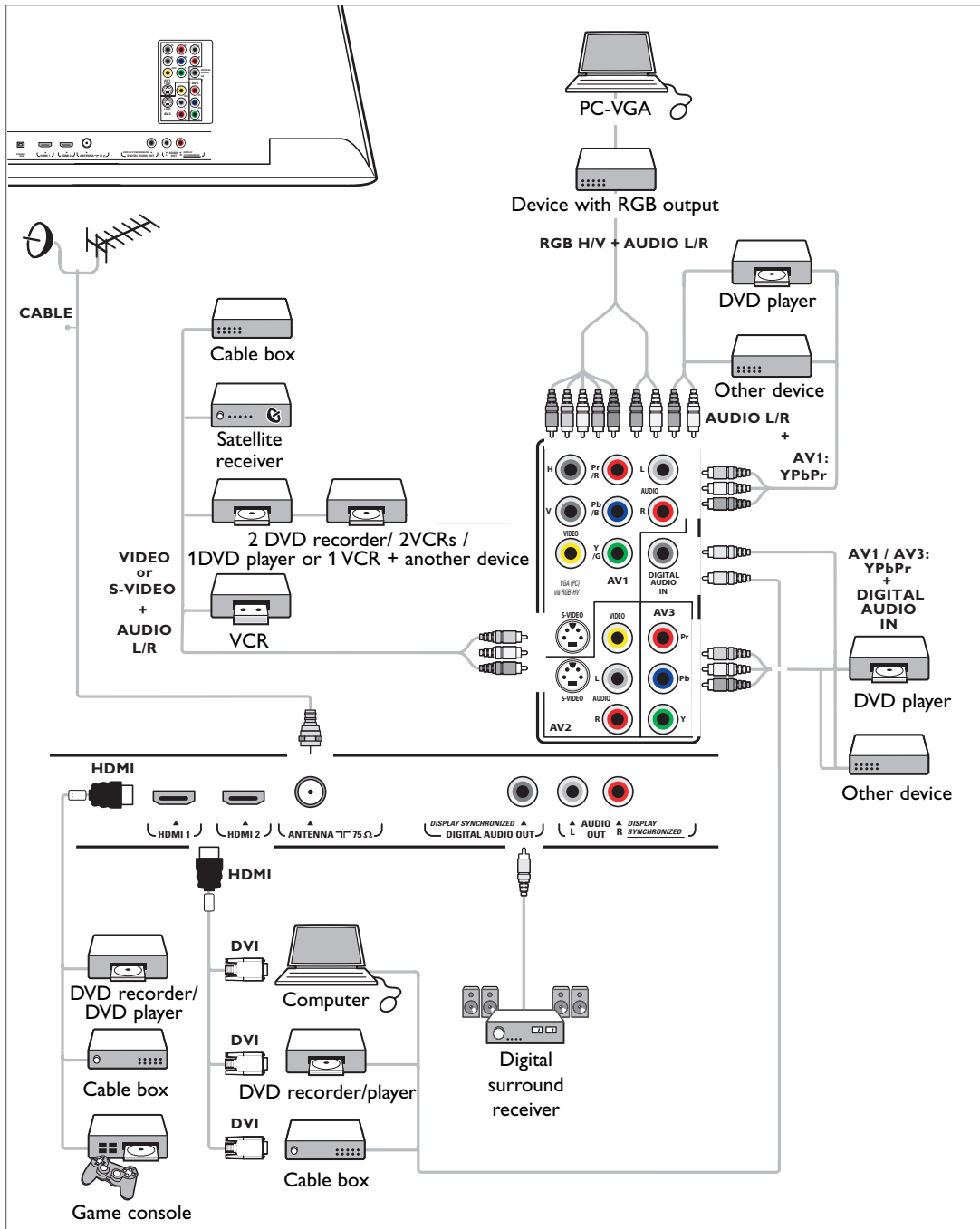

## Connect a VCR or DVD recorder

**Warning:** do not place your recorder too close to the screen as some recorders may be susceptible for signals from the display. Keep a minimum distance of 0,5 m from the screen.

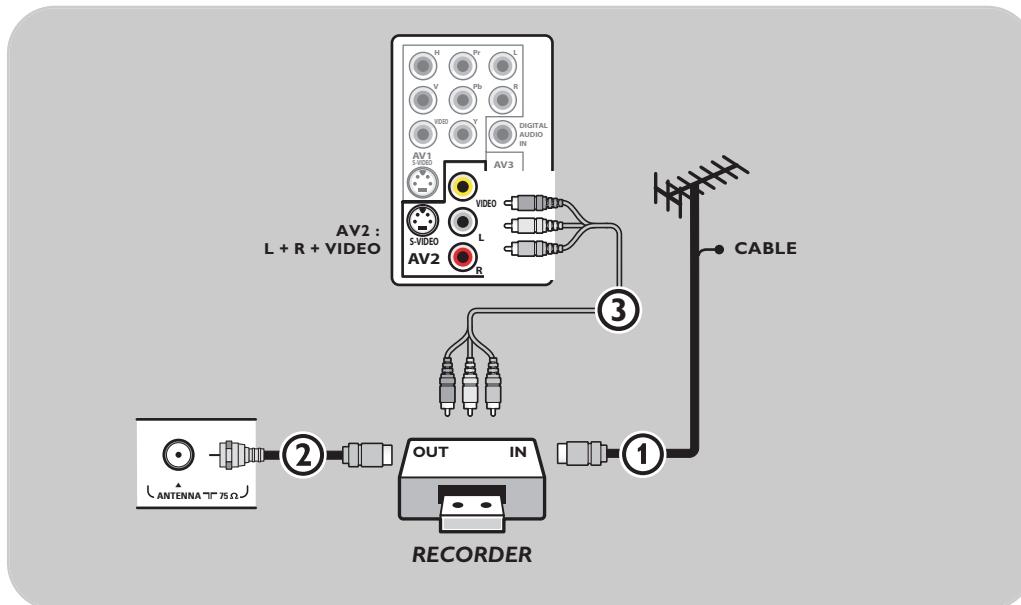

English  
User Manual

1. Connect the RF Antenna or Cable TV cable (eventually via an optional two-way signal splitter and/or Cable TV converter box) ① to the **RF IN** socket of your recorder.
2. Connect another RF cable ② from the output **OUT** of your recorder to the TV's **CABLE/ANTENNA 75 Ω** jack.
3. Better playback quality can be obtained if you also connect the Video, Audio Left and Right (only for stereo devices) AV cables ③ to the **VIDEO, AUDIO L** and **R** input jacks of **AV2**.
4. Select the equipment you have connected in the **Installation** menu, **Connections**, p. 36 and link them to the **AV** connectors you have connected your equipment to.

### Notes:

- cables are often color-coded to connectors. Connect red to red, white to white....
- if your recorder has an S-VHS video jack:  
For improved picture quality, connect an S-video cable with the **S-VIDEO** input and connect the audio cables to the **AUDIO L** and **R** input jacks of **AV2**.  
When using the **S-VIDEO** connector do not connect any device to the **AV2 VIDEO** jack.
- in case of mono equipment, only the left loudspeaker reproduces sound.  
Use a mono to stereo adapter (not supplied) for sound reproduction via all internal loudspeakers.

## Connect a recorder and other A/V devices

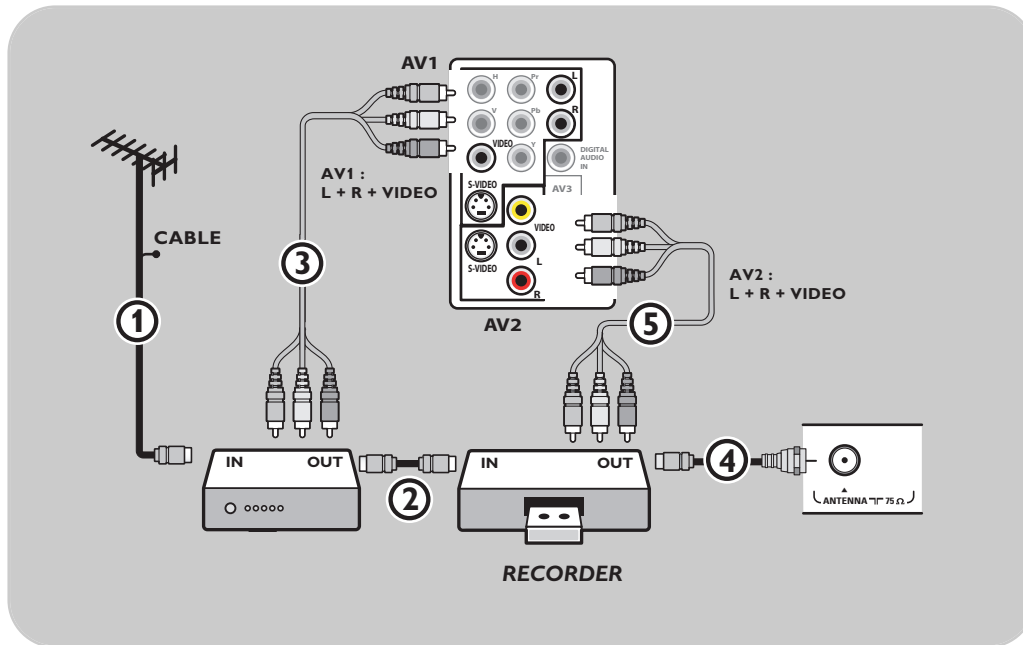

1. Connect the RF antenna cable ① of the **RF IN** socket of your other AV device.
2. Connect the RF output of the AV device to the RF input of the recorder ②.
3. Connect another RF cable ④ from the output **OUT** of your recorder to the TV's input **CABLE/ANTENNA 75 Ω** jack.
4. To obtain better quality, also connect the Video, Audio left and Audio right cables of both devices to **AV1** or **AV2 (VIDEO, AUDIO L and R,)** ③ and ⑤.
5. Select the equipment you have connected in the **Installation** menu, **Connections**, p. 36 and link them to the **AV** connectors you have connected your equipment to.

### Notes:

- cables are often color-coded to connectors. Connect red to red, white to white....
- if your recorder has an S-VHS video jack:  
For improved picture quality, connect an S-video cable with the **S-VIDEO** input of **AV1** or **AV2** and connect the audio cables to the **AUDIO L** and **R** input jacks of **AV1** or **AV2**.  
When using the **S-VIDEO** connector do not connect any device to the **AV1** or **AV2 VIDEO** jack;
- in case of mono equipment, only the left loudspeaker reproduces sound.  
Use a mono to stereo adapter (not supplied) for sound reproduction via all internal loudspeakers.

## Connect a recorder and Cable box with RF output

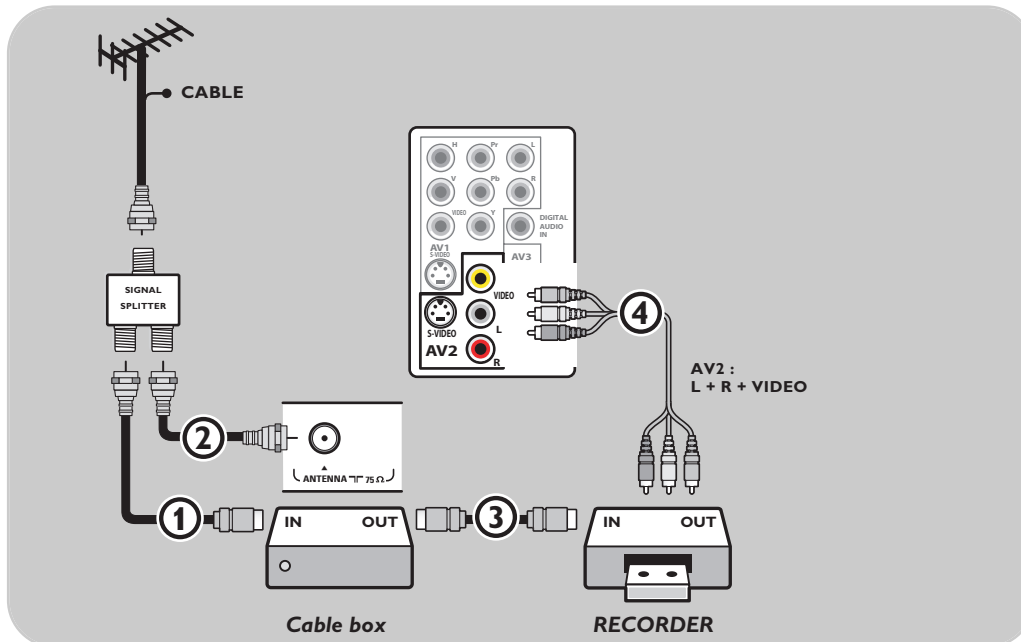

1. Use an optional signal splitter.
2. Connect one of the cable TV signal splitter outputs (1) to the cable box's **IN** jack.
3. Connect the other cable TV signal splitter output (2) to the **CABLE/ANTENNA 75 Ω** plug on the bottom of the TV.
4. Connect the cable box's **OUT** jack (3) to the recorder's **RF IN** socket.
5. Connect the Video, Audio Left and Right (only for stereo sound) recorder AV cables (4) to the **VIDEO**, **AUDIO L** and **R** input **AV2** jacks on the TV.
6. Select the equipment you have connected in the **Installation** menu, **Connections**, p. 36 and link it to the **AV** connector you have connected your equipment to.

### Notes:

- cables are often color-coded to connectors. Connect red to red, white to white....
- if your recorder has an S-VHS video jack:  
For improved picture quality, connect an S-video cable with the **S-VIDEO** input of **AV2** and connect the audio cables to the **AUDIO L** and **R** input jacks of **AV2**.  
When using the **S-VIDEO** connector do not connect any device to the **AV2 VIDEO** jack;
- in case of mono equipment, only the left loudspeaker reproduces sound.  
Use a mono to stereo adapter (not supplied) for sound reproduction via all internal loudspeakers.

## Connect a satellite receiver or Cable box with A/V outputs

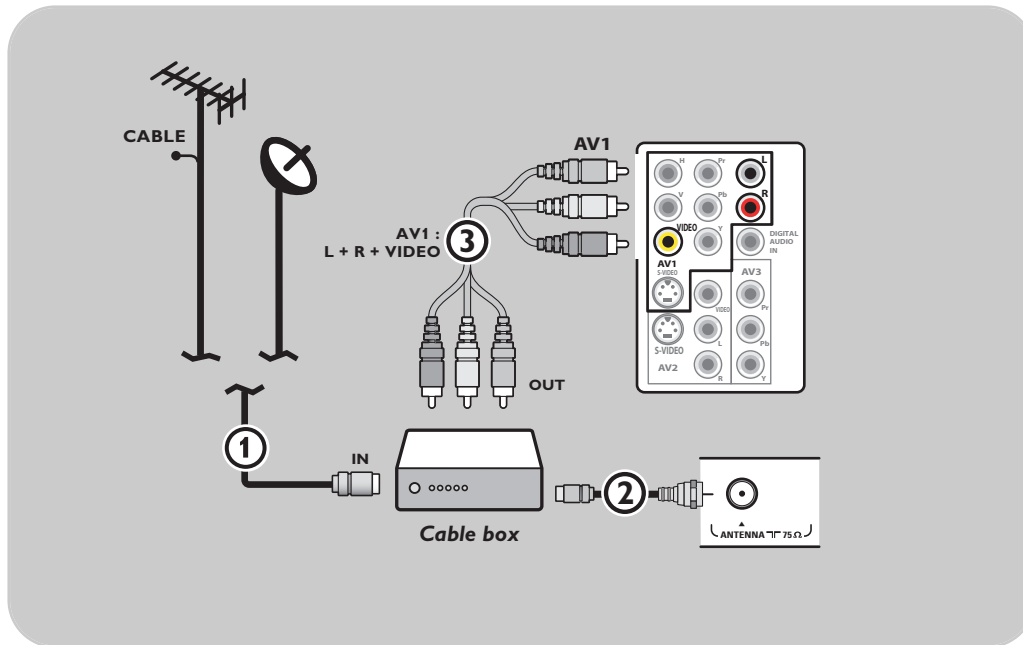

1. Connect the satellite antenna cable or the Cable TV cable ① to the satellite receiver's or cable box's **IN** jack.
2. Connect another RF cable ② from the output **OUT** of the satellite receiver or cable box to the TV's **CABLE/ANTENNA 75 Ω** jack.
3. Connect the Video, Audio left and right AV cables ③ to the **VIDEO**, **L** and **R** audio input jacks of **AV1**.
4. Select the equipment you have connected in the **Installation** menu, **Connections**, p. 36 and link it to the **AV** connector you have connected your equipment to.

### Notes:

- cables are often color-coded to connectors. Connect red to red, white to white....
- if your satellite receiver or cable box has an S-VHS video jack:  
For improved picture quality, connect an S-video cable with the **S-VIDEO** input of **AV1** and connect the audio cables to the **AUDIO L** and **R** input jacks of **AV1**.  
When using the **S-VIDEO** connector do not connect any device to the **AV1 VIDEO** jack;
- in case of mono equipment, only the left loudspeaker reproduces sound.  
Use a mono to stereo adapter (not supplied) for sound reproduction via all internal loudspeakers.

## Connect a recorder and satellite receiver or Cable box with AV outputs

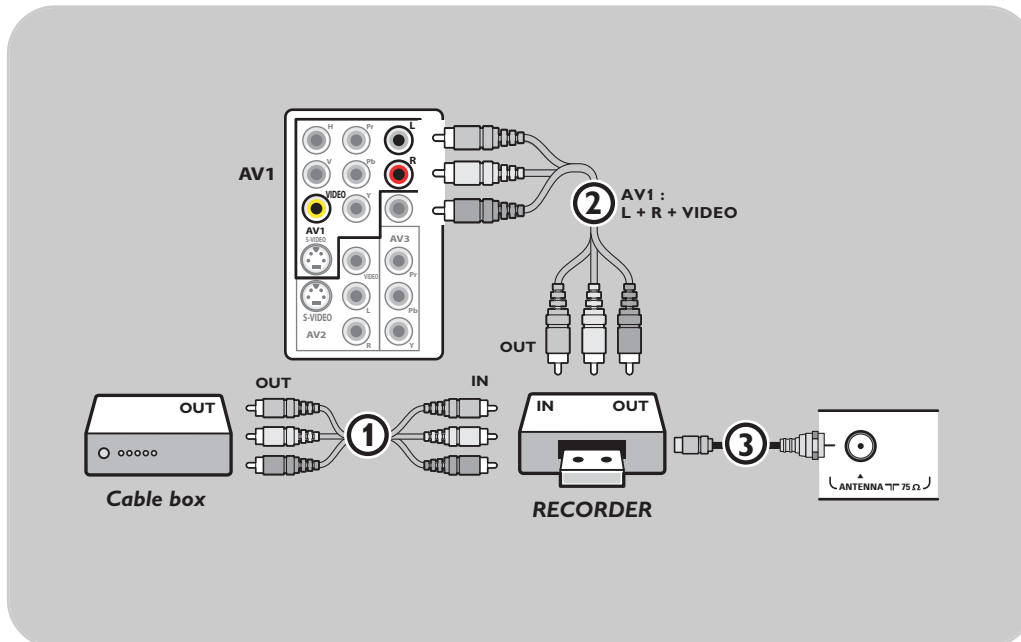

English  
User Manual

1. Connect the satellite antenna cable or the Cable TV cable to the satellite receiver's or cable box's **IN** jack.
2. Connect the AV cables ① to the satellite receiver's or cable box's **AV OUT** jacks and to the recorder's **AV IN** jacks.
3. Connect the Video, Audio Left and Right (only for stereo sound) recorder AV cables ② to the **VIDEO, AUDIO L** and **R** input **AV1** jacks on the TV.
4. Connect another RF cable ③ from the output out of your recorder to the TV's input **CABLE/ANTENNA 75 Ω** jack.
5. Select the equipment you have connected in the **Installation** menu, **Connections**, p. 36 and link it to the **AV** connector you have connected your equipment to.

### Notes:

- cables are often color-coded to connectors. Connect red to red, white to white....
- if your recorder has an S-VHS video jack:  
For improved picture quality, connect an S-video cable with the **S-VIDEO** input of **AV1** and connect the audio cables to the **AUDIO L** and **R** input jacks of **AV1**.  
When using the **S-VIDEO** connector do not connect any device to the **AV1 VIDEO** jack;
- in case of mono equipment, only the left loudspeaker reproduces sound.  
Use a mono to stereo adapter (not supplied) for sound reproduction via all internal loudspeakers.

## Connect a DVD Player or other accessory digital source devices

**Note:** This TV is capable of displaying 1080i, 720p and 480p DTV signals when connected to a DTV tuner cable box. Select the output of the cable box to either 1080i, 720p or 480p. A DTV signal must be available in your area.

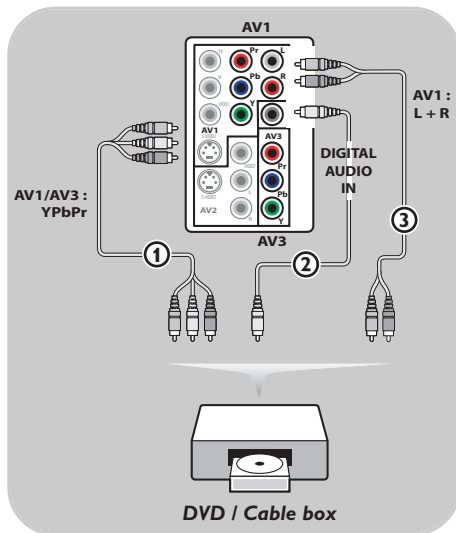

### Devices with Component Video Output Connectors (YPbPr)

1. Connect the three separate component video cables ① to the device having component video outputs (YPbPr), such as cable boxes, DVD-players, laser-disc players, videogame players, satellite receivers or other equipment, and to the **Y**, **Pb** and **Pr** jacks of **AV1** or **AV3** on the TV.
2. In case of devices with analog audio signals, connect to the **Y**, **Pb** and **Pr** jacks of **AV1**. In case of devices with digital audio signals, connect to the **Y**, **Pb** and **Pr** jacks of **AV1** or **AV3**.
3. In case of a device with digital audio, connect the audio cable ② to the **DIGITAL AUDIO OUT** of the device and to the **DIG. AUDIO IN** of the TV. In case of a device with analog audio, connect the audio cable to the device's **AUDIO L** and **R** ③ and to the **L** and **R** audio jacks of **AV1**.
4. Select the equipment you have connected in the **Installation** menu, **Connections**, p. 36 and link it to the **AV** connector you have connected to.

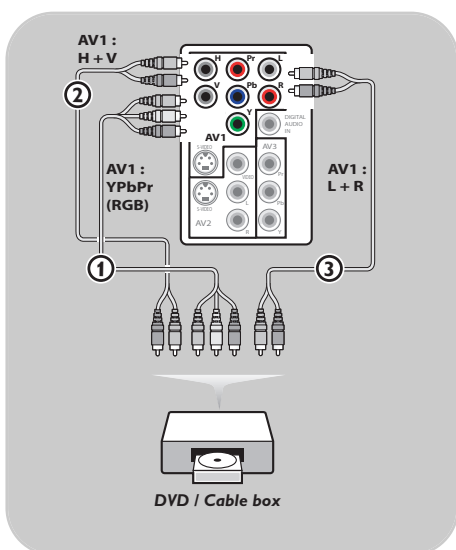

### Devices with RGB Output

1. Connect the device with RGB output with separate Horizontal and Vertical sync to the **Pr/R**, **Pb/B** and **Y/G** input ① jacks and to the **H** and **V** jacks of **AV1** ②.
2. Connect the audio cables to the **L** and **R AUDIO** jacks of **AV1** ③.
3. Select the equipment you have connected in the **Installation** menu, **Connections**, p. 36 and link it to **AV1**.

## Connect a DVD Player or other accessory digital source devices

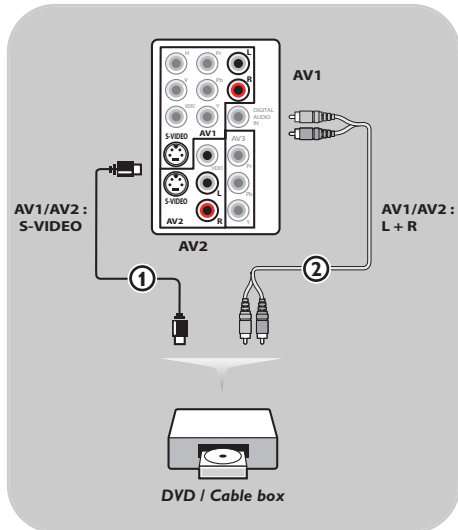

### Devices with an S-Video connector

1. Connect an S-Video cable to the **AV1** or **AV2 S-VIDEO** input ①.

**Tip:** When using the **S-VIDEO** connector do not connect any device to the **AV VIDEO** input that you are using.

2. Connect the audio cables to the device's **AUDIO L** and **R** jacks and to the **L** and **R** audio **AV1** or **AV2** jacks ② on the TV accordingly to where you connected the S-Video cable.
3. Select the equipment you have connected in the **Installation** menu, **Connections**, p. 36 and link it to the **AV** connector you have connected to.

## Connect a device to the HDMI (High Definition Multimedia interface) connector

### Notes:

- HDMI is the leading new standard for Digital video and audio interconnection. To the **HDMI** connector you can connect HDMI devices such as a Cable box or compatible DVD-R or DVD player with HDMI, or DVI-equipped devices like a computer.
- If necessary, you can adjust the picture position to the center of the screen with the cursor buttons.

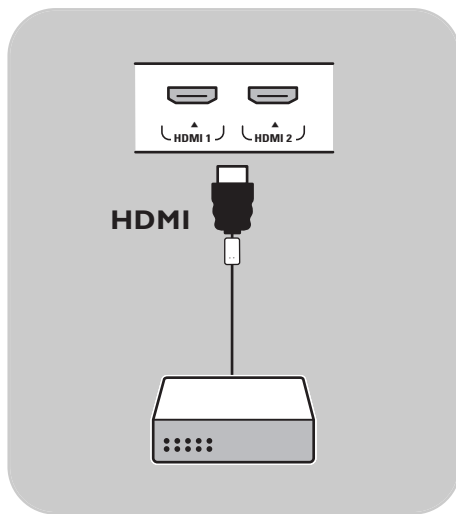

### Devices with a HDMI connector:

1. Connect your HDMI device with the **HDMI** connector.
2. Select the equipment you have connected in the **Installation** menu, **Connections**, p. 36 and link it to **HDMI 1** or **2**.

**Note:** in case of any problems, see Annex 4: Issues referring to connected equipment with a HDMI connector, p. 64.

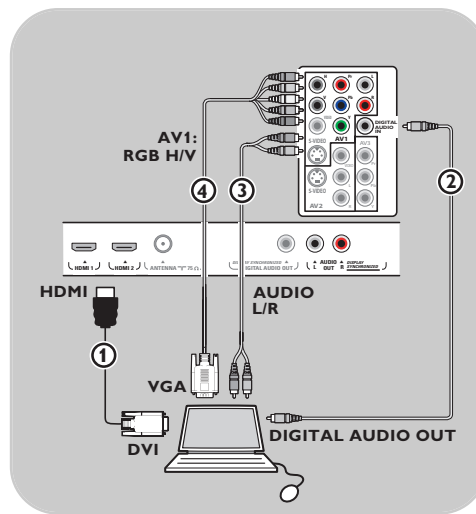

### PC equipped with a DVI connector:

1. Use a DVI to HDMI cable to connect to one of the **HDMI** connectors of your TV (1).
2. Connect the audio cable (2) to the PC's Digital Audio out jack and to the **DIGITAL AUDIO IN** jack on the TV.
3. In the **Installation** menu, **Connections**, p. 36, select the **HDMI 1** or **2** input, and link it to the computer (PC).
4. In the same menu, link the **DIGITAL AUDIO IN** to the corresponding **HDMI** input.

### PC equipped with a VGA connector:

1. Use a VGA to RGB H/V cable (4) to connect to the **RGB H/V** connectors of your TV.
2. Connect the audio cable (3) to the **AUDIO R** (right) and **L** (left) inputs of **AV1**.
3. Select the equipment you have connected in the **Installation** menu, **Connections**, p. 36 and link it to **AV1**.

## Connect a Digital Surround receiver

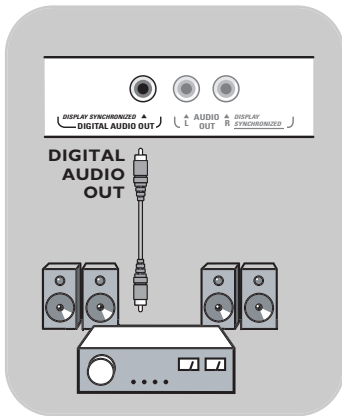

- Connect a MultiChannel Surround receiver to the **DIGITAL AUDIO OUT** connector at the bottom of the TV.

**Note:** Due to legal requirements, it is possible that with certain copy protected PCM audio qualities from a peripheral equipment connected to the **HDMI** input, the Digital audio output signal is muted.

English  
User Manual

## Record with your recorder

**Note:** to record digital programs to an analog recorder, the TV needs to be switched on and tuned to that digital programs.

### Record a TV program

You can record a TV program using your recorders tuner without affecting your TV.

- Select the channel number on your recorder.
- Set your recorder to record.  
See the handbook for your recorder.

**Note:** When recording analog programs, switching channel numbers on your TV does not disturb recording !

## Select connected equipment

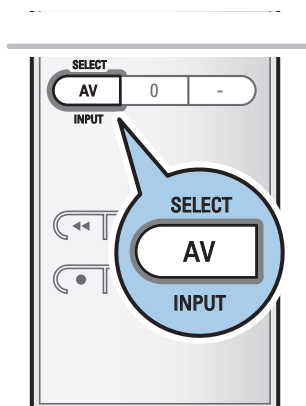

Before operating your connected equipment you have to make a selection in the **Installation, Connections** menu, p. 36.

- Press the **AV** button.
- Press the cursor up/down to select **AV1, AV2, AV3, HDMI 1, HDMI 2, Side** or **TV**, according to where you connected your devices.
- Press **OK**.

## Audio- and video equipment buttons

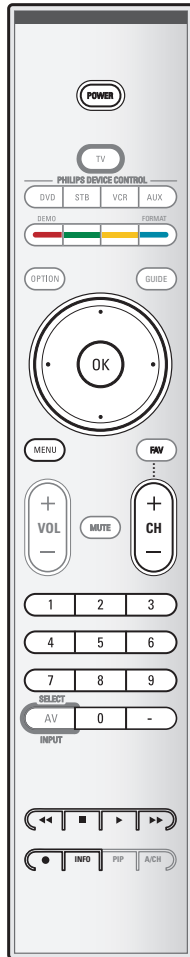

Most of the audio and video equipment from our range of products can be operated with the remote control of your TV. Press one of the buttons after you pressed one of the mode buttons (**DVD, STB, VCR, AUX**) according to the equipment you want to operate with this remote control. See Use of the Remote control, p. 6-8.

### POWER



### INFO

### MENU

### - CH +

### 0 to 9

cursor up/down

cursor left/right

### A/CH

to switch to standby

for record,

for rewind (**VCR, CD**);

search down (**DVD**)

for stop,

for play, for pause

for fast forward (**VCR, CD**);

search up (**DVD**)

to display information

to switch the menu on or off

for chapter, channel, track selection

digit entry,

to select the next or the previous

disc (**CD**)

to select the previous or following

track (**CD**)

to select a DVD title/chapter;

index (**AUX**)

**Normal mode:** if no action is being undertaken within 30 seconds, the remote control returns to TV mode.

**Expert mode:** in Expert mode the remote will stay in the selected mode even when the 30 seconds time-out is elapsed.

### To select between Normal and Expert mode

1. Select TV mode with the **TV** button.
2. Press the **OK** button simultaneously with the **MUTE** button for four seconds.
  - ▷ When the **POWER** button is On for one second, the Expert mode is selected and the remote control will remain in the mode selected.
3. Select the desired mode (**DVD, STB, VCR, AUX**)
4. To go back to the TV mode, select **TV** and repeat steps 1. to 3.

## Before Calling Service

Symptoms	Items to Verify and Actions to follow
<b>“Ghost” or double images</b>	<ul style="list-style-type: none"> <li>This may be caused by obstruction to the antenna due to high rise buildings or hills. Using a highly directional antenna may improve the picture.</li> </ul>
<b>No power</b>	<ul style="list-style-type: none"> <li>Verify that the TV's AC power cord is plugged into the mains socket.</li> <li>Unplug the television, wait for 60 seconds. Then re-insert plug into the mains socket and turn on the television again.</li> </ul>
<b>No picture</b>	<ul style="list-style-type: none"> <li>Verify antenna connections at the bottom of the TV to see if they are properly connected to the TV.</li> <li>Possible broadcast station trouble. Try another channel.</li> <li>Adjust the contrast and brightness settings. Try another auto picture setting.</li> <li>Verify the Closed Captions control. Some TEXT modes could block the screen.</li> <li>Verify if you selected the correct AV source.</li> </ul>
<b>No picture and power switched on</b>	<ul style="list-style-type: none"> <li>Your TV has a protective mode in case there is too much heat build-up. Verify the clearance around the vents of the device to be certain there are no blocking walls or cabinets which would limit the air flow.</li> </ul>
<b>Picture position adjustment</b>	<p>When displaying a High Definition signal from the YPbPr inputs or HDMI input, if necessary, you can adjust the picture position to the center of the screen with the cursor left/right or up/down buttons on the remote control. This may be needed due to slight differences in output signals from different brands and types of HD sources boxes.</p> <p><i>Note: Most High Definition receiver boxes also have picture-positioning controls in their menu systems. If the TV cursor controls run out of range before the picture is correctly positioned, the receiver box controls will need to be adjusted.</i></p>
<b>No photo, music or video play or in poor quality only</b>	<ul style="list-style-type: none"> <li>Verify if the source complies with a supported code.</li> </ul>
<b>No sound</b>	<ul style="list-style-type: none"> <li>Increase the VOLUME.</li> <li>Verify that the TV is not muted, press the <b>MUTE</b> button on the remote control.</li> <li>When no signal is detected, the TV automatically switches off the sound. This is proper operation and does not indicate a malfunction.</li> </ul>
<b>Good sound but poor color or no picture</b>	<ul style="list-style-type: none"> <li>Adjust the contrast, color, tint and brightness setting.</li> <li>Select Reset AV settings in the Installation menu.</li> </ul>
<b>Snowish picture and noise</b>	<ul style="list-style-type: none"> <li>Verify the antenna connection.</li> </ul>
<b>Television not responding to remote control</b>	<ul style="list-style-type: none"> <li>Verify whether the batteries are working. Replace if necessary.</li> <li>Clean the remote control sensor lens on the monitor.</li> <li>Operating range between TV and the remote control should not be &gt; 240".</li> <li>You can still use the buttons at the right side of your TV.</li> <li>Verify if the remote control is in the correct mode.</li> </ul>
<b>Control of accessory devices</b>	<ul style="list-style-type: none"> <li>The infrared signals of the screen may influence the reception sensibility of other peripherals Solution: replace the batteries of the remote control of other devices. E.g. keep away a wireless headphone from within a radius of 50".</li> </ul>

## Before Calling Service (continued)

Symptoms	Items to Check and Actions to follow
<b>The software will not install</b>	Possibly the operating system is wrong. Go to <a href="http://www.philips.com/support">www.philips.com/support</a> to see which operating systems are supported.
<b>No stable or not synchronized VGA picture</b>	Check if you have selected the correct VGA mode in your PC. See Annex 4, Issues referring to connected equipment with a HDMI connector, p. 65.
<b>Standby</b>	Your TV consumes energy in standby mode. Energy consumption contributes to air and water pollution.
<b>After improper shutdown</b>	If your TV has been shutdown in an improper way (e.g. power drop, power cord plug out), starting up the TV again will take a longer time than usual.

### If your problem is not solved

Turn your TV off and then on again once.

### Never attempt to repair a defective TV yourself.

Check with your dealer or call a TV technician.

### Telephone number Philips Customer Care Center: 1-888-PHILIPS (744-5477)

Please, have the Model and Product number which you can find at the back of your television set ready, before calling.

## Glossary

- 1080i** Provides 1080 lines of resolution. Displays images using interlaced scanning. 1080i is one of the formats used by HDTV (via HDMI, YPbPr, ...).
- 720p** Displays images using progressive scanning.
- CS** Digital Caption Service
- CC** Analog Caption Service
- DTV** A new technology for transmitting and receiving broadcast television signals. DTV provides higher resolution and improved sound quality over analog television.
- DV** Digital Video (from a camera)
- DVCR** Digital Video Recorder
- EAS** Emergency Alert System  
Method for use by cable TV systems to signal emergencies to digital terminal devices such as digital STV, digital TV receivers and digital VCRs. It allows a cable operator to disseminate emergency alert information related to state and local-level emergencies and warnings.
- NTSC** Analog signals
- PBS** Public Broadcast System

## Annex 1 - Philips TV software upgrade with portable memory

### Introduction

Philips offers software upgrade capability for your TV using portable memory. After you have completed a software upgrade, your TV will typically perform better.

What improvements are made depends on the upgrade software you are using as well as the software your TV contained before the upgrade.

You can execute the software upgrade procedure yourself. Be aware that the content of this document is addressing technical or software skilled users.

### To prepare a USB device for software upgrade

For the procedure you will require:

- a personal computer with web browsing capability;
- an archive utility that supports the ZIP-format (e.g. WinZip for Windows or Stuffit for Mac OS);
- a preferably empty USB memory stick.

New software can be obtained from your dealer or can be downloaded from the [www.philips.com/support](http://www.philips.com/support) website:

1. Go to [www.philips.com/support](http://www.philips.com/support) using the web browser on your PC.
2. Follow the procedure to find the information and the software related to your TV.
3. Select the latest software upgrade file and download it to your PC.
4. Decompress the ZIP-file and copy the file "autorun.upg" to the root directory of the USB portable memory.

**Note:** only use software upgrades that can be found on the [www.philips.com/support](http://www.philips.com/support) web site.

TV menu	
Installation	Software upgrade
Language	Current softw. info
Channels	Local upgrades
Preferences	
Connections	
Clock	
Reset AV settings	
Software upgrade	
Info	

### To verify the version of the TV software

Before you start the software upgrade procedure, it is advised to check what the current TV software is.

1. Select **Software Upgrade** in the Installation menu.
2. Press the cursor right.
  - ▷ The Software Upgrade menu moves to the left panel.
3. Select **Current Software Info** to observe the version and the description of the software currently installed on your TV.

**Note:** It is possible to upload a software version equal or lower than the current version. In this case only a manual software upgrade procedure is possible. See p. 60.

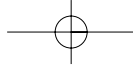

## Annex 1 (Continued)

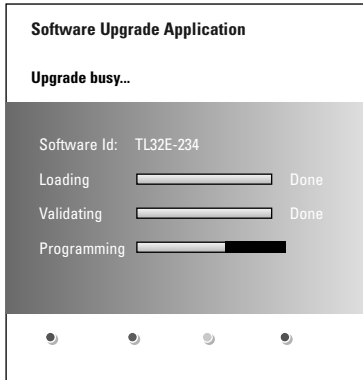

### Automatic software upgrade procedure

1. Turn off your TV and remove all memory devices.
2. Insert the portable memory that contains the downloaded software upgrade.
3. Switch on your TV with the **POWER** button on your remote control.
4. At startup the TV will scan the portable memory until it finds the update content. The TV will automatically go to the upgrade mode. After a few seconds it will display the status of the upgrade procedure.

#### Warning:

- you are not allowed to remove the portable memory during the software upgrade procedure;
- in case of a power drop during the upgrade procedure, don't remove the portable memory from the TV. The TV will continue the upgrade as soon as the power comes back;
- if an error occurs during the upgrade you should retry the procedure or contact your dealer.

5. When the software upgrade was successful, remove the portable memory and restart your TV with the **POWER** button on your remote control. Your TV will start up with the new software.

**Note:** once the upgrade is finished use your PC to remove the TV software from your portable memory.

### Manual software upgrade procedure

For a manual software upgrade copy the "autorun.upg" file in a directory called "Upgrades" located in the root of the portable memory. Rename this file as "firmware\_upgrade.upg".

1. Insert the portable memory that contains the downloaded software upgrade.
2. Select **Software Upgrade** in the Installation menu. Go to **Local upgrades**. The TV will list all compatible software available on the portable memory and display the data for each selected upgrade version.
3. Select the correct upgrade version and press the red color button to start the upgrade. Your TV will restart and will automatically go to the upgrade mode. After a few seconds it will display the status of the upgrade procedure.

**Warning:** if you try to upgrade to a software version equal or lower than the current version, a confirmation will be asked. Downgrading to older software should only be done in case of real necessity.

4. When the software upgrade was successful, remove the portable memory and restart your TV with the **POWER** button on your remote control. Your TV will start up with the new software.

TV menu	
Installation	Software upgrade
Language	Current softw. info
Channels	Local upgrades
Preferences	
Connections	
Clock	
Reset AV settings	
Software upgrade	
Info	

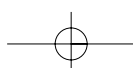

## Annex 2 - Philips TV-Slideshow Format with background music

### Notes:

- the latest version of this document can be found on the Philips support website ([www.philips.com/support](http://www.philips.com/support)).
- Use the type number of your TV to find this documentation and other related files.
- Philips can't be held responsible for any problems that may occur as a result of the content in this document. Errors reported to Philips will be adapted and published on the Philips support website as soon as possible.

### Introduction

This document explains how to make a Philips slideshow file with background audio. Be aware that the content of this document is addressing technical or software skilled users. To start the slideshow open the slideshow file in the Multimedia browser of your TV.

1. Press the **OPTION** button on the remote control after having inserted a USB device and switched on the TV.
2. Select **Multimedia** and press the cursor right.
3. Go to where you stored the slideshow file (.alb) on your portable memory.
4. Select the slideshow file and press the **OK** button to start the slide show.
5. To stop a slide show, press the **■** button.

### General Rules

- The slideshow will use plain ASCII XML syntax to allow the creation and editing of the slideshow files using simple tools.
- All references to network content must be based on the global address of the content.
- Content on a Portable Memory (PM) doesn't have a global address; as a result content from a PM can never be referenced from a slideshow not stored on the PM itself.
- To maintain portability, a slideshow stored on a PM should **ONLY** reference content on the same PM. Referencing global addresses can result in inconsistencies if the PM is used on a non-networked CE device. The latter is however not forbidden, it is only a recommendation.
- It is preferable that URL's referencing PM content are based on a relative path starting from the directory where the slideshow is stored. This path includes the device or drive name of the PM. An absolute path to content will also be supported.
  - relative path: pictures\test1.jpg, tamper.jpg, ..\new\bird.jpg, ...
  - absolute path: USB1:\pictures1\foo\_bar.jpg, C:\f1.jpg, \organization.jpg, ...

### General Format

The format and syntax below will be used to create the slideshow file (simple ascii text) with the extension .alb (.ALB). Examples: slshow1.alb, summer\_holiday\_2004.ALB, test.alb, ...  
The following syntax should be used to create the text file:

```
<?xml version="1.0" encoding="ISO-885h9-1" ?>
<philips-slideshow version="1.0" >
  <title>Title of the slideshow</title>
  <audio>audio_url</audio>
  <slide-duration>30</slide-duration>
  <slides>
    <slide>slide_1_url</slide>
    <slide>slide_2_url</slide>
    <slide>slide_3_url</slide>
    <slide>slide_4_url</slide>
    <slide>slide_5_url</slide>
    <slide>slide_6_url</slide>
    ...
    <slide>slide_N-1_url</slide>
    <slide>slide_N_url</slide>
  </slides>
</philips-slideshow>
```

## Annex 2 (Continued)

### Supported XML-tags

The following table gives a description of the XML syntax.

Tag Name	Use	Description
philips-slideshow	mandatory	Philips slideshow signature including the version.
title	optional	The title of the playlist.
audio	optional	The audio-URL following this tag will define the music playing in the background during the slideshow. A single song or playlist (.m3u & .pls) are the only valid audio references. Other reference will not result in any audio playback. If a single song is referenced the song will be repeated forever. If a playlist is referenced the playlist will be played in sequence with a repeat at the end of the playlist.
slide-duration	optional	The default display time (in 0,1 second) of a slide. The TV application isn't obliged to support this tag. The TV application can force the use of one or multiple predefined display times.
slides	mandatory	Identifies the slides to show.
slide	optional	Identifies the URL of the individual slide.

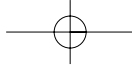

## Annex 3 - Philips TV - Digital camera and USB issues

### Notes:

- the latest version of this document can be found on the Philips support website ([www.philips.com/support](http://www.philips.com/support));
- the software of your TV is upgradeable. If you have problems first check if you have the latest software installed on your TV. The latest software, together with instructions, can be found on the Philips support website. Use the type number of your TV to find this documentation and other related files.
- Philips can't be held responsible neither for any errors in the content of this document nor for any problems as a result of the content in this document. Errors reported to Philips will be adapted and published on the Philips support website as soon as possible.

### Digital Camera Issues

If a USB connection between your digital camera and the TV isn't working, you can try the solutions below to resolve your problem.

- o Make sure your digital camera is switched on and verify if the configuration of your digital camera is correct (see the manual of your digital camera for more information).
- o Some digital cameras allow you to switch off the USB interface. Make sure that the USB interface is switched on before connecting to the TV.
- o If you have a digital camera with only internal memory (no removable memory) you can try to copy the content manually to a USB memory device using a personal computer.
- o Some digital cameras allow you to switch between PTP (Picture Transfer Protocol) or "PC Link" and USB Mass Storage. Make sure that you select USB Mass Storage or "PC Drive" on your digital camera.
- o If your camera supports different interface settings be sure to try them one by one or contact the reseller of your camera to find out the correct setting.

### USB Memory Device Issues

- o Devices connected to the USB port of your TV must be "Mass Storage Class" compliant. If your device (digital camera, MP3 player, portable harddisk, ...) is not "Mass Storage Class" compliant it will not be detected by the content browser of the TV.
- o The following subsets of the Mass Storage Class specification are supported:
  - The implementation of the TV is based on the "Universal Serial Bus Mass Storage Class Specification Overview" (v1.2, June 23, 2003) including all documents referenced by the document. The document can be found on the USB standardization website ([www.usb.org](http://www.usb.org)).
  - Full support of the USB Mass Storage Class Bulk-Only Transport (bInterfaceProtocol = 50h).
  - Full support of SubClass Code = 05h; SFF-8070i spec.
  - Full support of SubClass Code = 06h; SCSI transparent command set.
- o For large USB memory devices, when you are in the Content Browser, it may take a long time before you can access your files.
- o When using a USB portable harddisk: Due to the high power consumption of the harddisk, it is advised to use the external power supply of the portable harddisk to guarantee proper working under all conditions.

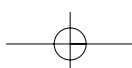

## Annex 4 - Issues referring to connected equipment with a HDMI connector

The **HDMI IN** connector allows the following TV and monitor display modes:

<b>HD</b>	Standard Definition TV (SDTV)	640x480i 720x480i
	Enhanced Definition TV (EDTV)	640x480p 720x480p
	High Definition TV (HDTV)	1920x1080i 1280x720p
<b>PC</b>	VGA	640x480
	SVGA	800x600
	XGA	1024x768

- If necessary, you can adjust the picture position to the centre of the screen with the cursor buttons.
- Due to legal requirements, it is possible that with certain copy protected PCM audio qualities from a peripheral equipment connected to the **HDMI** input, the Digital audio output signal is muted.
- Proper working is only guaranteed with HDMI compliant consumer products. Limit the cable length to maximum 5 m.
- In case no signal is detected from your HDMI equipment, turn off the HDMI equipment and then on again.

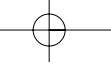

## Index

active control.....	19	game.....	45	uninstall channels.....	34
adjust picture menu settings ..	17	getting started.....	3-4	usb connector.....	45
adjust sound menu settings ..	20	glossary .....	58	usb device.....	41
adjust features menu settings.	22	HDMI connector.....	54,65	video equipment .....	47
alternate audio .....	21	headphone.....	45	volume.....	20
antenna .....	4	headphone volume .....	21	vcr .....	47
audio/video equipment		installation menu.....	30	weak channel installation .....	33
buttons .....	56	kensington security lock.....	68		
audio/video connections .....	44	language.....	30		
autoprogram .....	31	lock after.....	26		
auto surround.....	21	menu button .....	13		
avl (auto volume leveling) .....	21	movie ratings lock .....	27		
		multimedia browser .....	41		
balance.....	20	mute button .....	7		
batteries.....	5,67	navigate through the			
before calling service .....	57	menus .....	13-14		
brightness .....	17	ok button .....	6		
		on timer .....	29		
cable .....	4	pc.....	54		
camera.....	44	picture format.....	19		
camcorder .....	44	pin code .....	28		
captions service.....	22	pixel plus.....	18		
captions options.....	23-24	rear panel overview .....	46		
care of the screen.....	2	record a TV program .....	55		
change pin.....	28	recorder .....	47-49,51		
channel installation .....	31	recycling .....	67		
channel list.....	39	region ratings lock.....	28		
channel lock .....	26	remote control .....	6-8		
channel tuning.....	32	reset av settings .....	38		
child lock .....	26	safety warnings .....	2		
clear regions ratings .....	28	satellite receiver .....	51,52		
clock .....	37	select your connections .....	36		
closed captions .....	22	select connected devices .....	55		
code setup.....	28	set pin.....	28		
color .....	17	side connectors.....	44		
color enhancement.....	19	sharpness .....	17		
color buttons .....	6	sleeptimer .....	24		
color temperature .....	17	slideshow format.....	61		
comp. video connectors .....	47-54	software upgrade.....	59		
connections .....	36	sound mode .....	21		
contrast.....	17	standby button.....	6		
cursor buttons.....	6	store channels.....	31		
custom color temperature .....	18	time zone selection .....	37		
		tint.....	17		
daylight saving .....	37	turn the tv on.....	10		
delta volume.....	21	tv menu settings.....	15		
demo.....	29	tv ratings lock.....	26		
digital audio language .....	20				
digital surround receiver .....	55				
DNR .....	18				
DVD player.....	52				
DVD recorder .....	47				
dynamic contrast.....	18				
emergency alert signalling.....	35				
favorite button .....	6				
first time installation .....	10				

## Recycling

### Recycling

 The packaging of this product is intended to be recycled. Apply to the local authorities for correct disposal.

### Disposal of your old product

Your product is designed and manufactured with highly quality material and components, which can be recycled and reused.

Please inform yourself about the local separate collection system for electrical and electronic products. Please act according to your local rules and do not dispose of your old products with your normal household waste.

The correct disposal of your old product will help prevent potential negative consequences for the environment and human health.

### Disposal of batteries

The batteries supplied do not contain the heavy metals mercury and cadmium. Please check on how to dispose of exhausted batteries according to local regulations.

### Regulatory Notices - Federal Communications Commission Notice

This equipment has been tested and found to comply with the limits for a Class B digital device, pursuant to part 15 of the FCC Rules. These limits are designed to provide reasonable protection against harmful interference in a residential installation. This equipment generates, uses, and can radiate radio frequency energy and, if not installed and used in accordance with the instructions, may cause harmful interference to radio communications. However, there is no guarantee that interference will not occur in a particular installation. If this equipment does cause harmful interference to radio or television reception, which can be determined by turning the equipment off and on, the user is encouraged to try to correct the interference by one or more of the following measures:

- Reorient or relocate the receiving antenna.
- Increase the separation between the equipment and the receiver.
- Connect the equipment into an outlet on a circuit different from that to which the receiver is connected.
- Consult the dealer or an experienced radio or television technician for help.

#### Modifications -

The FCC requires the user to be notified that any changes or modifications made to this device that are not expressly approved by Philips Consumer Electronics may void the user's authority to operate the equipment.

#### Cables -

Connections to this device must be made with shielded cables with metallic RFI/EMI connector hoods to maintain compliance with FCC Rules and Regulations.

#### Canadian notice -

This Class B digital apparatus meets all requirements of the Canadian Interference-Causing Equipment Regulations.

#### Avis Canadien -

Cet appareil numérique de la classe B respecte toutes les exigences du Règlement sur le matériel brouilleur du Canada.

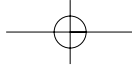

## Product information

- Your TV consumes energy in standby mode. Energy consumption contributes to air and water pollution. Very low standby power consumption.
- Specifications: see the product leaflet on [www.philips.com/support](http://www.philips.com/support).
- If you need further assistance, please call the customer support service in your country. The corresponding telephone numbers and addresses are given in the supplied Worldwide guarantee booklet.

### Plasma display characteristics

This Plasma display is designed to be used at altitudes up to 6562 ft above sea level (and/or local air pressure equal or above 800 hPa). Operating this set at higher altitude (lower air pressure) is possible. However, at high altitudes (or local air pressure equal or below 800 hPa) the picture on this display may become unstable and picture performance can deteriorate. In addition, the plasma display may produce a humming sound in these conditions.

These possible adverse effects relate to the altitude and are common of all plasma displays. Once the set is brought below approx 6562 ft (and/or local air pressure equal or above 800 hPa) its function will most likely return to normal.

**Note:** Transportation at high altitudes has no negative effect on the set or picture performance.

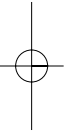
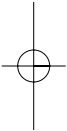

### Kensington Security Slot (if present)

Your TV is equipped with a Kensington Security Slot, to prevent it from getting stolen. An anti-theft Kensington lock has to be purchased separately. The Kensington lock is a plastic-coated steel cable with a lock. One end has to be fixed to the opening of the TV and locked with a special button. The other end is attached to a fixed point.

*® Kensington and MicroSaver are registered US trademarks of ACCO World Corporation with issued registrations and pending applications in other countries throughout the world. All other registered and unregistered trademarks are the property of their respective owners.*

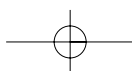

## PHILIPS LIMITED WARRANTY ONE (1) YEAR

### WARRANTY COVERAGE:

PHILIPS warranty obligation is limited to the terms set forth below.

### WHO IS COVERED:

Philips warrants the product to the original purchaser or the person receiving the product as a gift against defects in materials and workmanship as based on the date of original purchase ("Warranty period") from an Authorized Dealer. The original sales receipt showing the product name and the purchase date from an authorized retailer is considered such proof.

### WHAT IS COVERED:

The Philips warranty covers new products if a defect arises and a valid claim is received by Philips within the Warranty Period.

At its option, Philips will either (1) repair the product at no charge, sing new or refurbished replacement parts, or (2) exchange the product with a product that is new or which has been manufactured from new, or serviceable used parts and is at least functionally equivalent or most comparable to the original product in Philips current inventory, or (3) refund the original purchase price of the product.

Philips warrants replacement products or parts provided under this warranty against defects in materials and workmanship from the date of the replacement or repair for ninety (90) days or for the remaining portion of the original product's warranty, whichever provides longer coverage for you. When a product or part is exchanged, any replacement item becomes your property and the replaced item becomes Philips' property.

When a refund is given, your product becomes Philips' property.

**Note: Any product sold and identified as refurbished or renewed carries a ninety (90) day limited warranty.**

**Replacement product can only be sent if all warranty requirements are met. Failure to follow all requirements can result in delay.**

### WHAT IS NOT COVERED - EXCLUSIONS AND LIMITATIONS

This Limited Warranty applies only to the new products manufactured by or for Philips that can be identified by the trademark, trade name, or logo affixed to it. This Limited Warranty does not apply to any non-Philips hardware product or any software, even if packaged or sold with the product. Non-Philips manufacturers, suppliers, or publishers may provide a separate warranty for their own products packaged with the bundled product.

Philips is not liable for any damage to or loss of any programs, data, or other information stored on any media contained within the product, or any non-Philips product or part not covered by this warranty. Recovery or reinstallation of programs, data or other information is not covered under this Limited Warranty.

This warranty does not apply (a) to damage caused by accident, abuse, misuse, misapplication, or non-Philips product, (b) to damage caused by service performed by anyone other than Philips or Philips Authorized Service Location, (c) to a product or a part that has been modified without the written permission of Philips, or (d) if any Philips serial number has been removed or defaced, or (e) product, accessories or consumables sold "AS IS" without warranty of any kind by including refurbished Philips product sold "AS IS" by some retailers.

### This Limited Warranty does not cover:

- Shipping charges to return defective product to Philips.
- Labor charges for installation or setup of the product, adjustment of customer controls on the product, and installation or repair of antenna systems outside of the product.
- Product repair and/or part replacement because of improper installation, connections to improper voltage supply, abuse, neglect, misuse, accident, unauthorized repair or other cause not within the control of Philips.
- Damage or claims for products not being available for use, or for lost data or lost software.
- Damage occurring to product during shipping.
- A product that requires modification or adaptation to enable it to operate in any country other than the country for which it was designed, manufactured, approved and/or authorized, or repair of products damaged by these modifications.
- A product used for commercial or institutional purposes (including but not limited to rental purposes).
- Product lost in shipment and no signature verification receipt can be provided.
- Failure to operate per Owner's Manual.

### TO OBTAIN ASSISTANCE IN THE U.S.A., PUERTO RICO, OR U.S. VIRGIN ISLANDS....

Contact Philips Customer Care Center at:  
1-888-PHILIPS (1-888-744-5477)

### TO OBTAIN ASSISTANCE IN CANADA....

1-800-661-6162 (French speaking)  
1-888-PHILIPS (1-888-744-5477) (English of Spanish speaking)

REPAIR OR REPLACEMENT AS PROVIDED UNDER THIS WARRANTY IS THE EXCLUSIVE REMEDY FOR THE CONSUMER. PHILIPS SHALL NOT BE LIABLE FOR ANY INCIDENTAL OR CONSEQUENTIAL DAMAGES FOR BREACH OF ANY EXPRESS OR IMPLIED WARRANTY ON THIS PRODUCT. EXCEPT TO THE EXTENT PROHIBITED BY APPLICABLE LAW, ANY IMPLIED WARRANTY OF MERCHANTABILITY OR FITNESS FOR A PARTICULAR PURPOSE ON THIS PRODUCT IS LIMITED IN DURATION TO THE DURATION OF THIS WARRANTY.

Some states do not allow the exclusions or limitation of incidental or consequential damages, or allow limitations on how long an implied warranty lasts, so the above limitations or exclusions may not apply to you.

*This warranty gives you specific legal rights. You may have other rights which vary from state/province to state/province.*

**Philips, P.O. Box 671539, Marietta, GA. 30006-0026**