

Register your product and get support at  
[www.philips.com/welcome](http://www.philips.com/welcome)

8000 series Smart LED TV

40PFL8007  
46PFL8007  
55PFL8007



# User manual

**PHILIPS**

---

# Contents

- 1 Tour 2**
  - 1.1 Smart TV 2
  - 1.2 App gallery 2
  - 1.3 Rental videos 2
  - 1.4 Online TV 2
  - 1.5 Social networks 2
  - 1.6 Skype 3
  - 1.7 Smartphones and tablets 3
  - 1.8 Pause TV and recordings 3
  - 1.9 Gaming 3
  - 1.10 EasyLink 4
- 2 Setting up 5**
  - 2.1 Tips on placement 5
  - 2.2 Power cable 5
  - 2.3 Antenna 5
  - 2.4 Satellite dish 5
  - 2.5 Network 5
  - 2.6 Connect devices 7
  - 2.7 Setup menu 16
  - 2.8 TV stand and wall mounting 16
  - 2.9 Safety and care 17
- 3 TV 18**
  - 3.1 Switch on 18
  - 3.2 Remote control 18
  - 3.3 Watch TV 22
  - 3.4 TV guide 28
  - 3.5 Switch to devices 29
  - 3.6 Subtitles and languages 30
  - 3.7 Timers and clock 31
  - 3.8 Picture settings 32
  - 3.9 Sound settings 33
  - 3.10 Ambilight settings 34
  - 3.11 Universal access 35
- 4 Watch satellite 37**
  - 4.1 Satellite channels 37
  - 4.2 Satellite installation 39
- 5 3D 42**
  - 5.1 What you need 42
  - 5.2 Your 3D glasses 42
  - 5.3 Watch 3D 42
  - 5.4 Optimal 3D viewing 43
  - 5.5 Health warning 43
  - 5.6 Care of the 3D glasses 43
- 6 Smart TV 44**
  - 6.1 Home menu 44
  - 6.2 Smart TV Apps 44
  - 6.3 Videos, photos and music 46
  - 6.4 Pause TV 48
  - 6.5 Recording 49
  - 6.6 MyRemote App 50
- 7 Skype 53**
  - 7.1 What is Skype? 53
  - 7.2 Start Skype 53
  - 7.3 Contacts 54
  - 7.4 Calling on Skype 55
  - 7.5 Skype Credit 56
  - 7.6 Skype settings 56
  - 7.7 Sign out 57
  - 7.8 Terms of Use 57
- 8 Games 58**
  - 8.1 Play a game 58
  - 8.2 Two-player games 58
- 9 TV Specifications 59**
  - 9.1 Environmental 59
  - 9.2 Power 60
  - 9.3 Reception 60
  - 9.4 Display 60
  - 9.5 Sound 60
  - 9.6 Multimedia 61
  - 9.7 Connectivity 61
  - 9.8 Dimensions and weights 61
- 10 TV Software 62**
  - 10.1 Software version 62
  - 10.2 Software update 62
  - 10.3 Open source software 62
  - 10.4 Open source license 62
- 11 Support 63**
  - 11.1 Register 63
  - 11.2 Using help and search 63
  - 11.3 Online support 63
  - 11.4 Consumer Care 63
- 12 Copyrights and licences 64**
  - 12.1 HDMI 64
  - 12.2 Dolby 64
  - 12.3 Skype 64
  - 12.4 DivX 64
  - 12.5 Microsoft 64
  - 12.6 Other trademarks 64
- Index 65**

# Tour

## 1.1

## Smart TV

Connect this **Philips Smart LED TV** to the Internet and discover a new world of television. You can make a wired connection to your router or you can link up wirelessly with Wi-Fi.

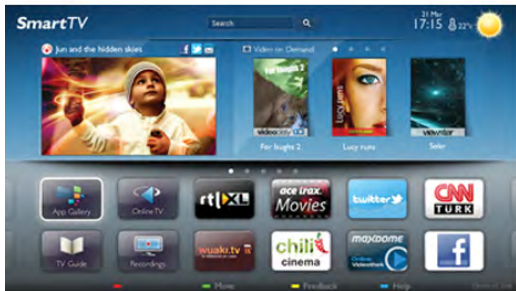

With the TV connected to your home network, a smartphone can show a photo on TV, you can play videos stored on your computer or control the TV with your tablet.

With your TV connected to the Internet, you can watch a rental video from an online video store, read the online TV guide or record your favourite TV show on a USB Hard Drive. The Smart TV Apps add to the fun with all sorts of entertainment and convenient services.

In **Help**, press **≡ List** and look up **Smart TV** for more information.

## 1.2

## App gallery

Open the **App gallery** in Smart TV to browse the Apps, the collection of tailored websites for TV.

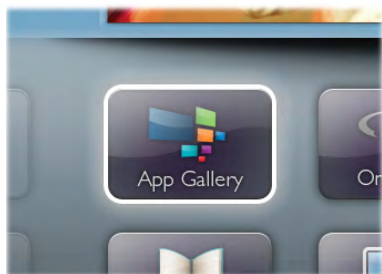

Find the App for YouTube videos, a national newspaper, an online photo album, Facebook, Twitter, etc. There are Apps to rent a video from an online video store and Apps for watching programmes you missed. If the App gallery does not hold what you are looking for, try the World Wide Web and surf the Internet on TV.

In **Help**, press **≡ List** and look up **App gallery** for more information.

## 1.3

## Rental videos

To watch a **rental video**, you don't need to leave your home. Simply rent the latest movie from your regional online video store.

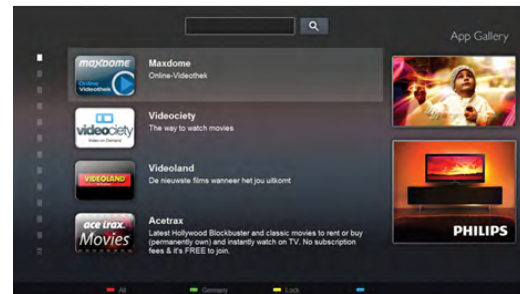

Start Smart TV and add the video store App to the Smart TV start page.

Open the video store App, create your personal account, select the movie and press play.

No fuss with downloading, you can watch the movie immediately\*.

In **Help**, press **≡ List** and look up **Rental videos** for more information.

\* Depending on the video streaming service of the selected video store.

## 1.4

## Online TV

With the **Online TV** Apps of Smart TV (streaming TV), you can watch a TV programme you just missed or watch a programme when it suits you best.

Look for the broadcaster logo in the App gallery.

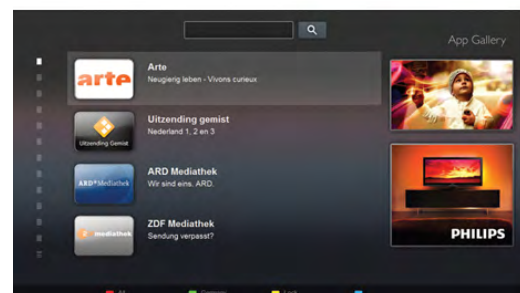

In **Help**, press **≡ List** and look up **Online TV** for more information.

1.5

## Social networks

No need to get up to check your friend's messages on your computer. Open Smart TV, select your **social network** page and send a message back from your couch.



Smart TV supports the popular social networks Facebook and Twitter.

In **Help**, press **≡ List** and look up **App gallery** for more information.

1.6

## Skype

With **Skype™** you can make video calls on your TV for free.



You can call and see your friends from anywhere in the world. To make a video call, you need a camera with a built-in microphone and a good connection to the Internet.

In **Help**, press **≡ List** and look up **Skype** for more information.

1.7

## Smartphones and tablets

To use your smartphone or tablet as a TV remote control or as your media controller, download the **Philips MyRemote** app from your smartphone or tablet app store.



Operate your TV from your smartphone or tablet, switch channels or change the volume. With the MyRemote app, you can use your phone or tablet to send photos, music or videos from your computer to your TV. And with MyRemote app on a tablet, you can call up the TV guide, read about the programmes and switch the TV to a channel with a simple tap of your finger. The MyRemote app is available for iOS and Android.

In **Help**, press **≡ List** and look up **MyRemote app** for more information.

1.8

## Pause TV and recordings

If you connect a USB Hard Drive, you can **pause and record a broadcast** from a digital TV channel.



Pause your TV and answer that urgent phone call or simply take a break during a sports match, while the TV stores the broadcast on the USB Hard Drive. You can start watching again later.

With a USB Hard Drive connected, you can also record digital broadcasts. You can Record while you are watching a program or schedule a recording of an upcoming programme.

In **Help**, press **≡ List** and look up **Pause TV** or **Recording** for more information.

1.9

## Gaming

If you select your **game console** in the Home menu, the TV switches to the settings ideal for gaming automatically.

If you play a multi-player game with split screens, you can set the TV to show each screen as a full screen. Each player can focus on his own game to play.



Player 1

Player 2

The TV uses 3D technology to show both screens. To play a two-player game with two different full screen pictures, you need a pair of 3D glasses for each player.

In **Help**, press **≡ List** and look up **Game console** or **Two-player games** for more information.

---

## 1.10

# EasyLink

With **EasyLink** you can operate a connected device, like a Blu-ray Disc player, with the remote control of the TV. EasyLink uses HDMI CEC to communicate with the connected devices.

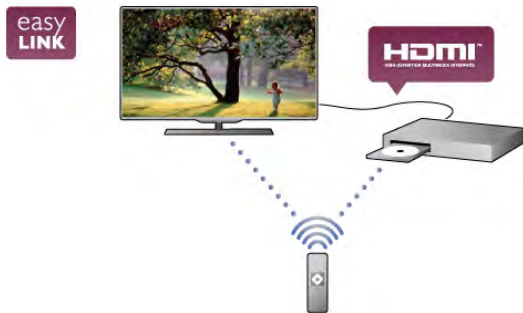

In **Help**, press **≡ List** and look up **EasyLink** for more information.

## Setting up

### 2.1

## Tips on placement

- Position the TV where light does not shine directly on the screen.
- Dim lighting conditions in the room for best Ambilight effect.
- Position the TV up to 25 cm away from the wall for the best Ambilight effect.
- The ideal distance to watch TV from is three times its diagonal screen size. When seated, your eyes should be level with the centre of the screen.
- For best sound, place the TV on a hard surface.

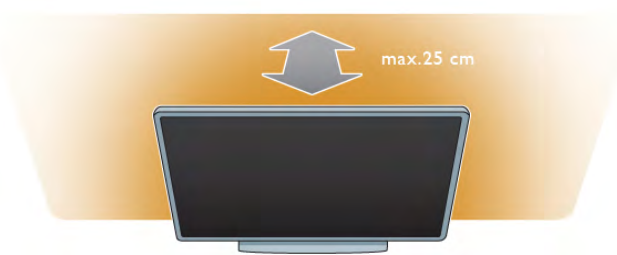

### 2.2

## Power cable

Insert the power cable into the **POWER** socket of the TV. Make sure the power cable is securely inserted into the TV. Make sure that the power plug in the wall socket is accessible at all times.

When disconnecting the power cable, always pull the plug, never the cable.

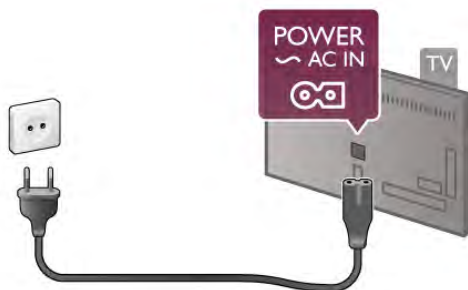

Although this TV has a very low standby power consumption, unplug the power cable to save energy if you do not use the TV for a long period of time.

In **Help**, press **≡ List** and look up **Standby** for more information on switching the TV on and off.

### 2.3

## Antenna

Locate the antenna connection at the back of the TV. Insert the antenna cable securely into the **Antenna** socket.

You can connect your own antenna or connect to an antenna signal from an antenna distribution system (common in certain regions). Use an IEC Coax 75 Ohm RF antenna connector.

Use this antenna connection for DVB-T and DVB-C input signals.

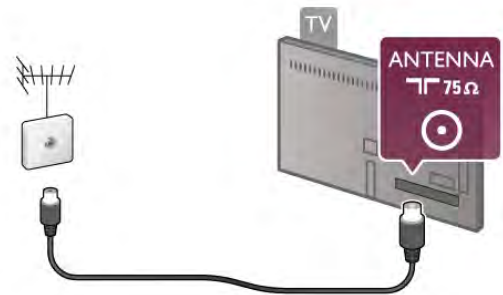

### 2.4

## Satellite dish

Locate the F-type satellite connection at the back of the TV. Attach the cable from your satellite dish to this connection.

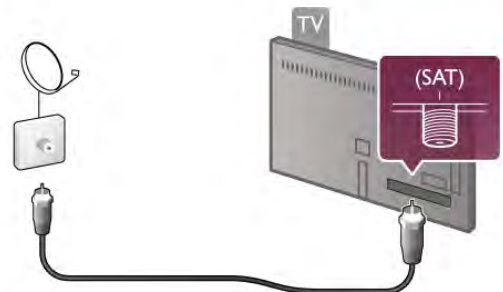

### 2.5

## Network

### Wireless connection

#### What you need

To connect the TV wirelessly to the Internet, you need a **wireless router**. Use a high-speed (broadband) connection to the Internet.



## DLNA

The TV uses the DLNA protocol to find and open files on other devices in your wireless network, like your computer or NAS device. You can use a computer with a Microsoft Windows XP, Vista or Windows 7, Mac OSX or Linux-based operating system.

## Media server software

With media server software on your computer, you can open your photos, music and videos stored on your computer on your TV screen.

Use a recent version of media server software like Windows Media Player 11, Twonky™ or similar\*.

Install the software on your computer and set it up to share your media files with the TV. Read the manual of the media server software for more information.

To open your files on the TV, the media server software must be running on your computer.

\* In **Help**, press **≡ List** and look up **Media server software, supported** for an overview of supported media server software.

## Make the connection

Follow steps **1** to **5**.

**Step 1** - Make sure that the router of your wireless network is switched on.

**Step 2** - Press **⏠** and select **⚙ Setup** and press **OK**.

**Step 3** - Select **Connect to network** and press **OK**.

**Step 4** - Select **Wireless** and press **OK**.

**Step 5** - Select **Scan** to scan for your wireless network. If you have a router with WPS (Wi-Fi Protected Setup), you can select **WPS**. Select your choice and press **OK**.

### - Scan

Select **Scan** to scan for your wireless network (your wireless router). The TV might find several wireless networks in your proximity.

### - WPS

If your router has WPS, you can directly connect to the router without scanning. Go to the router, press the **WPS** button and return to the TV within 2 minutes. Then press **Connect** to make the connection.

If you have devices in your wireless network that use the WEP security encryption system, you cannot use WPS.

If you must use the **WPS pin code** to connect, select **Scan** instead of WPS.

**Step 6** - In the list of networks found, select your wireless network and press **OK**.

If your network is not in the list because the network name is hidden (you switched off the SSID broadcast of the router), select **Manual entry** to enter the network name yourself.

**Step 7** - Depending on the type of router, you can now enter your encryption key (WEP, WPA or WPA2). If you entered the encryption key for this network before, you can select **Next** to make the connection immediately.

If your router supports WPS or WPS pin, you can select **WPS**, **WPS pin** or **Standard**. Select your choice and press **OK**.

### - Standard

Select **Standard** to enter the encryption key (password, passphrase or security key) manually. You can use the keyboard on the RC to enter the encryption key. Once you have entered the key, press **Connect**.

### - WPS pin

To make a secured WPS connection with a PIN code, select **WPS pin** and press **OK**. Write down the 8-digit PIN code shown and enter it in the router software on your PC. Return to the TV and press **Connect**. Consult the router manual on where to enter the PIN code in the router software.

**Step 8** - A message will be shown when the connection is successful.

## Network configuration

If the connection fails, you can check the DHCP setting of the router. DHCP should be set to **On**.

Alternatively, if you are an advanced user and want to install your network with static IP addressing, set the TV to Static IP. To set the TV to Static IP, press **⏠** and select **⚙ Setup** and press **OK**. Select **Network settings > Network configuration > Static IP**. With Static IP selected in the menu, you can set the IP address and other necessary settings in **Static IP configuration** in the same menu.

## Network problems

### Wireless network not found or distorted

- Microwave ovens, DECT phones or other Wi-Fi 802.11b/g/n devices in your proximity might disturb the wireless network.
- Make sure that the firewalls in your network allow access to the TV's wireless connection.
- If the wireless network does not work properly in your home, try the wired network installation.

### Internet does not work

- If the connection to the router is OK, check the router connection to the Internet.

### The PC and Internet connection are slow

- Look in your wireless router's user manual for information on indoor range, transfer rate and other factors of signal quality.
- Use a high-speed (broadband) Internet connection for your router.

## Wired connection

### What you need

You need a network **router** to connect the TV to the Internet. Use a router with a high-speed (broadband) connection to the Internet.

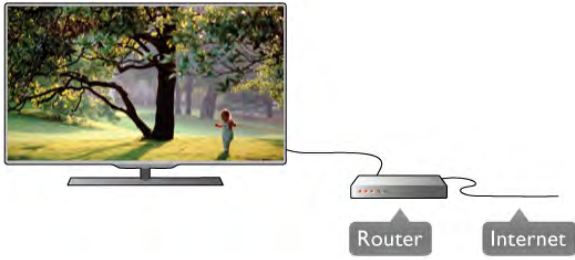

### Installation

Follow steps **1** to **5**.

**1** - Connect the router to the TV with a network cable (Ethernet cable\*\*).

**2** - Make sure that the router is switched on.

**3** - Press **Home** and select **Setup** and press **OK**.

**4** - Select **Connect to network** and press **OK**.

**5** - Select **Wired** and press **OK**.

The TV constantly searches for the network connection. A message will be shown when the connection is successful.

### Network configuration

If the connection fails, you can check the DHCP setting of the router. DHCP should be set to On.

Alternatively, if you are an advanced user and want to install your network with static IP addressing, set the TV to Static IP. To set the TV to Static IP, press **Home** and select **Setup** and press **OK**.

Select **Network settings** > **Network configuration** > **Static IP**. With Static IP selected in the menu, you can set the IP address and other necessary settings in **Static IP configuration** in the same menu.

### DLNA

The TV uses the DLNA protocol to find and open files on other devices in your network, like your computer. You can use a computer with a Microsoft Windows XP, Vista or Windows 7, Mac OSX or Linux operating system.

### Media server software

With media server software on your computer, you can open your photos, music and videos stored on your computer on your TV screen.

Use a recent version of media server software like Windows Media Player 11, Twonky™ or similar\*.

Install the software on your computer and set it up to share your media files with the TV. Read the manual of the media server software for more information.

To open your files on TV, the media server software must be running on your computer.

\* In **Help**, press **Menu** **List** and look up **Media server software, supported** for an overview of supported media server software.

\*\*To fulfill EMC regulations, use a shielded FTP Cat. 5E Ethernet cable.

## Network settings

To open the Network settings, press **Home** and select **Setup** and press **OK**.

Select **Network settings** and press **OK**.

### View network settings

All current network settings are shown here. The IP and MAC address, signal strength, speed, encryption method, etc.

### Network type

Sets the network to Wired or Wireless.

### Network configuration

Sets the network configuration to DHCP & Auto IP or Static IP.

### Static IP configuration

If Static IP is set, you can set all necessary static IP settings here.

### Digital Media Renderer - DMR

To receive multimedia files from smartphones or tablets, set the DMR to On.

### TV network name

If you have more than one TV in your network, you can rename the TVs here.

### Clear Internet memory

With Clear Internet memory you clear all Internet files stored on your TV. You clear your Philips Smart TV registration and parental rating setting, your video store app logins, all Smart TV app favourites, Internet bookmarks and history. Interactive MHEG applications can also save so-called 'cookies', on your TV. These files will also be cleared.

2.6

## Connect devices

### Tips on connections

#### Connectivity guide

Always connect a device to the TV with the **highest quality connection available**. Also, use good quality cables to ensure a good transfer of picture and sound.

If you need help to connect several devices to the TV, you can visit the **Philips TV connectivity guide**. The guide offers information on how to connect and which cables to use.

Go to [www.connectivityguide.philips.com](http://www.connectivityguide.philips.com)

#### Antenna

If you have a Set-top box (a digital receiver) or Recorder, connect the antenna cables to run the **antenna signal** through the Set-top box and/or Recorder first before it enters the TV. In this way, the antenna and the Set-top box can send possible additional channels to the Recorder to record.



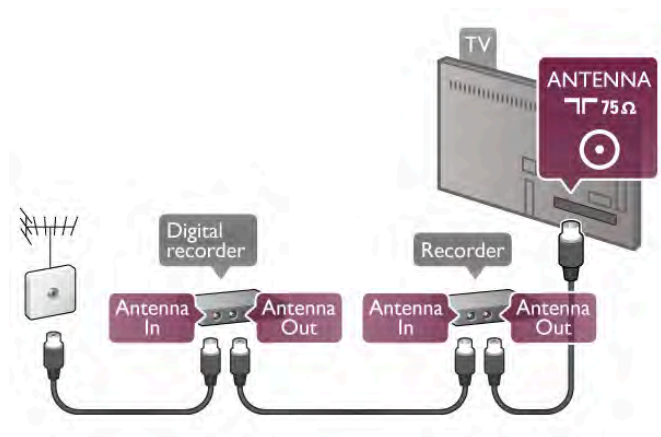

## HDMI

An **HDMI** connection has the best picture and sound quality. One HDMI cable combines video and audio signals. Use an HDMI cable for High Definition (HD) TV signals. For best signal quality transfer, do not use an HDMI cable longer than 5 m.



### EasyLink HDMI CEC

If your devices are connected with HDMI and have EasyLink, you can operate them with the TV remote control. EasyLink HDMI CEC must be switched on on the TV and the connected device.

In **Help**, press **≡ List** and look up **EasyLink HDMI CEC** for more information on using EasyLink.

### HDMI ARC

All of the HDMI connections on the TV have ARC (Audio Return Channel).

If the device, typically a Home Theatre System (HTS), also has the HDMI ARC connection, connect it to any of the HDMI connections on this TV. With the HDMI ARC connection, you do not need to connect the extra audio cable that sends the sound of the TV picture to the HTS. The HDMI ARC connection combines both signals.

You can use any HDMI connection on this TV to connect the HTS but ARC is only available for 1 device/connection at a time.

In case you prefer to switch off ARC on the HDMI connections, press **🏠** and select **⚙️ Setup** and press **OK**. Select **TV settings > Sound > Advanced > HDMI ARC**.

### DVI to HDMI

Use a DVI to HDMI adapter if your device only has a DVI connection. Use one of the HDMI connections and add an Audio L/R cable (mini-jack 3.5 mm) to Audio In VGA/DVI for sound, on the back of the TV.

### Copy protection

DVI and HDMI cables support HDCP (High-bandwidth Digital Content Protection). HDCP is a copy protection signal that prevents copying content from a DVD disc or Blu-ray Disc. Also referred to as DRM (Digital Rights Management).

## Y Pb Pr

**Component Video YPbPr** is a high quality connection. The YPbPr connection can be used for High Definition (HD) TV signals. Next to the Y, Pb and Pr signals add the Audio Left and Right signals for sound.

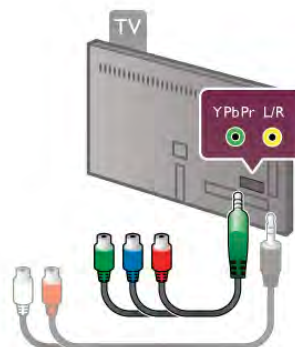

Use the supplied YPbPr adapter cable to connect your device. Match the YPbPr (green, blue, red) connector colours with the cable plugs when you connect. Use a Audio L/R cinch to mini-jack (3.5mm) adapter cable (not supplied) if your device also has sound.

## SCART

**SCART** is a good quality connection. The SCART connection can be used for CVBS and RGB video signals but cannot be used for High Definition (HD) TV signals. The SCART connection combines video and audio signals.

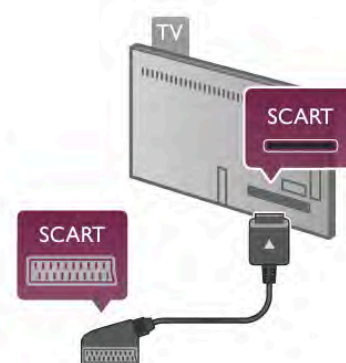

Use the supplied SCART adapter cable to connect your device.

## Audio Out - Optical

**Audio Out - Optical** is a high quality sound connection. This optical connection can carry 5.1 audio channels. If your audio device, typically a Home Theatre System (HTS), has no HDMI ARC connection, you can connect this sound cable to an Audio In - Optical connection on the HTS. This Audio cable will send the sound of the TV to the HTS.



You can set the type of the audio out signal to fit the audio capabilities of your Home Theatre System. In **Help**, press **≡ List** and look up **Audio Out settings** for more information.

If the sound does not match the video on screen, you can adjust the audio to video synchronization. In **Help**, press **≡ List** and look up **Audio to video sync** for more information.

## VGA

Use a **VGA** cable (D-sub 15 connector) to connect a computer to the TV. With the VGA connection you can use the TV as a computer monitor. You can add an **Audio L/R** cable for sound (mini-jack 3.5 mm).



You can also connect your computer wirelessly, to watch the multi media files stored on your computer on your TV screen. In **Help**, press **≡ List** and look up **Network, wireless** for more information.

## EasyLink HDMI CEC

### HDMI CEC

With **EasyLink** you can operate a connected device with the TV remote control. EasyLink uses HDMI CEC\* to communicate with the connected devices. Devices must support HDMI CEC and must be connected with an HDMI connection.

\* *Consumer Electronics Control*



### EasyLink setup

The TV comes with EasyLink switched on. Make sure that all HDMI CEC settings are properly set up on the connected EasyLink devices. EasyLink might not work with devices from other brands.

### HDMI CEC on other brands

The HDMI CEC functionality has different names on different brands. Some examples are: Anynet, Aquos Link, Bravia Theatre Sync, Kuro Link, Simplink and Viera Link. Not all brands are fully compatible with EasyLink.

Example HDMI CEC branding names are property of their respective owners.

### Operate devices

To operate a device connected to HDMI and set up with EasyLink, select the device -or its activity- in the list of TV connections. Press **⏏ SOURCE**, select a device connected to an HDMI connection and press **OK**.



Once the device is selected, the TV remote control can control the device. However the **🏠** (Home) and **⏏** **OPTIONS** keys and some other typical TV keys, like **Ambilight**, are not forwarded to the device.

If the key you need is not on the TV remote control, you can select the key in the Options menu. Press **⏏** **OPTIONS** and select **📄 Controls** in the menu bar. Select the device key you need on screen and press **OK**.

Some very specific device keys might not be available in the Controls menu.

### EasyLink settings

The TV comes with all EasyLink settings switched on. You can switch off any EasyLink setting independently.

#### EasyLink

To switch off EasyLink completely, press **🏠** and select **⚙ Setup** and press **OK**. Select **TV settings > General settings > EasyLink > EasyLink**. Select **Off** and press **OK**.

#### EasyLink Remote Control

If you want devices to communicate but you don't want to operate them with the TV remote control, you can switch off EasyLink remote control separately.

In the EasyLink settings menu, select **EasyLink Remote Control** and select **Off**.

#### Pixel Plus link

Some devices, a DVD or Blu-ray Disc player, might have their own picture quality processing. To avoid bad picture quality caused by interference with the TV processing, the picture processing of these devices should be disabled. The TV comes with Pixel Plus link switched on and disables the picture quality processing of recent Philips devices connected to the TV. To switch off Pixel Plus link, in the EasyLink settings menu, select **Pixel Plus link** and select **Off**.

#### Auto subtitle shift

If you play a DVD or Blu-ray Disc on a Philips disc player that supports subtitles, the TV can move the subtitles upwards. Subtitles will be visible whatever Picture format you select. The TV comes with Auto subtitle shift switched on. To switch off Auto subtitle shift, in the EasyLink settings menu, select **Auto subtitle shift** and select **Off**.

---

## Common Interface CAM

---

### CI+

This TV is ready for the CI+ Conditional Access.

With CI+ you can watch premium HD programmes, like movies and sports, offered by digital TV broadcasters in your region. These programmes are scrambled by the TV broadcaster and descrambled with a prepaid CI+ module. Digital TV broadcasters provide this CI+ module (Conditional Access Module - CAM) when you subscribe to their premium programmes. These programmes have a high level of copy protection.

Contact a digital TV broadcaster for more information on terms & conditions.

In **Help**, press **≡ List** and look up **Common Interface CAM** for more information on connecting a CAM.



### CAM

#### Insert a CAM module

Switch off the TV before inserting a CAM. Look on the CAM for the correct method of insertion. Incorrect insertion can damage the CAM and the TV.



Use the Common Interface slot on the left side of the TV to insert the CAM card\*. Gently insert the CAM as far as it will go and leave it in the slot permanently. It may take a few minutes before the CAM is activated. Removing the CAM will deactivate the broadcast service on TV.

\* The Common Interface slot accepts a PC card (PCMCIA) in which you insert a smart card. Both cards should be supplied by the TV broadcaster.

If a CAM is inserted and subscription fees have been paid, (connection methods can differ), you can watch the TV broadcast. The inserted CAM is exclusively for your TV.

#### CAM settings

To set passwords or PIN codes for the CAM TV broadcast, press **⏠** and select **⚙ Setup** and press **OK**. Select **Channel settings > Common Interface**. Select the CAM TV broadcaster and press **OK**.

---

## Set-top box STB

Use 2 antenna cables to connect the antenna to the Set-top box (a digital receiver) and the TV.

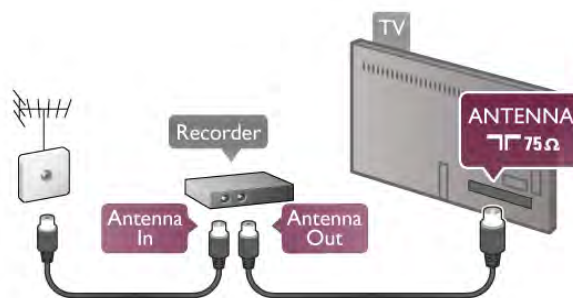

Next to the antenna connections, add an HDMI cable to connect the Set-top box to the TV. Alternatively, you can use a SCART cable if the Set-top box has no HDMI connection.

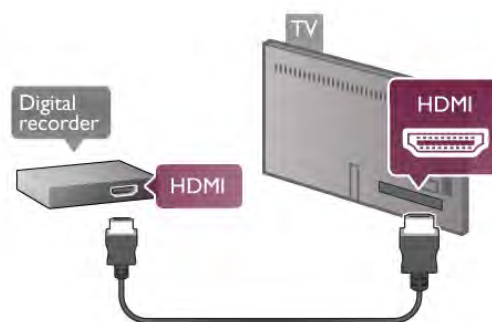

#### Switch off timer

Switch off this automatic timer, if you only use the remote control of the Set-top box. Do this to prevent the TV to switch off automatically after a 4 hour period without a key press on the remote control of the TV.

To switch off the Switch off timer, press **⏠** and select **⚙ Setup** and press **OK**. Select **TV settings > General settings > Switch off timer** and select **Off**.

---

## Satellite receiver

Connect the dish antenna cable to the Satellite receiver.

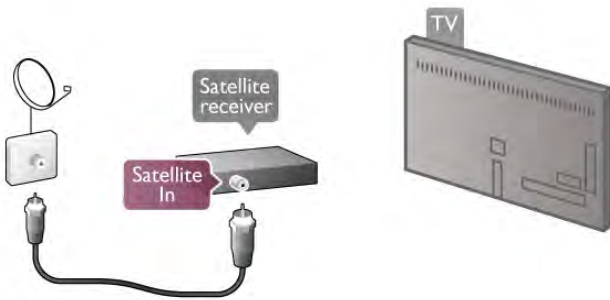

Next to the antenna connection, add an HDMI cable to connect the device to the TV. Alternatively, you can use a SCART cable if the device has no HDMI connection.

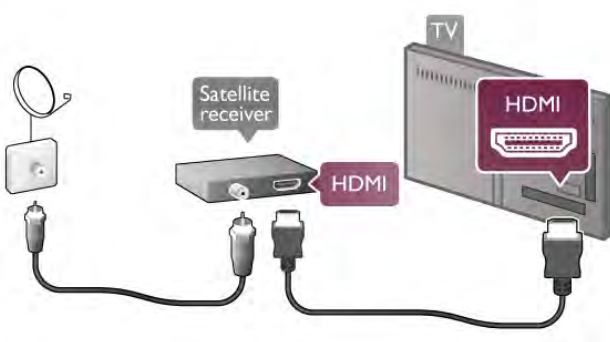

### Switch off timer

Deactivate the Switch off timer, if you only use the remote control of the Satellite receiver. Do this to prevent the TV to switch off automatically after a 4 hour period without a key press on the remote control of the TV.

To deactivate, press **Home** and select **Setup** and press **OK**. Select **TV settings** > **General settings** > **Switch off timer** and set the slider bar to **0**.

---

## Home Theatre System (HTS)

### Connect

Use an HDMI cable to connect a Home Theatre System (HTS) to the TV. You can connect a Philips Soundbar or an HTS with a built-in disc player.

Alternatively, you can use a SCART cable if the device has no HDMI connection.

### HDMI ARC

If your Home Theatre System has an HDMI ARC connection, you can use any HDMI connection on the TV to connect. All HDMI connections on the TV can offer the Audio Return Channel (ARC) signal. But once you connected the Home Theatre System, the TV can only send the ARC signal to this HDMI connection.

With HDMI ARC, you do not need to connect the extra audio cable. The HDMI ARC connection combines both signals.

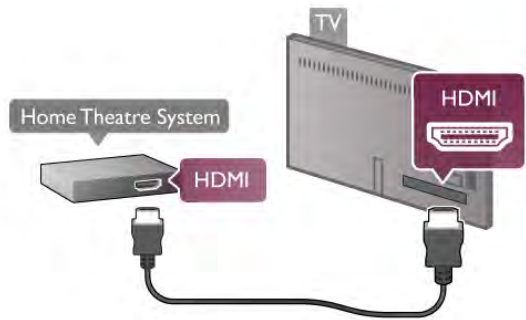

If the Home Theatre System has no HDMI ARC connection, add an optical audio cable to send the sound of the TV picture to the Home Theatre System.

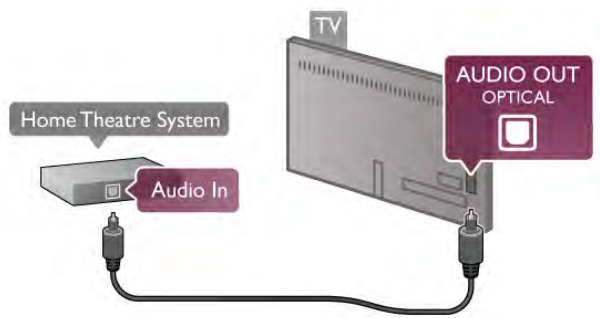

### Audio to video synchronisation (sync)

If the sound does not match the video on screen, you can set a delay on most DVD Home Theatre Systems to match the sound and video. A mismatch can be visible in scenes with people talking. When they finish sentences before their lips stop moving.

In **Help**, press **Menu** **List** and look up **Audio to video sync** for more information.

---

### Audio to video sync

With a Home Theatre System (HTS) connected to the TV, the picture on TV and the sound from the HTS should be synchronised. A mismatch can be visible in scenes with people talking - when they finish sentences before their lips stop moving or just the opposite.

### Automatic audio to video sync

With recent Philips Home Theatre Systems, the audio to video sync is automatically synchronised and always correct.

### Audio sync delay

For some Home Theatre Systems you might need to adjust the audio sync delay to synchronise the audio to video. On the HTS, increase the delay value until there is a match between picture and sound. A delay value of 180ms may be required. Read the user manual of the HTS.

With a delay value set up on the HTS, you need to switch off Audio Out delay on the TV. To switch off Audio Out delay, press **Home** and select **Setup** and press **OK**.

Select **TV settings** > **Sound** > **Audio Out delay**. Select **Off** and press **OK**.

### Audio Out Offset

If you cannot set a delay on the Home Theatre System, you can set the TV to sync the sound.

To synchronize the sound on the TV, press **Home** and select **Setup** and press **OK**.

Select **TV settings** > **Sound** > **Audio Out offset**. Use the slider bar to set the sound offset and press **OK**. The value set compensates the time necessary for the Home Theatre System to process the sound of the TV picture. You can set the offset in steps of 5ms. Maximum setting is -60ms. The Audio Out delay setting should be switched on.

### Audio Out Settings

#### Audio Out format

The standard setting for Audio Out format is **Multichannel**. Home Theatre Systems with multichannel sound capabilities (Dolby Digital, DTS® or similar) can receive a compressed multichannel sound signal from a TV channel or a connected disc player.

To set the Audio Out format, press **Home** and select **Setup** and press **OK**.

Select **TV settings** > **Sound** > **Audio Out format**.

If you have a Home Theatre System without any multichannel sound processing capabilities, select **Stereo**.

#### Audio Out levelling

Use the Audio Out levelling setting to level the volume (loudness) of the TV and the Home Theatre System when you switch over from one to another. Volume differences can be caused by differences in sound processing.

To level the difference, press **Home** and select **Setup** and press **OK**.

Select **TV settings** > **Sound** > **Audio Out levelling**.

If the volume difference is large, select **More**. If the volume difference is small, select **Less**.

Audio Out levelling affects both the Audio Out - Optical and HDMI-ARC sound signals.

## Blu-ray Disc Player

Use an HDMI cable to connect the Blu-ray Disc player to the TV.

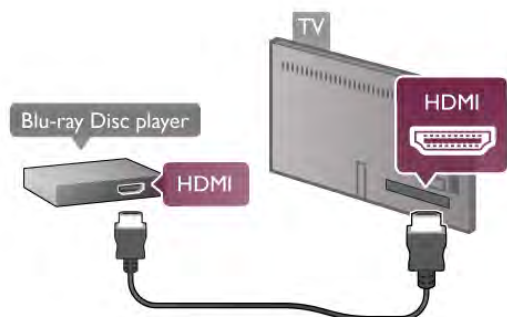

If the Blu-ray Disc player has EasyLink HDMI CEC, you can operate the player with the TV remote control.

In **Help**, press **Menu** **List** and look up **EasyLink HDMI CEC** for more information.

## DVD Player

Use an HDMI cable to connect the DVD player to the TV. Alternatively, you can use a SCART cable if the device has no HDMI connection.

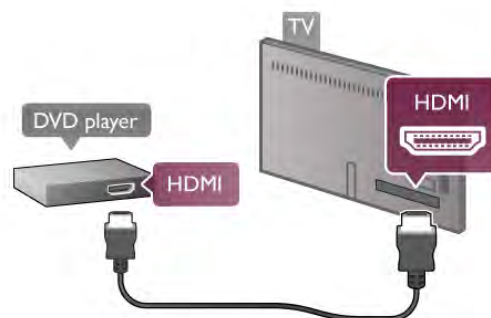

If the DVD player is connected with HDMI and has EasyLink HDMI CEC, you can operate the player with the TV remote control.

In **Help**, press **Menu** **List** and look up **EasyLink HDMI CEC** for more information.

## Game

Connect a game console to the side or back of the TV. You can use an HDMI, YPbPr or SCART connection. If your game console only has Video (CVBS) and Audio L/R output, use a Video Audio L/R to SCART adapter to connect to the SCART connection.

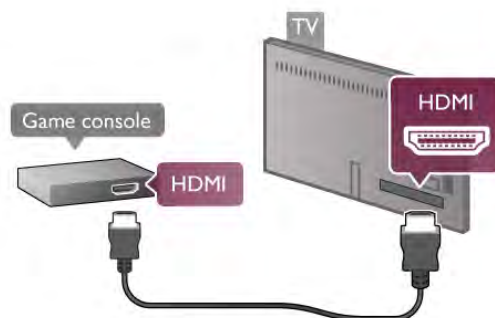

For best quality, use an HDMI cable to connect the game console to the side of the TV.

If the game console is connected with HDMI and has EasyLink HDMI CEC, you can operate the game console with the TV remote control.

Alternatively, use a SCART adapter (not supplied) to connect the game console to the TV.

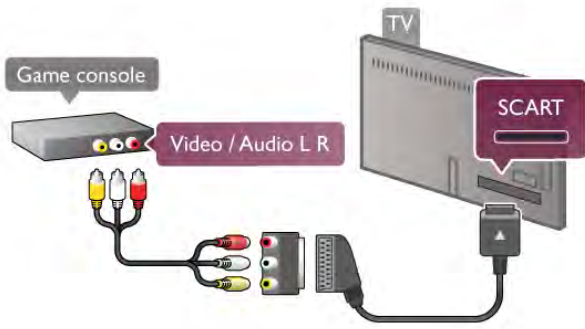

## USB Hard Drive

### What you need

If you connect a USB Hard Drive, you can pause or record a TV broadcast. The TV broadcast needs to be a digital broadcast (DVB broadcast or similar). Also, you can connect a USB Hard Drive to watch movies from an online video store (Video On Demand).

### To watch rental videos

If you are connected with the Internet, you can rent a movie from an online video store. Open **Smart TV** and start a rental video App from the **App gallery**.

To download a rental video, you can connect a 8GB USB flash drive but alternatively, you can use a USB Hard Drive. When installing the USB Hard Drive, you can select if you also want to use the USB Hard Drive for rental videos. Even when the rental video store uses video streaming, you might need the USB Hard Drive to store some video buffer.

### To pause

To pause a broadcast, you need a USB 2.0 compatible Hard Drive with a minimum of 32GB Hard Drive space and a minimum writing speed of 30MB/s.

### To record

To pause and record broadcasts, you need a Hard Drive with a minimum of 250GB Hard Drive space.

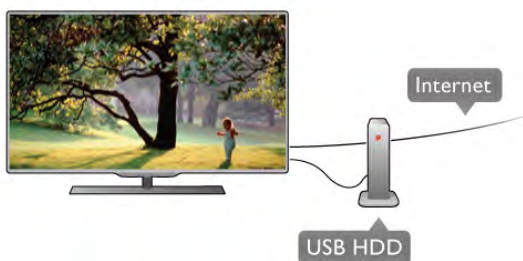

### TV guide

Before you decide to buy a USB Hard Drive to record, you can check if you can record digital TV channels in your country. Press **Guide** on the remote control. If there is a Record button on the TV guide page, you can record programmes from digital TV channels.

If the Record button is not available, check if the TV guide is updated from the Internet.

To check if the TV guide gets its data from the Internet, press **Home** and select **Setup** and press **OK**.

Select **TV settings** > **General settings** > **TV guide**. Select **From the Internet** and press **OK**.

In **Help**, press **Menu** **List** and look up **USB Hard Drive, Installation** to install a USB Hard Drive on this TV.

### Installation

Before you can pause or record a broadcast, you must connect and format a USB Hard Drive. If you want to record a broadcast with TV guide data from the Internet, you need to have the Internet connection installed on your TV before you install the USB Hard Drive.

**1** - Connect the USB Hard Drive to a **USB** connection on the back of the TV. You can use any USB connection on the TV but the connection next to HDMI 1 is the most practical one. Do not connect another USB device to the other USB ports when formatting.

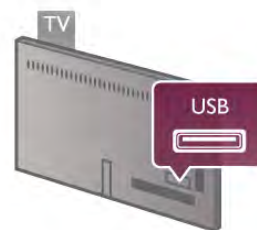

**2** - Switch on the USB Hard Drive and the TV.

**3** - When the TV is tuned to a digital TV channel, press **Pause** (Pause). Trying to pause will start the formatting. Formatting removes all files from the connected USB Hard Drive. Follow the instructions on screen.

When the USB Hard Drive is formatted, leave it connected permanently.

### Warning

The USB Hard Drive is formatted exclusively for this TV, you cannot use the stored recordings on another TV or PC. Do not copy or change recording files on the USB Hard Drive with any PC application. This will corrupt your recordings. When you format another USB Hard Drive, the content on the former will be lost. A USB Hard Drive installed on your TV will need reformatting for use with a computer.

In **Help**, press **Menu** **List** and look up **Pause TV** or **Recording** to pause or record TV channels.

## USB keyboard or mouse

### USB keyboard

Connect a USB keyboard (USB-HID type) to enter text on your TV.

You can connect a keyboard and a mouse to the TV.

Use the **USB** connection on the side of the TV to connect.



### Install the keyboard

To install the USB keyboard, switch on the TV and connect the USB keyboard to one of the **USB** connections on the side of the TV. When the TV detects the keyboard for the first time, you can select your keyboard lay-out and test your selection.

If you select a Cyrillic or Greek keyboard lay-out first, you can select a secondary Latin keyboard lay-out. To change the keyboard lay-out setting later on, press **Home** and select **Setup** and press **OK**. Select **TV settings > General settings > USB mouse and keyboard > Keyboard settings** and press **OK**.

### Keys for channel renaming

- Enter **↵** = OK
- Backspace **←** = delete character before cursor
- Arrow keys = navigate within a text field
- To switch between keyboard lay-outs, if a secondary lay-out is set, press the **Alt + Shift** keys simultaneously.

### Keys for Smart TV Apps and Internet pages

- **Tab** and **Shift Tab** = Next and Previous
- **Home** = scroll to the top of the page
- **End** = scroll to the bottom of the page
- **Page Up** = jump one page up
- **Page Down** = jump one page down
- **+** = zoom in one step
- **-** = zoom out one step
- **\*** = fit to width

In **Help**, press **≡ List** and look up **USB mouse**, to connect a USB mouse.

---

### USB mouse

You can connect a USB mouse (USB-HID type) to navigate pages on the Internet. On an Internet page, you can select and click on links more easily. The USB mouse cannot navigate in Smart TV App pages nor navigate in the TV menus.



### Install the mouse

Switch the TV on and connect the USB mouse to one of the **USB** connections on the side of the TV. You can also connect the USB mouse to a connected USB keyboard.

### Mouse clicks

- **Left click** = OK
- **Right click** = Back **↶**

You can use the scroll wheel to scroll pages up and down.

In **Help**, press **≡ List** and look up **USB keyboard**, to connect a USB keyboard.

---

### USB flash drive

You can view photos or play your music and videos from a connected USB flash drive.

Insert a USB flash drive into the **USB** connection on the left-hand side of the TV while the TV is switched on.

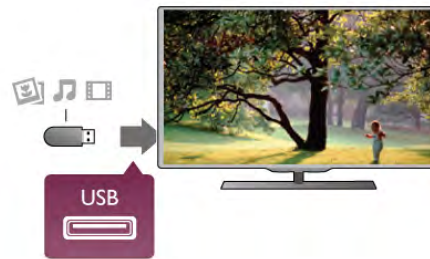

The TV detects the flash drive and opens a list showing its content.

If the contents list does not appear automatically, press **Source**, select **USB** and press **OK**.

To stop watching the USB flash drive content, press **TV** or select another activity.

To disconnect the USB flash drive, you can pull out the flash drive anytime.

In **Help**, press **≡ List** and look up **Videos, photos and music**, to watch or listen to content from an USB flash drive.

---

### Photo camera

To view photos stored on your digital photo camera, you can connect the camera directly to the TV.

Use the **USB** connection on the left side of the TV to connect. Switch on the camera after you made the connection.



If the contents list does not appear automatically, press **SOURCE**, select **USB** and press **OK**.  
Your camera might need to be set to transfer its content with PTP (Picture Transfer Protocol). Read the user manual of the digital photo camera.

In **Help**, press **List** and look up **Videos, photos and music** for more information on viewing photos.

## Camcorder

Connect a camcorder to the side or back of the TV. You can use an HDMI, YPbPr or SCART connection. If your camcorder only has Video (CVBS) and Audio L/R output, use a Video Audio L/R to SCART adapter to connect to the SCART connection.

For best quality, use an HDMI cable to connect the camcorder to the side of the TV.



Or use a SCART adapter to connect the camcorder to the TV.

## Computer

You can connect your computer to the TV and use the TV as a PC monitor.

### With VGA

Use a VGA cable to connect the computer to the **VGA** connector and add an audio L/R cable to connect the **VGA** Audio to **AUDIO IN - VGA/DVI** on the back of the TV.

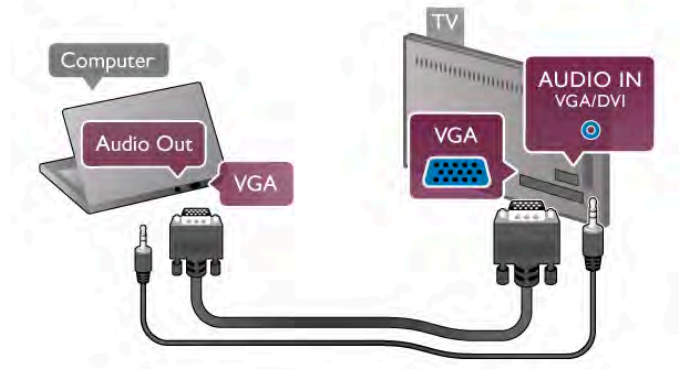

### With HDMI

Use an HDMI cable to connect the computer to the TV.

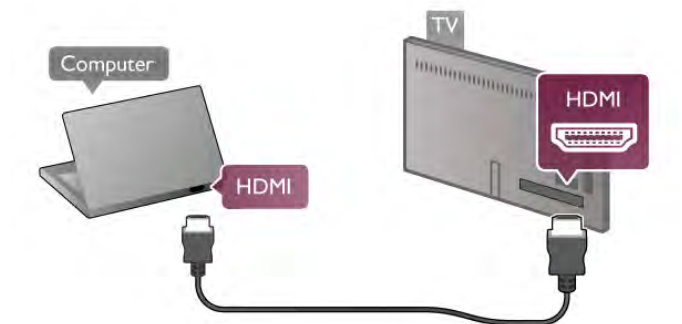

### With DVI to HDMI

Alternatively, you can use a DVI to HDMI adapter to connect the PC to **HDMI** and an audio L/R cable to **AUDIO IN - VGA/DVI** on the back of the TV.

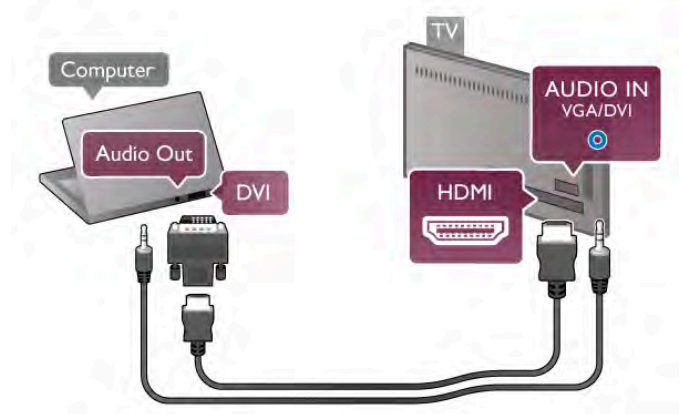

Ideal monitor setting



If your computer is added as a **Computer** type of device in the Source menu (list of connections), the TV is set to the ideal **Computer** setting automatically.

If you use your computer to watch movies or use it to play games, you might want to set the TV back to the ideal TV watching or gaming setting.

To set the TV to the ideal setting manually . . .

- 1 - Press **Home**, select **Setup** and press **OK**.
- 2 - Select **TV settings** > **Picture** > **Game or computer** and press **OK**.
- 3 - Select **Game** (for gaming) or select **Off** (for watching a movie) and press **OK**.
- 4 - Press **Back**, repeatedly if necessary, to close the menu. Remember to set the Game or computer setting back to **Computer** when you stop playing the game.

### Picture format - Unscaled

Additionally to the automatic settings, you can also set the Picture format to Unscaled - an expert pixel for pixel display mode (black bars may appear).

- 1 - Press **Options** and select **Options** in the menu bar.
- 2 - Select **Picture format** > **Unscaled** and press **OK**.

In **Help**, press **List** and look up **Display resolutions**, for an overview of the supported PC resolutions.

---

2.7

## Setup menu

In this **Help**, press **List** and look up the topic you need in the alphabetical list. Select the topic and press **OK** to open the Help page for more information.

---

2.8

## TV stand and wall mounting

### TV Stand

The foot of the TV stand has the TV loudspeakers built-in. The TV stand offers a larger speakerbox for optimum sound, compared to built in speakers in a thin TV display.

Always connect the cable of the foot to the TV for sound, connect the cable tightly. For best sound, avoid placing the foot on a thick carpet or cloth.



You can find the mounting instructions of the TV stand in the Quick Start Guide that came with the TV. In case you lost this guide, you can download the guide from [www.philips.com](http://www.philips.com) Use the product type number of the TV to look for the Quick Start Guide to download.

In **Help**, press **List** and look up **Wall mounting** to use the TV stand to mount the TV on a wall.

---

## Wall mounting

With the base and neck of the TV stand, you can also mount the TV to the wall.

Combine the base and neck to make a swivel mount or alternatively only use the base to mount the TV closer to the wall. Always connect the cable of the base to the TV for sound, connect the cable tightly.

### Wall mounting instructions

You can find the mounting instructions for wall mounting in the Quick Start Guide that came with the TV. In case you lost this guide, you can download the guide from [www.philips.com](http://www.philips.com) Use the product type number of the TV to look for the Quick Start Guide to download.

### Using an accessory TV wall mount

Your TV is also prepared for a VESA-compliant wall mount bracket (sold separately). Find the VESA code next to the TV type number.

- 40PFL7007 - VESA MIS-F 200,200,M6
- 46PFL7007 - VESA MIS-F 200,200,M6
- 55PFL7007 - VESA MIS-F 400,400,M6
- 40PFL8007 - VESA MIS-F 200,200,M6
- 46PFL8007 - VESA MIS-F 200,200,M6
- 55PFL8007 - VESA MIS-F 400,400,M6

### Preparation

Remove the 4 screws on the back of the TV that cover the VESA screw holes. Do not use these 4 screws to fix the accessory wall mount bracket.

To fix the bracket securely, use a screw length as shown in the drawing.

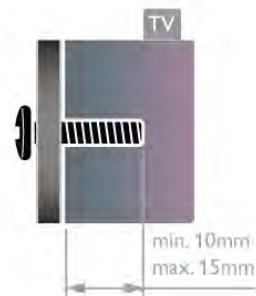

### Caution

Wall mounting the TV requires special skills and should only be performed by qualified personnel. The TV wall mounting should meet safety standards according to the TV's weight. Also read the safety precautions before positioning the TV.

TP Vision Netherlands B.V. bears no responsibility for improper mounting or any mounting that results in accident or injury.

---

2.9

## Safety and care

---

### Safety

Read and understand all safety instructions before you use the TV. If damage is caused by failure to follow instructions, the warranty does not apply.

#### Risk of electric shock or fire!

- Never expose the TV to rain or water. Never place liquid containers, such as vases, near the TV. If liquids are spilt on or into the TV, disconnect the TV from the power outlet immediately. Contact Consumer Care to have the TV checked before use.
- Never expose the TV, remote control or batteries to excessive heat. Never place them near burning candles, naked flames or other heat sources, including direct sunlight.
- Never insert objects into the ventilation slots or other openings on the TV.
- Never place heavy objects on the power cord.
- Avoid force coming onto power plugs. Loose power plugs can cause arcing or fire. Ensure that no strain is exerted on the power cord when you swivel the TV screen.
- To disconnect the TV from the mains power, the power plug of the TV must be disconnected. When disconnecting the power, always pull the power plug, never the cord. Ensure that you have full access to the power plug, power cord and outlet socket at all times.

#### Risk of injury or damage to the TV!

- Two people are required to lift and carry a TV that weighs more than 25 kg or 55 lbs.
- If you mount the TV on a stand, only use the supplied stand. Secure the stand to the TV tightly. Place the TV on a flat, level surface that can support the weight of the TV and the stand.
- When wall mounted, ensure that the wall mount can safely bear the weight of the TV set. TP Vision Netherlands B.V. bears no responsibility for improper wall mounting that results in accident, injury or damage.
- Parts of this product are made of glass. Handle with care to avoid injury or damage.

#### Risk of damage to the TV!

Before you connect the TV to the power outlet, ensure that the power voltage matches the value printed on the back of the TV. Never connect the TV to the power outlet if the voltage is different.

#### Risk of injury to children!

Follow these precautions to prevent the TV from toppling over and causing injury to children:

- Never place the TV on a surface covered by a cloth or other material that can be pulled away.
- Ensure that no part of the TV hangs over the edge of the mounting surface.
- Never place the TV on tall furniture, such as a bookcase, without anchoring both the furniture and TV to the wall or a suitable support.

- Teach children about the dangers of climbing on furniture to reach the TV.

#### Risk of swallowing batteries!

The remote control may contain coin-type batteries which can easily be swallowed by small children. Keep these batteries out of reach of children at all times.

#### Risk of overheating!

Never install the TV in a confined space. Always leave a space of at least 10 cm or 4 inches around the TV for ventilation. Ensure curtains or other objects never cover the ventilation slots on the TV.

#### Lightning storms

Disconnect the TV from the power outlet and antenna before lightning storms. During lightning storms, never touch any part of the TV, power cord or antenna cable.

#### Risk of hearing damage!

Avoid using earphones or headphones at high volumes or for prolonged periods of time.

#### Low temperatures

If the TV is transported in temperatures below 5°C or 41°F, unpack the TV and wait until the TV temperature reaches room temperature before connecting the TV to the power outlet.

---

### Screen care

- Never touch, push, rub or strike the screen with any object.
- Unplug the TV before cleaning.
- Clean the TV and frame with a soft damp cloth and wipe gently. Avoid touching the Ambilight LED's on the backside of the TV. Never use substances such as alcohol, chemicals or household cleaners on the TV.
- To avoid deformations and colour fading, wipe off water drops as quickly as possible.
- Avoid stationary images as much as possible. Stationary images are images that remain onscreen for extended periods of time. Stationary images include onscreen menus, black bars, time displays, etc. If you must use stationary images, reduce screen contrast and brightness to avoid screen damage.

---

### Temperature and humidity

In rare occasions, depending on temperature and humidity, minor condensation can occur on the inside of the TV glass front (on some models). To prevent this, do not expose the TV to direct sunlight, heat or extreme humidity. If condensation occurs, it will disappear spontaneously while the TV is playing for a few hours. The condensation moisture will not harm the TV or cause malfunction.

# TV

## Switch on

### Switch on and off

Make sure you plugged in the mains power on the back of the TV before you switch on the TV.

If the red indicator light is off, press the small key  on the right, on the back of the TV to put the TV on standby - the red indicator will light up.



With the TV on standby, press  on the remote control to switch the TV on. Alternatively, you can use the **CH+**, **CH-** and **Home** key to switch the TV on.



#### Quick start

To switch on the TV faster than usual, you can set the TV in **Quick start** mode.

In **Help**, press  **List** and look up **Quick start** for more information.

#### Switch to standby

To switch the TV to standby, press  on the remote control.

#### Switch off

To switch the TV off, press the small key  on the right of the TV on the back. There is no red indicator light. The TV is still connected to the mains power but consumes a minimum of energy. To switch off the TV completely, disconnect the power plug.

When disconnecting the power plug, always pull the power plug, never the cord. Ensure that you have full access to the power plug, power cord and outlet socket at all times.



## Quick start

With Quick start, the TV can start up faster than usual. When you switch the TV on from standby the TV picture already appears after a few seconds, if Quick start is activated.

The TV can remember your daily habit of watching TV. Some time before you usually switch on the TV, Quick start will activate automatically, allowing you to switch on quickly. Alternatively, you can select up to 3 fixed time frames a day during which the TV is ready to switch on quickly.

When you switch the TV back to standby, Quick start stays active until the set time frame ends.

#### Activate

To set the Quick start activation, press  and select  **Setup** and press **OK** to open the Setup menu. Select **TV settings** > **General settings** > **Quick start** > **Activation**. You can select Automatic or Manual.

#### - Automatic

Select **Automatic** to activate Quick start automatically. The TV remembers your watching habit and activates Quick start during these time frames. With Automatic, the TV can set up to 4 time frames of 1 hour.

#### - Manual

Select **Manual** to activate Quick start during 3 fixed time frames a day. As an example, you can set a time frame in the morning, one at noon and one in the evening. For each time frame, you can set the time span yourself.

If Quick start is set to Manual, you can also select a **Standby delay**. With Standby delay, you can set the TV to keep Quick start active for some time after you switched the TV to standby. You can set the delay up to 1 hour in steps of 15 minutes.

#### Specifics

The TV clock has to work properly to activate Quick start. Quick start activation cannot be longer than a 4 hour time frame.

Quick start increases the energy consumption during standby.

## Remote control

## Top

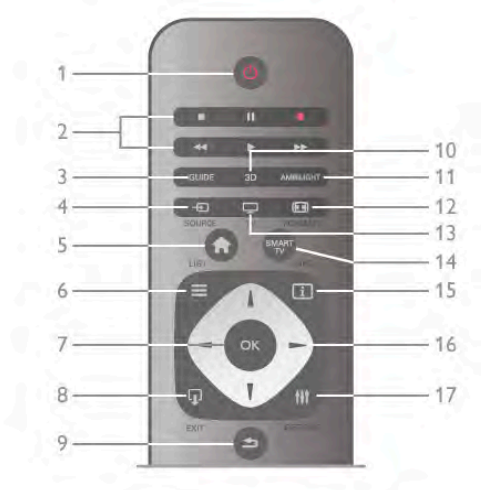

### 1 - Standby

To switch the TV on or back to standby.

**2 - Playback and record keys** • Play , to playback • Pause , to pause playback • Stop , to stop playback • Rewind , to rewind • Fast Forward , to wind fast forward • Record , to record now

### 3 - **GUIDE**

To open or close the TV guide.

### 4 - **SOURCE**

To open or close the list of connections.

### 5 - **Home**

To open or close the home menu.

### 6 - **LIST**

To open or close the channel list or your list of photos, music or videos.

### 7 - **OK** key

To confirm a selection.

### 8 - **EXIT**

To go back to your last chosen connected device, e.g. digital receiver.

### 9 - **Back**

To go back to the last chosen channel. To close a menu without changing a setting. To go back to the previous Text or Smart TV Internet page.

### 10 - **3D**

To open or close the 3D menu.

### 11 - **AMBILIGHT**

To switch Ambilight on or off and to switch Ambilight on in standby.

### 12 - **FORMAT**

To open or close the Format menu.

### 13 - **TV**

To switch to Watch TV.

### 14 - **SMART TV**

To open the Smart TV start page.

### 15 - **INFO**

To open or close Info.

### 16 - **Arrow keys**

To navigate up, down, left or right.

### 17 - **OPTIONS**

To open or close the Options menu.

## Bottom



### 1 - **CH-**, Channel -

To switch to the previous channel in the channel list, the previous page in Text or the previous chapter on a disc.

### 2 - **CH+**, Channel +

To switch to the next channel in the channel list, the next page in Text or the next chapter on a disc.

### 3 - **Volume -** and **+**

To adjust the volume level.

### 4 - **Colour keys**

Direct selection of options.

### 5 - **Number keys** and **text keypad**

To select a TV channel directly or to enter text.

### 6 - **SUBTITLE**

To switch subtitles on, off or on during mute.

### 7 - **TEXT**

To open or close Text.

### 8 - **Mute**

To mute the sound or to restore it.

## Keyboard

### Using the keyboard

With the keyboard on the back of the remote control, you can enter text in any text field on screen. Turn the keyboard facing upwards to activate the keyboard keys.

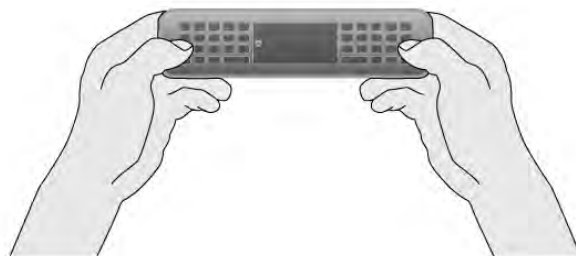

### Enter text

To enter text in a text field on screen, select the text field and start typing. Press **Enter** (1) to confirm the text.



### Shift

To type an uppercase character, press and hold the **⇧aA** (Shift) key (2) and type the uppercase character you need. If you only need 1 uppercase character in your text, press the **⇧aA** key just before typing the character you need. If you need to type several uppercase characters consecutively, you can hold the **⇧aA** key while typing or press the **⇧aA** key for 2 seconds to switch the keyboard in uppercase mode. Press the **⇧aA** key once to switch out of the uppercase mode again. If you do not press any character on the keyboard, the uppercase mode switches off automatically after 20 seconds. Also, if you press any other modifier key on the keyboard, like **Fn** (3) or the **␣** (4) key, you switch out of the uppercase mode.

### Alternative characters

To type an alternative character (the coloured characters on the keyboard) press and hold the **Fn** key (3) and type the alternative character you need. You can switch to or back out of the alternative character mode as you do for the uppercase mode.

### Special characters - ␣

Some characters have no key on the remote control keyboard. To enter special characters, you can open the onscreen keyboard. To open the onscreen keyboard, press **␣** (4). In the onscreen keyboard, you can navigate to the character you need. Switch the keyboard lay-out with the colour keys. Press **OK** to enter a character. The onscreen keyboard disappears when you press a character on the remote control keyboard. Alternatively, you can enter special characters with the remote control SMS/text keypad on the front of the remote control.

### Email and Internet

You can use the **Fn** key to enter the characters for email and Internet use, like @, # or www. and .com.

### Keyboard overview

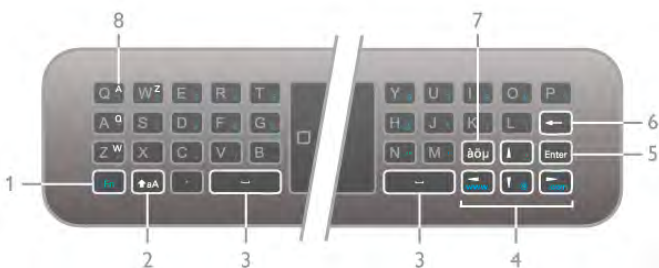

#### 1 - Fn key

Hold the **Fn** key to type an alternative, coloured character.

#### 2 - ⇧aA Shift

Hold the Shift key to type uppercase characters.

#### 3 - ␣ Spacebar key

#### 4 - Arrow keys

#### 5 - Enter

Press **Enter** to confirm the text you entered.

#### 6 - Backspace

Deletes the character in front of the text cursor.

#### 7 - ␣ Special character key

Press **␣** to open the onscreen keyboard to select a special character.

#### 8 - AZERTY character key

Character if the keyboard lay-out is set to **AZERTY**.

### Qwerty or Azerty

The standard layout of the remote control keyboard is **QWERTY**.

You can also set the keyboard layout to **AZERTY**. To change the keyboard layout, press **Home** and select **Setup** and press **OK** to open the Setup menu.

Select **TV settings > General settings > Remote control keyboard**.

Select **QWERTY** or **AZERTY**.

The **AZERTY** characters are indicated at the top right of the relevant keys.



### Pointer

#### About pointer

Instead of using the arrow keys to select items on screen (the up, down, left or right arrows), you can use the remote control pointer. When you move the remote control, the pointer - a small circle - will move along on screen. It's like using a mouse on a computer. The pointer can navigate Smart TV Apps\* and Internet pages on your TV.

#### Update your TV software

Before you can use pointer, the TV needs an update of its software. The new TV software with the pointer function will be available around the second half of 2012. If the TV is connected to the Internet, you will be notified when new TV software is ready to install. When the update for the pointer is done, the Smart TV start page will notify you when the remote control can use the pointer.

In **Help**, press **≡ List** and look up **Software, Internet update** for more information.

### USB mouse

With a connected USB mouse you can already use the pointer function on Internet pages.

\*Gradually Smart TV Apps will come available for use with the pointer.

---

### Using the pointer

When you open the Smart TV start page, the pointer is shown above the TV word mark in the middle of the TV screen.



- 1 - Position your thumb on the **OK** key of the remote control to activate the pointer.
- 2 - Move the remote control to move the pointer on screen.

When you hover the pointer over a link . . .

- 1 - The pointer changes size and gets a dot inside the circle.
- 2 - Press **OK** to open the link.

When you hover the pointer over a text field . . .

- 1 - The pointer changes size and gets an I-beam cursor inside the circle.
- 2 - Press **OK** to enter text.

Some Smart TV Apps might not support the use of the pointer. When the pointer is not available, you can use the arrow keys to navigate the screen.

### Switch off pointer

If you do not want to use the pointer, you can switch back to use the arrow keys to navigate.

To use the arrow keys on Smart TV and Internet pages . . .

- 1 - Press **≡ OPTIONS**, select the **Options** tab in the menu bar and select **Remote control navigation**.
- 2 - Select **Arrow keys**.

---

## IR Sensor

The remote control of the TV uses RF (radio frequency) to send its commands to the TV. With RF, you do not need to point the remote control at the TV.

However, the TV can also receive commands from a remote control that uses IR (infrared) to send commands. If you use such a remote control, always make sure you point the remote control at the infrared sensor on the front of the TV.



---

## Pairing

This remote control uses radio frequency (RF) to send its commands to the TV. Opposite to remote controls using infrared signals, with this remote control you can send commands without pointing at the TV.

With no need to point the remote control, using the keyboard on the back or sending commands from another room - changing the volume or switching channels - is easy. Additionally, the TV can notify you when the battery power of the remote control is low.

### Pairing the remote control

For the remote control to communicate with the TV, both TV and remote control should be paired with each other. Once paired, you cannot use the remote control to control another TV.

When you started the initial TV installation, the TV invited you to press the **OK** key, and by doing so, the pairing was done. When you switch off the TV, the pairing is stored. You can pair up to 5 remote controls with this TV.

### Repairing

You can pair another remote control with this TV.

The method to repair a remote control is different for a remote control already paired with another TV or for a remote control that is not paired yet.

- **The remote control is paired with another TV**

To pair, hold the Remote control close to the Philips logo (about 10cm) and press the **Red** and **Blue** key at the same time. A message will appear if pairing is successful.

- **The remote control is not paired yet**

To pair, hold the Remote control close to the Philips logo (about 10cm) and press **OK**. A message will appear if pairing is successful.

### For retail

To pair a new - not yet paired - TV with a remote control which is already paired with another TV, hold the Remote control close to the Philips logo (about 10cm) and press the **Red** and **Blue** key at the same time. A message will appear if pairing is successful.



---

## Batteries

The TV will notify you when the battery power of the remote control is low.

To replace the batteries, open the battery compartment at the back of the remote control.

- 1 - Use a toothpick or other small, blunt object and press the small, square shaped release button to open the lid.
- 2 - Replace the old batteries with 3 type AAA-LR03-1.5V batteries. Make sure the + and the - ends of the batteries line up correctly.
- 3 - Reposition the battery cover and press it until it clicks.



Remove the batteries if you are not using the remote control for a long time.

Dispose of batteries according to the end of use directives. In **Help**, press **≡ List** and look up **End of use** for more information.

---

## Cleaning

Your remote control is treated with a scratch-resistant coating.

To clean the remote control, use a soft damp cloth. Never use substances such as alcohol, chemicals or household cleaners on the TV or remote control.

---

3.3

## Watch TV

---

### Channels

#### Switch channels

To watch TV channels, press **TV**. The TV tunes to the TV channel you last watched.

Alternatively, press **Home** to open the Home menu and select **Watch TV** and press **OK**.

#### Switch channels

To switch channels, press **CH+** or **CH-**. If you know the channel number, type in the number with the number keys. Press **OK** after you entered the number to switch channel immediately.

To switch back to the previously tuned channel, press **↶**.

#### To switch to a channel from a channel list

While watching a TV channel, press **≡ LIST** to open the channel lists.

Select a list in the row of tabs.



In a channel list, navigate to a TV channel or radio station. With the highlight on its icon, press **OK** to switch to the TV channel or listen to the radio station.

The channel list can have several pages with channels. To view the next or previous page, press **CH-** or **CH+**.

To close the channel lists without switching channel, press **≡ LIST** again.

#### Radio channels

If digital broadcasting is available, digital radio stations are installed during installation. Switch to a radio channel just like you switch to a TV channel. A Cable (DVB-C) channel installation usually places radio stations from channel number 1001 onwards.

---

#### Options on channels

While watching a TV channel, depending on the type of channel (analogue or digital) you are watching or depending on the TV settings you made, some options are available.

#### Open the options

While watching a TV channel, press **≡ OPTIONS** and select the **Options** tab in the menu bar.



## Universal access

With Universal access switched on, you can set some options for hearing impaired and visually impaired people.

In **Help**, press **≡ List** and look up **Universal access** for more information.

## Video selection

Digital TV channels can offer multi video signals (multi-feed broadcasts), different camera viewpoints or angles of the same event or different programmes on one TV channel. The TV shows a message if any such TV channels are available.

## Subtitles

Switch **Subtitles on** or **Subtitles off** with this option. Select **On during mute** to show subtitles only when the sound is muted with **🔇**.

## Subtitle language

For digital broadcast, you can select an available subtitle language temporarily if none of your preferred languages are available.

In **Help**, press **≡ List** and look up **Subtitles** for more information.

## Audio languages

For digital broadcast, you can select an available audio language temporarily if none of your preferred languages are available.

In **Help**, press **≡ List** and look up **Audio languages** for more information.

## Dual I-II

If an audio signal contains two audio languages but one language - or both - has no language indication, this option is available.

## Common interface

If prepaid premium content is available from a CAM, you can set the provider settings with this option.

## HbbTV on this channel

You can block the HbbTV pages from a channel that offers HbbTV.

In **Help**, press **≡ List** and look up **HbbTV** for more information.

## Status

Select **Status** to view technical information on the channel (if it is analogue or digital) or a connected device you are watching.

---

## Channel lists

---

### The channel lists

In the channel lists, you can find all installed TV and radio channels.

Next to the channel list **All**, which holds all installed channels, you can set up a list of **Favourites**, view the installed **Radio** stations separately or discover the newly added channels in **New**.

### To switch to a channel from a channel list

While watching a TV channel, press **≡ LIST** to open the channel lists.

Select one of the channel lists.



In a channel list, navigate to a channel or radio station. With the highlight on its icon, press **OK** to switch to the channel or listen to the radio station.

The channel list can have several pages with channels. To view the next or previous page, press **CH-** or **CH+**.

To close the channel lists without switching channel, press **≡ LIST** again.

### Mark as favourite

In the channel list **All**, you can set any channel as a favourite channel.

Navigate to the channel in the list and press **Mark as favourite**. The channel is added to the Favourite channel list.

### Channel list options

According to the channel list on screen, press **≡ OPTIONS** to select the following options:

- Digital / Analogue
- Free / Scrambled
- Lock
- Unlock



### Channel logos

For most channels, the TV can show a channel logo. If you wish to hide these logos, you can switch them off.

To switch off **Channel logos** . . .

- 1 - Press **HOME**, select **Setup** and press **OK**.
- 2 - Select **TV settings** > **General settings** > **Channel logos** and press **OK**.
- 3 - Select **Off** and press **OK**.
- 4 - Press **EXIT**, repeatedly if necessary, to close the menu.

---

### Rename channels

You can rename channels in any of the channel lists.

- 1 - In a channel list, highlight the channel you want to rename.
- 2 - Press **Rename**.

### Enter text

To enter text, select the text entry field with the arrow keys.



Use the remote control keypad as you do for SMS/text messaging to enter a character. The moment you start typing the on screen keyboard appears. You can select lowercase, uppercase, special characters and backspace with the colour keys.

Press **↵** to delete a character.

Select **Done** to end Rename.



Alternatively, if your remote control has a keyboard on the back, you can use that keyboard.

In **Help**, press **≡ List** and look up **Remote control keyboard** for more information.

---

### Reorder channels

You can reorder -reposition- channels in the Favourite channel list.

In **Help**, press **≡ List** and look up **Favourite channels** for more information.

---

### Favourite channels

You can create a favourite channel list that only holds the channels you want to watch. With the Favourite channel list selected, you will only see your favourite channels when you switch through channels.

#### Create your Favourite channel list

**1** - While watching a TV channel, press **≡ LIST** to open the channel lists.

**2** - Select **Favourites**.

**3** - If the list is empty, the TV asks you to start adding channels right now. Press **OK**.

**4** - Use the arrow keys to select a channel and press **OK** to make that channel a favourite channel. The order in which channels appear in the favourite list depends on the sequence in which you add them.

#### Add or remove favourites

To add or remove favourite channels from the Favourite channel list, open the list and press **≡ OPTIONS**, select **Add / remove favourites** and press **OK**.

Use the arrow keys to select a channel and press **OK** to add or remove it from the favourites list.

#### Reorder

You can reorder -reposition- channels in the Favourite channels list.

**1** - In the channel list **Favourites**, highlight the channel you want to reposition.

**2** - Press **■ Move**.

**3** - With the arrow keys, reposition the channel where you want it. Alternatively, you can enter the new position directly with the number keys.

**4** - Press **OK** to confirm the position. Or, to cancel the repositioning, press **■ Cancel**.

You can highlight another channel and do the same.

#### Add or remove favourites in other channel lists

You can mark channels and radio stations as favourites from the **All**, **Radio** and **New** channel list.

In these lists, highlight a channel you want to add to the favourite list and press **■ Mark as favourite**. The channel is marked with a star **★** and added to the Favourite channel list. To unmark a favourite channel, highlight the channel in any channel list and press **■ Unmark as favourite**. The channel is removed from the Favourite channels list.



---

### Child lock

To prevent children from watching a channel or a programme, you can lock channels or lock age-rated programmes.

#### Lock a channel

You can lock a channel to prevent children from watching it. To watch a locked channel you need to enter the Child lock code. To lock a channel, while watching a TV channel, press **≡ LIST** to open the **Channel lists**. In any list, select the channel you want to lock, press **≡ OPTIONS** and select **Lock channel**. In a channel list, a locked channel is marked with a lock **🔒**.

To unlock a channel, select the locked channel in the channel list and select the **Unlock channel** option. You will need to enter the Child lock code.

You cannot lock programmes from connected devices.

#### Parental rating

Some digital broadcasters have rated their programmes. When the rating is equal or higher than the rating you have set for your child's age, the programme will be locked.

To watch a locked programme you must enter the child lock code. The parental age rating is set for all channels.

#### Set an age rating

Press **🏠** and select **⚙️ Setup** and press **OK**.

Select **Channel settings > Child lock > Parental rating**.

To select an age rating, you must first enter your 4-digit child lock code. If no child lock code is set, you can set the code now.

When the code is entered, you can select the age rating. When the rating of a programme is equal or higher than the rating you have set for your child's age, the programme will be locked. The TV will ask for the code to unlock the programme. For some operators, the TV only locks programmes with a higher rating.

## Change code

To change the current Child lock code, press **Home**, select **Setup** and press **OK**.

Select **Channel settings** > **Child lock** > **Change code**.

Enter the current code and then enter the new code twice.

The new code is set.

## Forgotten your code?

If you have forgotten your code to unlock, call Consumer Care in your country. Find the telephone number on the documentation that came with the TV or go to [www.philips.com/support](http://www.philips.com/support).

---

## Channel installation

---

### Update channels

---

### Automatic update

If you receive digital channels, you can set the TV to automatically update the list with new channels. Alternatively, you can start a channel update yourself.

#### Automatic channel update

Once a day, at 6 AM, the TV updates the channels and stores new channels. New channels are stored in the All channels list but also in the New channels list. Empty channels are removed.

If new channels are found or if channels are updated or removed, a message is shown at TV start up. The TV must be in standby to automatically update channels.

To switch off the message at start up, press **Home**, select **Setup** and press **OK**.

Select **Channel settings** and press **OK**.

Select **Channel installation** > **Channel update message** > **Off**.

To switch off the Automatic channel update, press **Home**, select **Setup** and press **OK**.

Select **Channel settings** and press **OK**. Select **Channel installation** > **Automatic channel update** > **Off**.

#### Start an update

To start an update yourself, press **Home**, select **Setup** and press **OK**.

Select **Search for channels** and press **OK**.

Select **Update channels** and follow the instructions on screen.

The update may take a few minutes.

In certain countries, the Automatic channel update is done while watching TV or any moment when the TV is in standby.

---

## New channels

New channels added with the automatic channel update are easy to find in the channel list **New**. The same new channels are also stored in the **All** or **Radio** channel list.

New channels are kept in the channel list New as long as you don't mark them as a favourite or tune to them.

In **Help**, press **Menu** **List** and look up **Favourite channels** for marking channels as favourites.

---

## Reinstall channels

You can search for and reinstall channels and leave all other TV settings untouched. Alternatively, you can do a full new TV installation.

If a child lock code is set, you will need to enter this code before you can reinstall channels.

### Reinstall channels

To reinstall the channels only . . .

**1** - Press **Home**, select **Setup** and press **OK**.

**2** - Select **Search for channels** > **Reinstall channels** and press **OK**.

**3** - Select **Antenna (DVB-T)** or **Cable (DVB-C)**. The channel search may take a few minutes. Follow the instructions on screen.

### Full installation

To redo a full TV installation . . .

**1** - Press **Home**, select **Setup** and press **OK**.

**2** - Select **TV settings** > **Reinstall TV** and press **OK**. The installation may take a few minutes. Follow the instructions on screen.

### Factory settings

Factory settings sets the TV back to the original TV settings for picture, sound and Ambilight.

To switch back to the original Factory settings . . .

**1** - Press **Home**, select **Setup** and press **OK**.

**2** - Select **TV settings** > **General settings** > **Factory settings** and press **OK**.

**3** - Press **OK** to confirm.

**4** - Press **Back**, repeatedly if necessary, to close the menu.

---

## Channel list copy

---

### Introduction

Channel list copy is intended for dealers and expert users.

With **Channel list copy**, you can copy the channels installed on one TV onto another Philips TV of the same range. With Channel list copy, you avoid the time-consuming channel search by uploading a predefined channel list on a TV. The small file you copy fits every USB memory device.

### Conditions

- Both TVs are from the same year range.
- Both TVs have the same product type suffix for DVB (H, K, M, T or D/00) in their type number and have the TV installed for the same country.
- Both TVs have the same hardware type. Check the hardware type on the TV type plate on the back of the TV. Typically noted as Q . . . LA
- Both TVs have compatible software versions. When you upload, an on-screen message will warn you if software versions are not compatible.

### Current version

You can check the current version of the TV software with **Current version.**

---

## Copy channel list

### Copy a channel list

- 1 - Switch on the TV which has its channels installed. Plug in a USB memory device.
- 2 - Press **⏠**, select **⚙️ Setup** and press **OK**.
- 3 - Select **TV settings > General settings > Channel list copy > Copy to USB** and press **OK**. To copy the channel list from this TV, you might be asked to enter the Child lock code you entered during the installation.
- 4 - When copying is done, unplug the USB memory device.

Now you can upload the copied channel list onto another Philips TV.

---

## Upload channel list

### Upload a copied channel list

Depending on whether your TV is already installed or not, you must use a different way to upload a channel list.

#### To a TV that is not yet installed

- 1 - Plug in the power plug to start the installation and select language and country. You can skip Search for channels. Finish the installation.
- 2 - Plug in the USB memory device that holds the channel list of the other TV.
- 3 - To start the channel list upload, press **⏠**, select **⚙️ Setup** and press **OK**.
- 4 - Select **TV settings > General settings > Channel list copy > Copy to TV** and press **OK**. You might be asked to enter the Child lock code of this TV.
- 5 - The TV notifies you if the channel list is copied to the TV successfully. Unplug the USB memory device.

#### To an already installed TV

- 1 - Verify the country setting of the TV. (To verify this setting, press **⏠**, select **⚙️ Setup** and press **OK**. Select **Search for channels > Reinstall channels** and press **OK**. Press **➡** and later **Cancel** to leave the Search for channels.)  
If the country is correct continue with step 2.  
If the country is not correct, you need to start a reinstallation. To start the reinstallation, press **⏠**, select **⚙️ Setup** and press **OK**. Select **Search for channels > Reinstall channels > OK**. Select the correct country and skip the Search for channels. Finish the installation. When done, return to step 2.
- 2 - Plug in the USB memory device that holds the channel list of the other TV.
- 3 - To start the channel list upload, press **⏠**, select **⚙️ Setup** and press **OK**.
- 4 - Select **TV settings > General settings > Channel list copy > Copy to TV** and press **OK**. You might be asked to enter the Child lock code of this TV.
- 5 - The TV notifies you if the channel list is copied to the TV successfully. Unplug the USB memory device.

---

## DVB-T or DVB-C

If both DVB-T and DVB-C reception is available in your country and if this TV is ready to receive DVB-T and DVB-C for your country, you have selected one or the other during the channel installation.

If you want to change the DVB setting to start a new channel installation, press **⏠**, select **⚙️ Setup** and press **OK**. Select **Channel settings** and press **OK**. Select **Channel installation > Antenna connection > Antenna or Cable (DVB-C)** and press **OK**. Select the DVB setting you want.

### DVB-C channel installation

For ease of use, all DVB-C settings are set to automatic. If your DVB-C provider gave you specific DVB-C values, the network ID or network frequency, enter these values when the TV asks for them during installation.

It might be necessary to adjust the scanning (full or quick scan) or enter a specific symbol rate in the **Settings** menu while installing. To set a **Symbol rate**, first set the Symbol rate to **Manual**.

### Channel number conflicts

In some countries, different TV channels (broadcasters) might have the same channel number. While installing, the TV shows the list with channel number conflicts. You need to select which TV channel you want to install on a channel number with multiple TV channels.

### DVB-T + DVB-C

If you can use a DVB-T antenna input but also a DVB-C input, you can set up your TV for both DVB-T and DVB-C. Install one system followed by the other with the necessary settings. Once each system is installed, you need to switch the antenna input signal on the **Antenna** connection on the back of the TV and set the TV in the appropriate system to view the installed channels on TV.

To select the DVB-T or DVB-C setting, see above.

---

## Reception quality

If you receive digital channels, you can check the quality and signal strength of a channel.

If you have your own antenna, you can reposition the antenna to try and improve the reception.

To check the reception quality of a digital channel, switch to the channel.

Press **⏠**, select **⚙️ Setup** and press **OK**. Select **Channel settings** and press **OK**. Select **Channel installation > Digital : reception test** and press **OK**.

The digital frequency is shown for this channel. If the reception is poor, you can reposition your antenna. To check the signal quality of this frequency again, select **Search** and press **OK**. To enter a specific digital frequency yourself, use the remote control digit keys. Alternatively, select the frequency, position the arrows on a number with **◀** and **▶** and change the number with **▲** and **▼**. To check the frequency, select **Search** and press **OK**.

If you use DVB-C to receive channels, the options **Symbol rate mode** and **Predefined symbol rates** are available. For Symbol rate mode, select **Automatic**, unless your cable provider gave you a specific symbol rate value. To enter the symbol rate value, use the number keys.

---

## Manual installation

Analogue TV channels can be manually installed, channel by channel.

To install analogue channels manually, press **HOME**, select **Setup** and press **OK**.

Select **Channel settings** and press **OK**.

Select **Channel installation** > **Analogue : manual installation** and press **OK**.

### 1 - System

To set up the TV system, select **System** and press **OK**.

Select your country or the part of the world where you are now.

### 2 - Find channel

To find a channel, select **Find channel** and press **OK**. Select **Search** and press **OK**. You can also enter a frequency yourself. If the reception is poor, press **Search** again. If you want to store the channel, select **Done** and press **OK**.

### 3 - Fine tune

To fine tune a channel, select **Fine tune** and press **OK**. You can fine tune the channel with **▲** or **▼**.

If you want to store the channel found, select **Done** and press **OK**.

### 4 - Store

You can store the channel on the current channel number or as a new channel number.

Select **Store current channel** or **Store as new channel**.

You can redo these steps until you found all available analogue TV channels.

---

## Picture format

If black bars appear on top and bottom or on both sides of the picture, you can adjust the picture format to a format that fills the screen.

While watching a TV channel, press **FORMAT** to open the **Picture format** menu.

Select a format from the list and press **OK**.

### Picture formats

The following formats are available according to the picture on screen:

- **Auto fill**

Automatically enlarges the picture to fill the screen. Picture distortion is minimal, subtitles remain visible. Not suitable for PC input. Some extreme picture formats can still show black bars.

- **Auto zoom**

Automatically zooms in the picture to fill the screen as much as possible without distortion. Black bars may be visible. Not suitable for PC input.

- **Super zoom**

Removes the black bars on the side of 4:3 broadcasts. The picture is adjusted to fit the screen.

- **Movie expand 16:9**

Scales the picture to a 16:9 format.

- **Wide screen**

Stretches the picture to a 16:9 format.

- **Unscaled**

Expert mode for HD or PC input. Pixel for pixel display. Black bars may appear with pictures from a computer.

---

## Text

### Text pages

#### Open Text

To open Text while you are watching TV channels, press **TEXT**.

To close Text, press **TEXT** again.



#### Select a Text page

To select a page ...

- Enter the page number with the number keys.
- Press **◀** or **▶**.
- Press **▲** or **▼**.
- Press a colour key to select a colour-coded subject at the bottom of the screen.

#### Text sub-pages

A Text page number can hold several subpages. The subpage numbers are shown on a bar next to the main page number.

To select a subpage, press **◀** or **▶**.

#### T.O.P. Text pages

Some broadcasters offer T.O.P. Text.

To open T.O.P. Text pages within Text, press **OPTIONS** and select **T.O.P. overview**.

#### Search Text

You can select a word and scan Text for all occurrences of this word.

Open a Text page and press **OK**.

Select a word or number with the arrow keys.

Now press **OK** again to jump immediately to the next occurrence of this word or number.

Press **OK** again to jump to the subsequent occurrence.

To stop the search, press **▲** until nothing is selected.

#### Text from a connected device

Some connected devices that receive TV channels can also offer Text.

To open Text from a connected device, press **▲**, select the device and press **OK**.

While watching a channel on the device, press **≡** **OPTIONS**, select Show device keys and select the **≡** key and press **OK**. Press **➔** to hide the device keys.

To close Text, press **➔** again.

### Digital Text (UK only)

Some digital TV broadcasters offer dedicated Digital Text or interactive TV on their digital TV channels. This includes normal Text using the number, colour and arrow keys to select and navigate.

To close Digital Text, press **➔**.

---

### Text options

In Text, press **≡** **OPTIONS** to select the following:

- Freeze page
- Dual screen
- T.O.P. overview
- Enlarge
- Reveal
- Cycle subpages
- Language

#### Freeze page

To stop the automatic rotation of subpages, press **≡** **OPTIONS** and select **Freeze page**.

#### Dual screen / Full screen

To show the TV channel and Text alongside each other, press **≡** **OPTIONS** and select **Dual screen**.

Select **Full screen** to switch back to full screen view.

#### T.O.P. overview

To open T.O.P. Text, press **≡** **OPTIONS** and select **T.O.P. overview**.

#### Enlarge

To enlarge the Text page for more comfortable reading, press **≡** **OPTIONS** and select **Enlarge**. To scroll down the page, press **▼** or **▲**.

#### Reveal

To unhide hidden information on a page, press **≡** **OPTIONS** and select **Reveal**.

#### Cycle subpages

To cycle subpages when these are available, press **≡** **OPTIONS** and select **Cycle subpages**.

#### Language

To switch the group of characters that Text uses to display correctly, press **≡** **OPTIONS** and select **Language**.

---

### Text setup

#### Text language

Some digital TV broadcasters have several Text languages available.

To set your primary and secondary Text language, press **▲**, select **⚙️ Setup** and press **OK**.

Select **Channel settings** and select **Primary** or **Secondary Text** and select your preferred Text languages.

### Text 2.5

If available, Text 2.5 offers more colours and better graphics. Text 2.5 is activated as a standard factory setting.

To switch it off, press **▲**, select **⚙️ Setup** and press **OK**. Select **TV settings** > **Preferences** > **Text 2.5**.

---

## Interactive TV

### What is iTV?

With interactive TV, some digital broadcasters combine their normal TV programme with information or entertainment pages. On some pages, you can respond to a programme or vote, do online shopping or pay for a video-on-demand programme.

### HbbTV, MHEG, . . .

Broadcasters use various interactive TV systems : HbbTV (Hybrid Broadcast Broadband TV) or iTV (Interactive TV - MHEG). Interactive TV is sometimes referred to as Digital Text or Red button. But each system is distinct. Visit the broadcasters Internet website for more information.

### What you need

Interactive TV is only available on digital TV channels. To enjoy the full benefits of Interactive TV, you need a high-speed (broadband) Internet connection to the TV.

---

### iTV pages

#### Open iTV pages

Most channels that offer HbbTV or iTV invite you to press the **■** (red) key or **OK** key to open their interactive programme.

#### Navigate iTV pages

You can use the arrow and colour keys, the number keys and the **➔** key to navigate the iTV pages. You can use the **▶** (Play), **⏸** (Pause) and **■** (Stop) keys to watch videos within iTV pages.

#### Digital Text (UK only)

To open Digital Text, press **TEXT**. To close, press **➔**.

#### Close iTV pages

Most iTV pages inform you which key to use to close. To force an iTV page to close, switch to the next TV channel and switch back.

---

3.4

## TV guide

---

### Open TV Guide

With the TV guide you can view a list of the current and scheduled TV programmes of your channels\*.

## Open TV guide

To open the TV guide, press **GUIDE**.

Press **GUIDE** again to close.



The first time you open the TV guide, the TV scans all TV channels for programme information. This may take several minutes. TV guide data is stored in the TV.

## Switch to a programme

From the TV guide, you can switch to a current programme.

To select a programme, use the arrow keys to highlight the programme name.

Navigate to the right to view programmes scheduled later that day.

To switch to the programme (channel), select the programme and press **OK**.

## View programme details

To call up the details of the selected programme, press **INFO**.

## Change day

The TV guide can show scheduled programmes for the upcoming days (maximum up to 8 days).

To view the schedule of one of the next days, press **CH+**.

Press **CH-** to go back to the previous day.

Alternatively, you can press **OPTIONS** and select **Change day**.

Select **Previous day**, **Today** or **Next day** and press **OK**, to select the day of the schedule.

If the TV guide information comes from the Internet, press **Select day**.

## Set a reminder

If the TV guide data comes from the broadcaster, you can set reminders that alert you of the start of a programme with a message on screen.

To set a reminder, select the programme in the schedule and press the colour key of **Set reminder**. The programme is marked with a clock **🕒**.

To cancel the reminder, press the colour key of **Clear reminder**.

To view a list of all reminders you have set, press the colour key of **Scheduled reminders**.

## Search by genre

If the information is available, you can look up scheduled programmes by genre like movies, sports, etc.

To search for programmes by genre, press **OPTIONS** and select **Search by genre**.

Select a genre and press **OK**. A list with the found programmes appears.

## Recording

If you connect a USB Hard Drive to the TV, you can make a recording.

Use the TV guide to make a scheduled recording.

In **Help**, press **List** and look up **Recording** for more information.

\* Depending on where the TV guide information (data) is coming from, analogue and digital channels or only digital channels are shown. Not all channels offer TV guide information.

---

## Receiving TV guide info

The TV guide receives information (data) from broadcasters or from the Internet. In some regions and for some channels, TV guide information might not be available.

As long as you did not connect the TV to the Internet, the information comes from the broadcaster.

The moment the TV is connected to the Internet, the TV switches to information from the Internet.

If TV guide information comes from the Internet, the TV guide can also list analogue channels next to the digital channels. In the TV guide menu, you can view the current channel you are watching in a small screen. With the TV guide from the Internet, you cannot set reminders.

## Set the TV guide information

If the TV is connected to the Internet, you can set the TV to receive the TV guide information from the broadcaster.

To set the TV guide information, press **Home**, select **Setup** and press **OK**.

Select **TV settings** > **General settings** > **TV guide**.

Select **From the broadcaster** or **From the Internet**.

---

3.5

## Switch to devices

---

### Source list

In the list of connections - the Source menu - you can find the devices connected to the TV.

From this Source menu, you can switch to a device.

### Source menu

To open the Source menu, press **SOURCE**.

To switch to a connected device, select the device with the arrows **◀** (left) or **▶** (right) and press **OK**.

For some devices (HDMI-CEC devices), you can select an activity directly in the list underneath the device icon.

Select the device and select an activity and press **OK**.

To close the Source menu without switching to a device, press **Source** again.



### Automatic detection

When you connect a new device to the TV, the device is detected automatically and put in the Source menu. The device is shown as an icon (the device type) and has a name. If the device type does not correspond with the device, e.g. the TV says it is a player but it is not, you can change the type. To change the type of the device, press **Device type** and select a type that fits the device and press **OK**. If the name does not fit the device or you want to give the device a name of your own, press **Rename**. Use the remote control keypad to enter a new name.

An appropriate device type helps you in using the device. The device type determines picture and sound styles, resolution values, specific settings or the position within the Source menu.

When you connect a new device to the TV, the icon of the device jumps to the front of the Source menu.

If the TV does not detect the device automatically, select the connection where you connected the device and adjust the Device type and name.

### Original name and icon

To restore the device icon to its original name and type icon, press **OPTIONS**, select the **Options** tab in the menu bar and select **Original name and icon** and press **OK**.

### Scan connections

To rescan all TV connections and update the Source menu, press **OPTIONS**, select the **Options** tab in the menu bar, select **Scan connections** and press **OK**.

## From standby

With the TV in standby, you can switch on a connected device with your TV remote control.

### Play

To switch on both disc player and TV from standby and start playing the disc or programme immediately, press **▶** (play) on the TV remote control.

The device should be connected with an HDMI cable and both TV and device must have HDMI CEC switched on.



## Home Theatre System

You can switch on your Home Theatre System to listen to an audio disc or a radio channel and leave the TV in standby. To only switch on the HTS, with the TV in standby, press **SOURCE** on the TV remote control.



## EasyLink

With **EasyLink** you can operate a connected device with the TV remote control. EasyLink uses HDMI CEC to communicate with the connected devices. Devices must support HDMI CEC and must be connected with an HDMI connection.

In **Help**, press **List** and look up **EasyLink** for more information.

3.6

## Subtitles and languages

### Subtitles

#### Switch subtitles on

To open the Subtitle menu, press **SUBTITLE**.

You can switch subtitles **On** or **Off**.

To show subtitles when the broadcasted programme is not in your language - the language you set for the TV, select **Automatic**. Also, this setting will show subtitles when you mute the sound with **MUTE**.

For analogue channels, subtitles must be made available in **Text**.



#### Subtitles for analogue channels

For analogue channels, you need to make subtitles available for each channel manually.

**1** - Switch to a channel and press **Text** to open Text.

**2** - Enter the page number for subtitles, usually 888.

**3** - Press **Text** again to close Text.

If you select **On** in the Subtitle menu when watching this analogue channel, subtitles will be shown if available.

To know if a channel is analogue or digital, switch to the channel and open **Status** in the **Options** menu.

#### Subtitles for digital channels

There is no need to set subtitles in Text for digital channels. Digital channels can offer several subtitle languages for a programme. You can set a preferred primary and secondary subtitle language. If subtitles in one of these languages are available, the TV will show them. If none of the preferred subtitle languages are available, you can select another subtitle language which is available.

To set the primary and secondary subtitle language . . .

- 1 - Press **HOME**, select **Setup** and press **OK**.
- 2 - Select **Channel settings** and select **Languages** > **Primary subtitles** or **Secondary subtitles** and press **OK**.
- 3 - Select a language and press **OK**.
- 4 - Press **RIGHT**, repeatedly if necessary, to close the menu.

To select a subtitle language when none of your preferred languages is available . . .

- 1 - Press **LIST** **OPTIONS**
- 2 - Select **Subtitle language** and select a language you want temporarily and press **OK**.

---

## Audio language

Digital TV channels can broadcast audio with several spoken languages for a programme. You can set a preferred primary and secondary audio language. If audio in one of these languages is available, the TV will switch to this audio. If none of the preferred audio languages is available, you can select another audio language which is available.

To set the primary and secondary audio language . . .

- 1 - Press **HOME**, select **Setup** and press **OK**.
- 2 - Select **Channel settings** and select **Languages** > **Primary audio** or **Secondary audio** and press **OK**.
- 3 - Select a language and press **OK**.
- 4 - Press **RIGHT**, repeatedly if necessary, to close the menu.

To select an audio language when none of your preferred audio language is available . . .

- 1 - Press **LIST** **OPTIONS**
- 2 - Select **Audio language** and select an audio language you want temporarily and press **OK**.



### Original language

If the digital channel holds the original language of a programme or movie, you can set the TV to automatically switch to that audio language. Set Original language to On to watch a dubbed movie in its original language (if the original language is available).

To set **Original language** . . .

- 1 - Press **HOME**, select **Setup** and press **OK**.
- 2 - Select **Channel settings** and select **Languages** > **Original language** and press **OK**.
- 3 - Select **On** or **Off** and press **OK**.

4 - Press **RIGHT**, repeatedly if necessary, to close the menu.

### Audio languages for the hearing and visually impaired

Some digital TV channels broadcast special audio and subtitles adapted for people who are hearing or visually impaired. In **Help**, press **LIST** and look up **Universal access** for more information.

---

## Menu language

To change the language of the TV menus and messages . . .

- 1 - Press **HOME**, select **Setup** and press **OK**.
- 2 - Select **TV settings** > **General settings** > **Menu language** and press **OK**.
- 3 - Select the language you want and press **OK**.
- 4 - Press **RIGHT**, repeatedly if necessary, to close the menu.

---

3.7

## Timers and clock

### Sleeptimer

With the sleep timer, you can set the TV to switch to standby automatically after a specified time.

To set the sleep timer, press **HOME**, select **Setup** and press **OK**. Select **TV settings** > **General settings** > **Sleep timer**. With the slider bar you can set the time up to 180 minutes in increments of 5 minutes. If set to 0 minutes, the sleep timer is switched off.

You can always switch off your TV earlier or reset the time during the countdown.

---

### Clock

To know what time it is, press **GUIDE** to find the time in the TV guide.

In some countries, digital broadcasts do not send UTC - Coordinated Universal Time information. The daylight saving change might be ignored and the TV might show an incorrect time.

To correct the TV clock, press **HOME**, select **Setup** and press **OK**.

Select **TV settings** > **General settings** > **Clock** and select **Country dependent**.

Select **Daylight saving** and select the appropriate setting. To set the time and date manually, select **Manual**. Then select **Time** or **Date**.

When you record programmes with **Smart TV, Recording**, we recommend not to change the time and date manually.



---

## Switch off timer

If you do not press a key on the remote control during a 4 hour period, or if the TV receives no input signal and receives no remote control commands for 10 minutes, the TV switches off automatically to save energy.

If you use the TV as a monitor or use a digital receiver to watch TV (a Set-top box - STB) and you do not use the remote control of the TV, you should deactivate the automatic switch off.

To deactivate, press **Home**, select **Setup** and press **OK**. Select **TV settings > General settings > Switch off timer** and set the slider bar to **0**.

In **Help**, press **≡ List** and look up **Saving energy** for more information on environmentally friendly TV settings.

---

3.8

## Picture settings

---

### Picture settings

In the Picture menu, you can adjust all picture settings individually.

To open the Picture settings, press **Home**, select **Setup** and press **OK**. Select **TV settings > Picture**.

- **Picture style**

In **Help**, press **≡ List** and look up **Picture style** for adjusting the picture style settings.

- **(3D) Backlight contrast**

Sets the contrast level of the backlight.

- **Colour**

Sets the level of colour saturation.

- **Sharpness**

Sets the level of sharpness of fine detail.

- **Noise reduction**

Filters out and reduces the image noise in the picture.

- **MPEG artefact reduction**

Smoothens the digital transitions in the picture.

- **Perfect Pixel HD**

Controls the advanced settings of the Perfect Pixel HD Engine.

— **Perfect Natural Motion** removes motion judder and reproduces smooth movement, especially in movies.

— **Clear LCD** gives a superior motion sharpness, better black level, high contrast with a flicker-free, quiet image and a larger viewing angle.

— **Super resolution** enables superior sharpness, especially on lines and contours in the picture.

— **Advanced sharpness** enables superior sharpness, especially on details in the picture.

— **Perfect contrast** sets the level at which the TV automatically enhances the details in the dark, middle and light areas of the picture.

— **Dynamic backlight** sets the level at which power consumption can be reduced by dimming the intensity of the screen. Choose for the best power consumption or for the picture with the best intensity.

— **Colour enhancement** makes the colours more vivid and improves the resolution of details in bright colours.

- **Advanced** adjusts advanced picture settings:

— **Light sensor** adjusts the picture and Ambilight settings automatically to the lighting conditions of the room.

— **Gamma** is a non-linear setting for picture luminance and contrast. Use the slider bar to set a higher or lower gamma value.

— **Colour temperature** sets the colours to **Normal**, **Warm** (reddish) or **Cool** (bluish).

— **Custom colour temperature** sets the colour temperature of the picture.

— **(3D) Video contrast** sets the contrast of the picture content.

— **Brightness** sets the brightness level of the picture.

- **Game or computer**

Sets the TV to the ideal pre-defined setting if a computer or game has been connected.

- **Format and edges**

— **Picture format**: look up and read **Picture format** with **≡ List**.

— **Screen edges** to slightly enlarge the picture to hide distorted edges.

— **Picture shift** to move the picture up / down or left / right with the cursor keys.

---

### Picture style

For easy picture adjustment, you can select a preset setting with **Picture style**.

While watching a TV channel, press **≡ OPTIONS** to open the Options menu and select **Picture style**. Select a Picture style and press **OK**.

#### Picture styles

With Picture styles, you can easily switch to the ideal picture settings for watching movies or saving energy.

Additionally, you can adjust a specific setting of a chosen Picture style, like Brightness or Contrast. The TV remembers the adjustments you made.

#### Adjust a Picture style

To adjust a Picture style . . .

**1** - Select the style and press **OK**.

**2** - Press **Home**, select **Setup** and press **OK**.

**3** - Select **TV settings**, navigate to the individual setting and adjust it.

**4** - Press **↵** to close the menu to store your setting.

To return to the original Picture style values . . .

**1** - Press **Home**, select **Setup** and press **OK**.

**2** - Select **TV settings > Picture > Picture style** and select the style you want to reset.

**3** - Press **Reset**. The style is reset.

In **Help**, press **≡ List** and look up **Picture** for adjusting separate picture settings.

The available Picture styles are . . .

- **Personal** - Your choices made in Personalise picture and sound
- **Vivid** - Ideal for daylight viewing
- **Natural** - Natural picture settings
- **Movie** - Ideal for watching movies
- **Energy saving** - Energy-conscious settings
- **Standard** - Factory standard settings
- **Photo** - Ideal for viewing photos
- **ISF Day and ISF Night** - ISF Calibration settings

### Shop or Home location

If the Picture style is switched back to **Vivid** every time you switch on the TV, the TV location is set to **Shop**. A setting for in store promotion.

To set the TV for Home use . . .

- 1 - Press **Home**, select **Setup** and press **OK**.
- 2 - Select **TV settings** > **General settings** > **Location** and press **OK**.
- 3 - Select **Home** and press **OK**.
- 4 - Press **Back**, repeatedly if necessary, to close the menu.

---

## Location

### Location

If the TV is located in a shop, you can set the TV to display an in store promotion banner. The **Picture style** is set to **Vivid** automatically. The automatic **Switch off timer** is switched off.

To set the TV to Shop location . . .

- 1 - Press **Home**, select **Setup** and press **OK**.
- 2 - Select **TV settings** > **General settings** > **Location** and press **OK**.
- 3 - Select **Shop** and press **OK**.
- 4 - Press **Back**, repeatedly if necessary, to close the menu.

---

## ISF Calibration

Get the most out of your HD TV display with ISF Calibration. You can ask an ISF calibration expert to come to your home and set the TV to the most optimal picture setting. Additionally the expert can set an ISF Calibration for Ambilight. Ask your dealer for an ISF Calibration of your TV.



The ISF Calibration expert stores and locks the ISF settings as 2 picture styles. Once the ISF Calibration is done, press **Options**, select **Picture style** and press **OK**. Select **ISF Day** to watch TV during bright light conditions or select **ISF Night** for dark light conditions.

An ISF Calibration can be done on every activity in the Home menu, like Watch TV or a connected Blu-ray Disc player.

Calibration benefits are . . .

- better picture clarity and sharpness
- better detail in bright and dark parts
- deeper and darker blacks
- better colour purity and quality
- reduced energy consumption

### Expert picture settings

When ISF Day or ISF Night is selected while an ISF Calibration is not yet performed on the TV, some expert picture settings are available. Press **Home**, select **Setup** and press **OK**. Select **TV settings** > **Picture** > **ISF expert settings** and press **OK**.

### Reset picture style settings

To reset a picture style to its original values, select the picture style you want to reset in the **OPTIONS** menu. Then Press **Home**, select **Setup** and press **OK**. Select **TV settings** > **Picture**, select **Reset**, press **OK** and confirm.

---

3.9

## Sound settings

---

### Sound

In the Sound menu, you can adjust all sound settings individually.

To open Sound settings, press **Home**, select **Setup** and press **OK**.

Select **TV settings** > **Sound**.

- **Bass**  
Sets the level of low tones in the sound.
- **Treble**  
Sets the level of high tones in the sound.
- **Balance**  
Sets the balance of the left and right speakers to best fit your listening position.
- **Surround mode**  
Sets the surround sound effect from internal speakers.
- **Headphones volume**  
Sets the volume for the headphone connection of the TV.
- **Auto volume levelling**  
Reduces sudden volume differences like at the beginning of adverts or when switching from one channel to another.

### Preferred audio format

You can set the audio format to Standard (Stereo) or Advanced (Multichannel). If one of the two types are available, the TV will switch automatically to the type you set.

- 1 - Press **Home**, select **Setup** and press **OK**.
- 2 - Select **Channel settings** > **Languages** > **Preferred audio format** and press **OK**.
- 3 - Select **Standard** or **Advanced** and press **OK**.
- 4 - Press **Back**, repeatedly if necessary, to close the menu.

### Mono / Stereo

You can set the TV to mono sound.

- 1 - Press **Home**, select **Setup** and press **OK**.
- 2 - Select **Channel settings** > **Mono / Stereo** and press **OK**.
- 3 - Select **Mono** or **Stereo** and press **OK**.
- 4 - Press **Back**, repeatedly if necessary, to close the menu.

---

## Sound style

For easy sound adjustment, you can select a preset setting with **Sound style**.

While watching a TV channel, press **III** **OPTIONS** to open the Options menu and select **Sound style**. Select a Sound style and press **OK**.

### Sound styles

With Sound styles, you can switch easily to ideal settings for speech (News) or watching movies. Additionally, you can adjust a specific setting of a chosen Sound style, like Bass or Treble. The TV remembers the adjustments you made.

### Adjust a Sound style

To adjust a Sound style . . .

- 1 - Select the style and press **OK**.
- 2 - Press **Home**, select **Setup** and press **OK**.
- 3 - Select **TV settings**, navigate to the individual setting and adjust it.
- 4 - Press **Back** to close the menu to store your setting.

To return to the original Sound style values . . .

- 1 - Press **Home**, select **Setup** and press **OK**.
- 2 - Select **TV settings** > **Sound** > **Sound style** and select the style you want to reset.
- 3 - Press **Reset**. The style is reset.

In **Help**, press **≡** **List** and look up **Sound** for adjusting separate sound settings.

The different Sound styles are . . .

- **Personal** - Your personal choices made in Personalise picture and sound
- **Original** - Factory standard
- **News** - Ideal for speech
- **Movie** - Ideal for watching movies
- **Game** - Ideal for gaming
- **Music** - Ideal for listening to music

---

## TV placement

### TV placement

As part of the first installation, this setting is set to either **On a TV stand** or **Wall mounted**.

If you have changed the placement of the TV since then, adjust this setting accordingly for best sound reproduction.

- 1 - Press **Home**, select **Setup** and press **OK**.
- 2 - Select **TV settings** > **General settings** > **TV placement** and press **OK**.
- 3 - Select **On a TV stand** or **Wall mounted** and press **OK**.
- 4 - Press **Back**, repeatedly if necessary, to close the menu.

---

3.10

## Ambilight settings

---

### Switch Ambilight on and off

To get the best Ambilight effect, keep in mind these tips :

- Dim the lighting conditions in the room and position the TV up to 25 cm away from the wall.
- Adjust Ambilight according to the colour of your wall at home in the Wall colour setting.

- Infrared remote control signals can be disturbed by Ambilight. Position your devices (disc player or Home theatre system) away from Ambilight.



Press **AMBILIGHT** on the remote control to switch Ambilight on or off and to toggle between the Ambilight settings **Off**, **Dynamic** and **Static**.

Look up and read **Ambilight dynamic** and **Ambilight static** with **≡** **List**, if you want to know more about these Ambilight settings.

You can also switch Ambilight on or off with the Ambilight menu.

Press **Home**, select **Setup** and press **OK**. Select **TV settings** and press **OK**. Select **Ambilight**.



---

### Ambilight dynamic

With **Ambilight dynamic** you can adjust the speed at which Ambilight responds to onscreen images.

Press **Home**, select **Setup** and press **OK**. Select **TV settings** and press **OK**. Select **Ambilight** > **Mode** > **Dynamic** and press **OK**. Select **Dynamic**. Use the slider bar to adapt the speed to your preference.

With **Ambilight static** you can set an Ambilight colour of your own.

Press **Home**, select **Setup** and press **OK**. Select **TV settings** and press **OK**. Select **Ambilight** > **Mode** > **Static** and press **OK**. Select **Static**. Choose your preferred colour. The Ambilight static colours are fixed (non-dynamic) colours.

---

### Ambilight settings

More Ambilight settings are available in the Ambilight menu in TV settings.

To change these settings, press **Home**, select **Setup** and press **OK**. Select **TV settings** > **Ambilight**.

### Ambilight mode

When the TV is on, you can toggle with the **AMBILIGHT** key between the Ambilight modes **Off**, **Dynamic** and **Static**. Select **Dynamic**, if Ambilight should respond to onscreen images. Select **Static** if you want to set a specific fixed colour.

### Ambilight brightness

To set the Ambilight brightness, select **Brightness** and press **OK**. Adjust the light output of Ambilight.

### Ambilight dynamic

To adjust the speed at which Ambilight responds to onscreen images, select **Dynamic**.

In **Help**, press **≡ List** and look up **Ambilight dynamic** for more information.

### Ambilight static

To set an Ambilight colour of your own. The Ambilight static colours are fixed (non-dynamic) colours.

In **Help**, press **≡ List** and look up **Ambilight static** for more information.

### Wall colour

The colour of the wall behind your TV can influence the colour effect of Ambilight.

To correct this influence, select **Ambilight > Advanced > Wall colour** and select a colour that matches the wall colour.

Ambilight will correct its colours to mix best with the colour of the wall behind the TV.

### TV switch off

To set Ambilight to switch off immediately or to fade out and switch off a few seconds after you have switched off the TV, select **Ambilight > Advanced > TV switch off**.

### Lounge light mood

In **Help**, press **≡ List** and look up **Lounge light** for more information.

---

## Lounge light

When the TV is on standby, you can switch Ambilight on and create a Lounge light effect in your room.

To switch Ambilight on while the TV is on standby, press **AMBILIGHT**.



To change the Lounge light colour scheme, press **AMBILIGHT** again.

To switch off Lounge light, press and hold **AMBILIGHT** for a few seconds.

You can also set up the colour scheme in the TV settings menu.

With the TV switched on, press **⬆️**, select **⚙️ Setup** and press **OK**.

Select **TV settings > Ambilight > Advanced > Lounge light mood**. Select the colour scheme with which Lounge light will start up.

---

3.11

## Universal access

---

### Switch on

With Universal access switched on, the TV is set for use for hearing and visually impaired people.

#### Switch on

If you did not switch on Universal access during the installation, you can still switch it on in Setup.

To switch on Universal access, press **⬆️**, select **⚙️ Setup** and press **OK**.

Select **TV settings > General settings > Universal access**.

Select **On** and press **OK**.

With Universal access switched on in Setup, the Universal access option is added in the Options menu. With Universal menu in the Options menu, you can set specific settings for hearing and visually impaired people.

---

## Hearing impaired

Some digital TV channels broadcast special audio and subtitles adapted for hearing impaired people. With Hearing impaired switched on, the TV automatically switches to the adapted audio and subtitles, if available.

#### Switch on

To switch on Hearing impaired, press **⏸️ OPTIONS**, select **Universal access** and press **OK**.

Select **Hearing impaired**, select **On** and press **OK**.

To check whether a hearing impaired audio language is available, press **⏸️ OPTIONS**, select **Audio language** and look for an audio language marked with a **👂**.

If Universal access does not appear in the Options menu, switch on **Universal access** in Setup.

In **Help**, press **≡ List** and look up **Universal access** for more information.

---

## Visually impaired

Digital TV channels can broadcast special audio commentary describing what is happening on screen. To be able to set the Visually impaired settings, Universal access must be switched on.

#### Visually impaired

With **Visually impaired**, a narrator's commentary is added to the normal audio.

To switch on the commentary (if available) . . .

- 1 - With **Universal access** switched on, press **⏏** **OPTIONS** and select the **Options** tab in the menu bar.
- 2 - Select **Visually impaired** and press **OK**.
- 3 - Select **On** and press **OK**.

You can check if a visually impaired audio commentary is available.

In the Options menu, select **Audio language** and look for an audio language marked with a .

### Speakers / Headphones

You can select where you want to hear the audio commentary. On the TV speakers only, on the headphones only or on both.

To set **Speakers / Headphones** . . .

- 1 - Press **⏏**, select **⚙️ Setup** and press **OK**.
- 2 - Select **Channel settings > Languages > Visually impaired > Speakers / Headphones** and press **OK**.
- 3 - Select **Speakers, Headphones** or **Speakers + headphones** and press **OK**.
- 4 - Press **⏪**, repeatedly if necessary, to close the menu.

### Mixed volume

You can mix the volume of the normal audio with the audio commentary.

To mix the volume . . .

- 1 - Press **⏏** **OPTIONS** and select the **Options** tab in the menu bar.
- 2 - Select **Mixed volume** and press **OK**.
- 3 - Use the arrows up and down to set the slider bar.
- 4 - Press **OK** to confirm.

### Audio effect

Some audio commentary can hold extra audio effects, like stereo or fading sound.

To switch on **Audio effects** (if available) . . .

- 1 - Press **⏏**, select **⚙️ Setup** and press **OK**.
- 2 - Select **Channel settings > Languages > Visually impaired > Audio effects** and press **OK**.
- 3 - Select **On** or **Off** and press **OK**.
- 4 - Press **⏪**, repeatedly if necessary, to close the menu.

### Speech

For speech, the audio commentary can also hold subtitles for the words which are spoken.

To switch on these subtitles (if available) . . .

- 1 - Press **⏏**, select **⚙️ Setup** and press **OK**.
- 2 - Select **Channel settings > Languages > Visually impaired > Speech** and press **OK**.
- 3 - Select **Descriptive** (audio) or **Subtitles** and press **OK**.
- 4 - Press **⏪**, repeatedly if necessary, to close the menu.

---

## Key beep

**Key beep** gives an audio feedback each time you press a key on the remote control. The volume of the beep is fixed.

### Switch on

To switch on Key beep, press **⏏** **OPTIONS**, select **Universal access** and press **OK**.

Select **Key beep** and select **On**.

If Universal access does not appear in the Options menu, switch on Universal access in Setup.

In **Help**, press **☰** **List** and look up **Universal access** for more information.

# Watch satellite

## Satellite channels

### Switch channels

To watch satellite channels, press **HOME**, select **Watch satellite** and press **OK**. The TV tunes to the satellite channel you last watched.



#### Switch channels

To switch channels, press **CH+** or **CH-**. If you know the channel number, you can use the number keys . To switch back to the previously tuned channel, press **↶**.

#### To switch to a channel from a channel list

While watching a satellite channel, press **≡ LIST** to open the channel lists. Select a list in the row of tabs.



In a channel list, navigate to a channel or radio station. With the highlight on its icon, press **OK** to switch to the channel or listen to the radio station. The channel list can have several pages with channels. To view the next or previous page, press **CH-** or **CH+**. To close the channel lists without switching channel, press **≡ LIST** again.

## Satellite channel list

### The satellite channel list

When the satellite installation is completed, the satellite channels are stored in a satellite channel list based on the predefined channel list you have chosen.

In this channel list, you can look up all installed satellite TV and radio channels.

Next to the list **All**, which holds all installed channels, you can set up a list of **Favourites**, view the installed **Radio** stations separately or discover the newly added channels in **New**.

#### To switch to a channel from a channel list

While watching a satellite channel, press **≡ LIST** to open the channel lists.

Select the satellite icon **📡** in the menu bar. Select a list in the row of tabs.



In a channel list, navigate to a TV channel or radio station. With the highlight on its icon, press **OK** to switch to the TV channel or listen to the radio station.

The channel list can have several pages with channels. To view the next or previous page, press **CH-** or **CH+**.

To close the channel lists without switching channel, press **≡ LIST** again.

#### Mark as favourite

In the channel list **All**, you can set any channel as a favourite channel.

Navigate to the channel in the list and press **YELLOW** **Mark as favourite**. The channel is added to the Favourite channel list.

#### Channel list options

With a channel list on screen, press **≡ OPTIONS** to select :

- Satellite
- Free / Scrambled
- Lock
- Unlock

#### Rename satellite channels

You can rename channels in any of the channel lists.

**1** - Highlight the channel you want to rename in one of the channel list.

**2** - Press **RED** **Rename**. You can enter text directly with the remote control keypad or open an on-screen keyboard.

#### Enter text with the remote control keypad

Use the arrow keys to position the cursor in the text. Press **←** (Backspace) to delete a character.

Select **Enter** to end Rename.

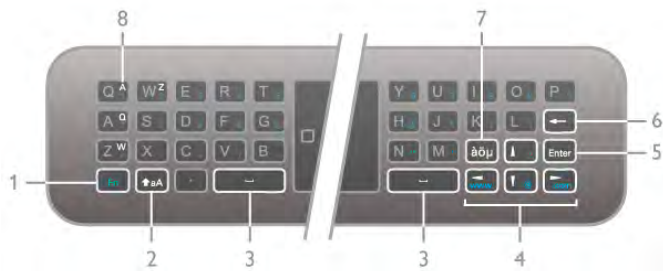

### Enter text with the on-screen keyboard

To open the on-screen keyboard on top of the text entry menu, press **OK** or any number key when the cursor in the text flashes.

On the keyboard, use the arrow keys to highlight a character and press **OK** to enter it. To delete a character, press **Backspace**.

To switch from uppercase to lowercase or to a set of special characters, press **Red**, **Green** or **Yellow**.

To close the on-screen keyboard, highlight **Done** and press **OK**.



### USB keyboard

You can use a connected USB keyboard to rename channels. Look up and read **Keyboard and Mouse** with **List** for more information.

### Reorder satellite channels

You can reposition satellite channels within the favourite satellite channels list.

In **Help**, press **List** and look up **Favourite satellite channels**.

### Favourite satellite channels

You can create a favourite channel list with only those channels you want to watch. With the Favourite channel list selected, you will only see your favourite channels when you switch through channels with **CH+** or **CH-**.

#### Create your Favourite channel list

- 1 - While watching a TV channel, press **List** to open the channel lists.
- 2 - Select the satellite icon  in the menu bar.
- 3 - Select **Favourites**.
- 4 - If the list is empty, the TV asks you to start adding channels right now. Press **OK**.
- 5 - Use the arrow keys to select a channel and press **OK** to make the selected channel a favourite channel. The order in which channels appear in the favourite list depends on the sequence in which you add them.

### Add or remove favourites

To add or remove favourite channels from the Favourite channel list, open the list and press **Options**, select **Add / remove favourites** and press **OK**.

Use the arrow keys to select a channel and press **OK** to add or remove it from the favourites list.

### Reorder

You can reorder -reposition- channels in the Favourite channels list.

- 1 - In the channel list **Favourites**, highlight the channel you want to reposition.
  - 2 - Press **Move**.
  - 3 - With the arrow keys, reposition the channel where you want it. Alternatively, you can enter the new position directly with the number keys.
  - 4 - Press **OK** to confirm the position. Or, to cancel the repositioning, press **Cancel**.
- You can highlight another channel and do the same.

### Add or remove favourites in other channel lists

You can mark channels and radio stations as favourites from the **All**, **Radio** and **New** channel list.

In these lists, highlight a channel you want to add to the favourite list and press **Mark as favourite**. The channel is marked with a star  and added to the Favourite channel list. To unmark a favourite channel, highlight the channel in any channel list and press **Unmark as favourite**. The channel is removed from the Favourite channels list.



### Satellite channel lock

To prevent children from watching a channel or a programme, you can lock channels or lock age-rated programmes.

#### Lock a channel

You can lock a channel to prevent children from watching it. To watch a locked channel you need to enter the Child lock code. To lock a channel, while watching a TV channel, press **List** to open the **Channel lists**. In any list, select the channel you want to lock, press **Options** and select **Lock channel**. In a channel list, a locked channel is marked with a lock . To unlock a channel, select the locked channel in the channel list and select the **Unlock channel** option. You will need to enter the Child lock code.

You cannot lock programmes from connected devices.

#### Parental rating

Some digital broadcasters have rated their programmes. When the rating is equal or higher than the rating you have set for your child's age, the programme will be locked. To watch a locked programme you must enter the child lock code. The parental age rating is set for all channels.

### Set an age rating

Press **Home** and select **Setup** and press **OK**.

Select **Satellite settings** > **Child lock** > **Parental rating**.

To select an age rating, you must first enter your 4-digit child lock code. If no child lock code is set, you can set the code now.

When the code is entered, you can select the age rating. When the rating of a programme is equal or higher than the rating you have set for your child's age, the programme will be locked. The TV will ask for the code to unlock the programme. For some operators, the TV only locks programmes with a higher rating.

### Change code

To change the current Child lock code, press **Home**, select **Setup** and press **OK**.

Select **Satellite settings** > **Child lock** > **Change code**.

Enter the current code and then enter the new code twice. The new code is set.

### Forgotten your code?

To override and enter a new Child lock code in case you forget it, enter **8888**.

---

4.2

## Satellite installation

---

### What you need

Next to DVB-T and DVB-C reception, this TV has a built-in satellite DVB-S/DVB-S2 receiver. If you connect a satellite dish antenna, you can receive digital satellite channels. You do not need an external satellite receiver.

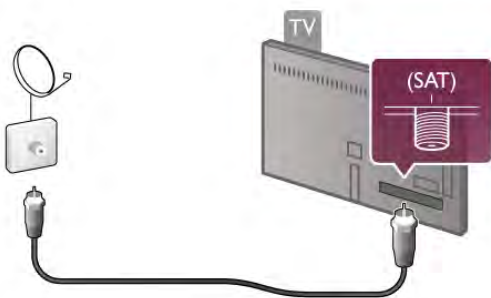

### LNB

An LNB (Low Noise Block-downconverter) captures the signals from a satellite and is mounted at the end of the pole on the dish antenna. The TV can receive signals from 4 different LNBs.

---

## Satellite channel installation

With a properly set up and connected satellite dish antenna, you can install satellite channels on the TV. Make sure your satellite dish antenna is perfectly aligned.

You can install channels from 4 different satellites (4 LNBs).

To install the satellite channels, follow the steps 1 to 5.

### 1 - Install

To search for satellites and install satellite channels, press **Home**, select **Setup** and press **OK**.

Select **Search for satellite** and press **OK**. If you have already installed satellites, select **Reinstall channels** and press **OK**.

### 2 - Connection type

Select the number of satellites you want to install. The TV sets the appropriate connection type automatically. If necessary, you can still adjust the connection type in the **Settings** later. In the **Settings** menu select **Connection type** and select **One LNB**, if you have only one LNB on your satellite dish. Select **DiSEqC Mini**, if you have 2 LNBs or select **DiSEqC 1.0** for 3 or 4 LNBs. Select **Done** to close the settings.

### 3 - Search for satellites

To start the search, select **Start** and press **OK**. The TV searches for all available satellites. This may take several minutes. If no satellites are found, check the satellite dish connections and the position of the dish antenna.

The signal quality shown is not always representative of the signal quality of all channels on that satellite.

To repeat the search for satellites, select **Search** and press **OK**. If you are satisfied with the satellites found, you can install all their channels.

### 4 - Install channels

To install all channels for the satellites you found, press **Install**. The installation may take several minutes or half an hour per satellite.

### 5 - Sorting channels

At the end of the installation, depending on the installed satellite, you can choose between different sorting lists for your satellite channels. When the installation is finished, you can find all satellite channels in the **All** satellite channels list. The channels are also sorted by type in separate lists.

### More settings

For most satellites, you do not need to change the LNB related settings but, if you are searching for a specific satellite on C-band, you need to set the LNB you use for this satellite to C-Band LNB. Or, if you are an expert user, you might need a Custom setting for the LNBs you use.

To speed up searching for satellites and channels, set the Frequency scan rate to 10MHz. To do a thorough scan, set the rate to 2MHz (recommended for Turkish satellites).

### Reset

You might have lost track of the settings you set up.

To reset the satellite installation settings to factory settings, select **Reset** in **Settings** and press **OK**.

### Manual installation

The automatic channel install might have missed a specific channel or channels from a transponder. You can add a transponder manually. Look up and read **Manual installation** with **List**.

### Dish antenna connection

Look up and read about the **Dish cable** with **List**.

Find the list of preset satellites on this TV in **List** > **Specifications** > **Power and reception**.



---

## Add a satellite

If satellite channels are already installed, you can add an extra satellite to the installation. You can install channels from 4 different satellites - 4 LNBs.

### 1 - Connection type

Check the Connection type setting before you add a satellite. The setting Single receives only one LNB, the setting DiSEqC Mini receives only 2 LNBs and the setting DiSEqC 1.0 can receive 3 or 4 LNBs.

To check the Connection type first, press **⬆**, select **⚙️ Setup** and press **OK**.

Select **Search for satellite > Reinstall channels > Settings** and press **OK**.

Select **Connection type** and select the setting you need for the number of satellites you want to install. Select **Done** to close the settings. Press **⬅** to close Reinstall channels.

### 2 - Add a satellite

To add a satellite, press **⬆**, select **⚙️ Setup** and press **OK**. Select **Search for satellite > Add satellite** and press **OK**. The TV searches for a satellite on the first free LNB. This may take several minutes.

If no satellites are found, check the antenna connections and the position of the dish antenna. Select **Search** or **Next LNB**. If there are no free LNBs, you can remove a satellite first. Read Remove satellites below.

### 3 - Install channels

If you are satisfied with the added satellite, you can install the channels.

To install all channels, press **Install**. The installation may take several minutes.

### 4 - Remove a satellite

To remove a satellite, press **⬆**, select **⚙️ Setup** and press **OK**.

Select **Search for satellite > Remove satellite** and press **OK**. Select the satellite you want to remove and press **OK**. To confirm, select **Yes** and press **OK**. The satellite and its channels are removed from the installation.

---

## Update channels

---

### Update satellite channels

The TV puts all installed channels in various channel lists. If you receive digital channels, you can set the TV to automatically update the list with new channels. You can also start a channel update yourself.

### Automatic channel update

Once a day, at 4 AM, the TV updates the channels and stores new channels in the All channels list, their corresponding channel list and in the New channels list. Channel positions without an incoming signal are removed. For new or removed channels, a message is shown at TV start up. The TV must be in standby to automatically update channels.

To switch off the message at start up, press **⬆**, select **⚙️ Setup** and press **OK**.

Select **Channel settings > Channel installation > Channel update message** and select **Off**.

To switch off the automatic channel update, press **⬆**, select **⚙️ Setup** and press **OK**.

Select **Channel settings > Channel installation > Automatic channel update** and select **Off**.

### Start a channel update

To start an update yourself, press **⬆**, select **⚙️ Setup** and press **OK**.

Select **Search for channels** and press **OK**. Follow the instructions on screen. The update may take several minutes.

---

### Recently added channels

New channels added with the automatic channel update are easy to find in the channel list **New**. The same new channels are also stored in the **All** or **Radio** channel list.

New channels are kept in the channel list New as long as you don't mark them as a favourite or tune to them.

In **Help**, press **☰ List** and look up **Favourite satellite channels** for marking channels as favourites.

---

## Channel list copy

---

### Introduction

Channel list copy is intended for dealers and expert users.

Channel list copy will copy both terrestrial and satellite channels.

With **Channel list copy**, you can copy the channels installed on one TV onto another Philips TV of the same range. With Channel list copy, you avoid the time-consuming channel search and you can offer a predefined channel list setup. The small file you copy fits every USB memory device.

### Conditions

- Both TVs are from the same year range.
- Both TVs have the same product type suffix for DVB (H, K, M, T or D/00) in their type number and have the TV installed for the same country.
- Both TVs have an identical satellite installation setting.
- Both TVs have the same hardware type. Check the hardware type on the TV type plate on the back of the TV. Typically noted as Q . . . LA

- Both TVs have compatible software versions. When you upload, an on-screen message will warn you if software versions are not compatible.

---

### Copy a channel list

#### Copy a channel list

- 1 - Switch on the TV which has its channels installed. Plug in a USB memory device.
- 2 - Press **Home**, select **Setup** and press **OK**.
- 3 - Select **TV settings > General settings > Channel list copy > Copy to USB** and press **OK**. To copy the channel list from this TV, you might be asked to enter the Child lock code you entered during the installation.
- 4 - When copying is done, unplug the USB memory device.

Now you can upload the copied channel list onto another Philips TV.

---

### Upload a channel list

#### Upload a channel list

Depending on whether your TV is already installed or not, you must use a different way to upload a channel list.

#### To a TV that's not yet installed

- 1 - Plug in the power plug to start the installation and select language and country. You can skip Search for channels. Finish the installation.
- 2 - Plug in the USB memory device that holds the channel list of the other TV.
- 3 - To start the channel list upload, press **Home**, select **Setup** and press **OK**.
- 4 - Select **TV settings > General settings > Channel list copy > Copy to TV** and press **OK**. You might be asked to enter the Child lock code of this TV.
- 5 - The TV notifies if the channel list is copied to the TV successfully. Unplug the USB memory device.

#### To an already installed TV

- 1 - Verify the country setting of the TV. (To verify this setting, press **Home**, select **Setup** and press **OK**. Select **Search for channels > Reinstall channels** and press **OK**. Press **Back** and later **Cancel** to leave the Search for channels.)  
If the country is correct continue with step 2.  
If the country is not correct, you need to start a reinstallation. To start the reinstallation, press **Home**, select **Setup** and press **OK**. Select **Search for channels > Reinstall channels** and press **OK**. Select the correct country and skip the Search for channels. Finish the installation. When done, return to step 2.
- 2 - Plug in the USB memory device that holds the channel list of the other TV.
- 3 - To start the channel list upload, press **Home**, select **Setup** and press **OK**.
- 4 - Select **TV settings > General settings > Channel list copy > Copy to TV** and press **OK**. You might be asked to enter the Child lock code of this TV.
- 5 - The TV notifies if the channel list is copied to the TV successfully. Unplug the USB memory device.

---

## Manual installation

With **Manual installation**, you can check the signal strength of a satellite.

To start Manual installation, press **Home**, select **Setup** and press **OK**.  
Select **Search for satellite > Manual installation** and press **OK**.

- 1 - Select the LNB.
- 2 - If you know the frequency of the transponder (which can hold several channels), select **Frequency** and enter it.
- 3 - Select **Search** and press **OK**.
- 4 - If the TV finds a frequency and there is a store button shown, a new transponder has been found.
- 5 - Press **Store** to add the new transponder with its channel or channels to the channel list.

To add another transponder, select **Exit** and repeat the steps. If you use a Multiple Dwelling Unit (MDU) for Eutelsat W3 7E (especially for DIGITURK), Manual installation is not available.

---

## Troubleshooting

### The TV cannot install the satellite I want

- Check the orientation of the satellite dish.
  - Check the setting for the LNB that you use for this satellite.
  - Check the connection type in the satellite installation settings.
  - Reset all satellite settings if you lost track of the settings you changed.
- In **Help**, press **Menu** **List** and look up **Satellite installation** for more information.

### The reception of a satellite channel is poor

- Check the orientation of the satellite dish.

### Sometimes the reception is poor

- Check if the satellite dish is solidly mounted. Strong winds can move the dish.
- Snow and rain can degrade reception.

# 3D

## 5.1

## What you need

This is a 3D Max TV. On this TV, you can watch 3D programmes and movies in full High Definition resolution with 3D Max.



To watch 3D you need to :

- tune to a TV channel that broadcasts programmes in 3D
- rent a movie in 3D from an online video store with Smart TV
- watch a movie in 3D from a 3D Blu-ray Disc, a USB device or computer

Also, to watch 3D on this TV, you will need the Philips 3D Max active glasses PTA507 or PTA517 (sold separately). Other active 3D glasses might not be supported.

## 5.2

## Your 3D glasses

### Rechargeable active 3D glasses PTA507

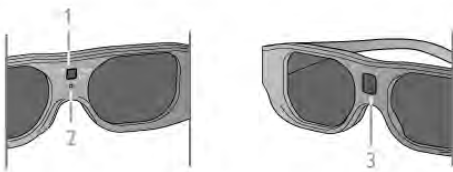

- 1 - On switch / Player 1 or 2 selection
- 2 - LED indicator
- 3 - Receiver lens

#### Switch on

To watch a 3D picture on TV, press **On** on the 3D glasses and put them on. The glasses need some seconds to adjust to the 3D signal from the 3D transmitter on the TV. At first use, this may take up to 15 seconds.

Make sure the receiver lens in the centre of the glasses can receive the 3D signals. Also, clear objects away from the 3D transmitter on the TV.



#### Switch off

When the 3D glasses do not receive 3D signals for 2 minutes, the glasses switch off automatically.

#### Two-player gaming

You can use these glasses to play two-player games. Two players can watch the same TV but see two different screens to play a game.

To switch the glasses to watch the Player 1 or Player 2 screen, switch on the glasses and then press the **On** key repeatedly.

In **Help**, press **≡ List** and look up **Two-player gaming** for more information.

#### Battery level

You can check the battery level when you switch on the 3D glasses.

During the first 5 seconds the LED indicator blinks . . .

- Red - if there is less than 1 hour of 3D viewing remaining
- Orange - 1 to 3 hours remaining
- Green - more than 3 hours remaining.

#### Charging the 3D glasses

To charge the glasses, plug in the micro USB plug and connect the standard USB plug to the TV, PC or USB hub. The TV or PC must be switched on to charge. Charging the empty battery may take up to 3 hours. A fully charged battery allows 20 hours of 3D watching.



When charging, the LED indicator is on and is . . .

- Red - charging
- Green - fully charged

#### Care of the 3D glasses

- Do not expose the 3D glasses to direct sunlight, heat, fire or water. This may result in a product malfunction or fire.
- Use a clean soft cloth (microfiber or cotton flannel) to clean the lenses to avoid scratching them. Never spray cleaner directly onto the 3D glasses. This may damage the electronics.
- Do not drop, bend or apply force to the lenses of the 3D glasses.
- Do not use cleaning chemicals containing alcohol, solvent, surfactant, or wax, benzene, thinner, mosquito repellent or lubricant. Using these chemicals can cause discoloration or cracks.

## 5.3

## Watch 3D

#### 3D switching

The first time a 3D signal is detected, you can set your preference how to start 3D in the future.

To switch to 3D automatically, select **Automatic**.

To show a notification first, select **Notify**.

To never switch to 3D, select **No 3D**.

You can still change this preference in the 3D menu later.

To open the 3D menu, press **3D** and select **Switch to 3D** to set your preference.



### Start 3D

When the TV switches to 3D or when a notification is shown that 3D is available, switch on your active 3D glasses and put them on.

If the TV cannot detect the 3D signal (the 3D signal tag is missing), the 3D programme is shown as a double image on screen. To switch to 3D, press **3D** and select **Side by side** or **Top / bottom** according to the double image positions.

### Stop 3D

To stop watching 3D, press **[[[ OPTIONS**, select **3D depth** and select **Off**.

3D is switched to 2D when you switch to another channel or connected device.

### 2D to 3D conversion

You can convert any 2D programme to watch it in 3D.

To convert a 2D programme to 3D, press **3D**, select **2D to 3D conversion** and confirm with **OK**.

To stop the 2D to 3D conversion, press **[[[ OPTIONS**, select **3D depth** and select **Off** or switch to another activity in the Home menu. The conversion will not stop if you switch between TV channels.

You can change the depth of 3D for a weaker or stronger 3D effect in the 2D to 3D conversion.

To change the 3D depth, press **[[[ OPTIONS** and select **3D depth**. Select **Off** (no 3D), **Less** (less 3D depth), **Normal** (optimal 3D quality) or **More** (more 3D depth).

---

5.4

## Optimal 3D viewing

For an optimal 3D viewing experience, we recommend that you:

- sit at least 3 times the height of the TV screen away from the TV, but no further than 6 meters away.
- avoid fluorescent lighting (such as TL lighting or certain energy saving light bulbs which operate on a low frequency) and direct sunlight as they may interfere with the 3D experience.

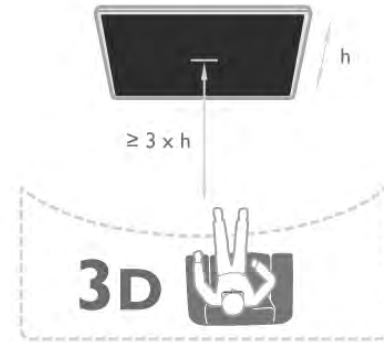

---

5.5

## Health warning

- If you or your family have a history of epilepsy or photosensitive seizures, consult a medical professional before exposing yourself to flashing light sources, rapid image sequences or 3D viewing.
- To avoid discomfort such as dizziness, headache or disorientation, we recommend not watching 3D for extended periods of time.

**If you experience any discomfort, stop watching 3D and do not immediately engage in any potentially hazardous activity (for example driving a car) until your symptoms have disappeared. If symptoms persist, do not resume watching 3D without consulting a medical professional first.**

- Parents should monitor their children during 3D viewing and ensure they do not experience any discomfort as mentioned above. Watching 3D is not recommended for children under 6 years of age as their visual system is not fully developed yet.
- Do not use the 3D glasses for any purpose other than watching 3D TV.

---

5.6

## Care of the 3D glasses

- Do not expose the 3D glasses to direct sunlight, heat, fire or water. This may result in a product malfunction or fire.
- Use a clean soft cloth (microfiber or cotton flannel) to clean the lenses to avoid scratching them. Never spray cleaner directly onto the 3D glasses. This may damage the electronics.
- Do not drop, bend or apply force to the lenses of the 3D glasses.
- Do not use cleaning chemicals containing alcohol, solvent, surfactant, or wax, benzene, thinner, mosquito repellent or lubricant. Using these chemicals can cause discoloration or cracks.

# Smart TV

## 6.1

### Home menu

From the Home menu, you can start any activity you can do with the TV.

Open the Home menu to start watching TV or start watching a disc on your Home Theatre System. Also in the Home menu, you can open Smart TV to surf the Internet, start Skype or open Help if you need information on using the TV.

#### Open the Home menu

To open the Home menu, press .

Select an activity using the arrow keys and press **OK** to start the activity.

To close the Home menu without changing the current activity, press  again.



#### - TV

Select **TV** and press **OK** to watch TV channels.

#### - Satellite

Select **Satellite** and press **OK** to watch satellite channels (only for TVs with a built-in satellite tuner).

#### - Smart TV

Select **Smart TV** and press **OK** to open the Smart TV start page.

#### - Source

Select **Source** and select a connected device in the list underneath the icon. Press **OK** to switch to the selected device.

#### - TV guide

Select **TV guide** and press **OK** to open a list of the current and scheduled TV programmes of your channels.

#### - Recordings

Select **Recordings** and press **OK** to open the list of your recordings (only available if you connect a USB Hard Drive).

#### - Skype

Select **Skype** to make video calls for free.

#### - Setup

Select **Setup** to install channels or adjust all TV settings.

#### - Help

Select **Help** and press **OK** to open the on screen Help. You can look up a topic in an alphabetical list.

# Smart TV Apps

## What you need

To enjoy Smart TV Apps you must connect the TV to a router with a high-speed (broadband) connection to the Internet. You can use a home network connected to the Internet. You do not need a computer.

In **Help**, press  **List** and look up **Network** for more information.

#### Tip

To enter text or to navigate an Internet page more easily, you can consider to connect a USB keyboard and a USB mouse to the TV. The USB mouse can only navigate pages on the Internet, it cannot navigate Smart TV App pages.

In **Help**, press  **List** and look up **USB keyboard** or **USB mouse** for more information.

## Configure

The first time you open Smart TV, you need to configure your connection. Read and agree to the terms and conditions to continue. To leave Smart TV, press .

#### Register

Register with Club Philips.

Select **Register** and press **OK**.

Enter your email address, select **Continue** and press **OK**. Confirm the email address.

#### Parental control

To lock Adult 18+ rated apps, switch on Smart TV parental control by selecting **Enable** and then press **OK**.



Enter an unlock PIN code of your choice.

Confirm your PIN code. Adult 18+ rated apps are now locked.

To open a locked app, select the app and press **OK**. The TV will ask you to enter your 4-digit code.

#### Reconfigure

To reconfigure your connection with Smart TV, clear the Internet memory on the TV.

To clear the Internet memory, press  and select  **Setup** and press **OK**.

Select **Network settings** > **Clear Internet memory** and press **OK**.

## Smart TV start page

The Smart TV start page is your link with the Internet. You can rent movies online, read newspapers, watch videos and listen to music, also shop online, open your social network page or watch TV programmes when it suits you with Online TV. To do this, you open Apps - Internet sites which are tailored for TV. With your TV connected to the Internet, you can open Smart TV.

## Open Smart TV

To open the Smart TV start page, press **Smart TV**.  
Alternatively, you can press **Home**, select **Smart TV** and press **OK**.



The TV connects to the Internet and opens the Smart TV start page. This may take a few seconds.



- 1 - Now on your TV
- 2 - Your Apps
- 3 - App gallery
- 4 - Internet
- 5 - Recommended Apps
- 6 - Search
- 7 - Colour keys for control

## Your Apps

You start Apps from the Smart TV start page. If the start page does not hold any Apps yet, you can add Apps from the App gallery.  
The list of your Apps can be several pages long. Use the arrow keys to go to the next or previous page. Alternatively, press **CH+** (Next page) or **CH-** (Previous page).

## App gallery

In the App gallery you find all available Apps.

## Internet

The **Internet** App opens the World Wide Web on your TV. On your TV, you can view any Internet website but most of them are not tailored for a TV screen.  
- Some plug-ins (e.g. to view pages or videos) are not available on your TV.  
- Internet pages are shown one page at a time and full screen.

## Recommended Apps

In this window, Philips presents a range of recommended Apps for your country, Apps for Online TV or a selection of rental movies from Video stores. You can select and open them from the Recommended Apps window.

## Search

With Search, you can search the App gallery for relevant Apps. Enter a keyword in the text field, select **Q** and press **OK** to start searching. You can enter names, titles, genres and description keywords to search.  
Alternatively, you can leave the text field empty and search for the most popular searches/keywords for a range of categories. In the list of found keywords, select a keyword and press **OK** to search for items with that keyword.

In the list of Apps on the Smart TV start page you can . . .

## Remove an App

To remove an App from the Smart TV start page, select the App icon and press **Remove**.

## Move an App

To reposition an App in the list, select the App icon, press **Move** and use the arrow keys to reposition the App. Press **OK** to confirm the position.

## Lock an App

To lock an App, select the App icon and press **Lock**. When you lock an App, you must enter the 4 digit PIN code you set for Parental control when you configured Smart TV. In the list, a locked App is marked with a lock **🔒**.  
To unlock an App, select the App icon and press **Unlock**. You must enter the 4 digit PIN code to unlock.

## Feedback on an App

Select the App and press **Feedback** to select a 'like' or 'don't like' button and send a suggestion or remark to us. You can also report an App malfunction.

## Close Smart TV

To close the Smart TV start page, press **Home** and select another activity.

TP Vision Netherlands B.V. bears no responsibility regarding the content and the quality of the content provided by the content service providers.

## Using Apps

To start an App, you must add it to your list of Apps in the Smart TV start page first.  
You can add Apps to your list from the App gallery.

## App gallery

In the App gallery you find all available Apps. The App gallery shows Apps in lists per country.  
To open the App gallery, select the App gallery icon on the Smart TV start page and press **OK**.  
In the App gallery, use the arrow keys to select items in the page.  
To view the Apps ordered by category, press **All Apps**, select a category and press **OK**.  
To view the Apps from another country, press **Country**, select a country and press **OK**.  
To lock an App, select the App icon and press **Lock**. When you lock an App, you must enter the 4 digit PIN code you set for Parental control when you configured Smart TV. In the list, a locked App is marked with a lock **🔒**.  
To unlock an App, select the App icon and press **Unlock**. You must enter the 4 digit PIN code to unlock.

To return to the Smart TV start page, press **≡ LIST** or **↶**.

### Add an App to your list

In the App gallery, select the App icon and press **OK**.  
Select **Add** and press **OK**.

Alternatively, select **Add and move** to add it and immediately position the App where you want it in your list.

### Start an App

To start an App, press **🏠** and select **Smart TV**.

On the start page, select an App icon and press **OK**.

In an App, press **↶** to go back 1 step or page.

### Reload an App page

If an App page did not load properly, press **≡ OPTIONS** and select **Reload** to reload the page.

### Zoom

You can zoom in on an App page.

To zoom a page, press **≡ OPTIONS** and select **Zoom page**.

Use the slider bar to set the zoom level.

Return to normal view by resetting the slider bar.

### View security info

You can check the security level of an App page.

On an App page, press **≡ OPTIONS** and select **Security info**. If a lock **🔒** is shown next to the loading animation on the bottom of the screen while loading a page, the transfer is secured.

### Close an App

To close an App and return to the Smart TV start page, press **Smart TV**.

---

## Rental video Apps

With the video store Apps in Smart TV, you can rent your favourite movie from an online rental video store. You can pay securely with your credit card.

### Rent a movie

**1** - Open a Video store App in your list of Apps or select a recommended video on the Smart TV start page.

**2** - Select a movie.

**3** - Make the online payment.

**4** - Download the video.

**5** - Start watching. You can use the **▶** (Play) and **⏸** (Pause) keys.

Most Video stores ask you to create a log in account.

### Streaming video

With this TV, you can watch rental movies sent as a streaming video format. You can almost instantly watch the movie. When the rental video store uses video streaming, you might need a USB Hard Drive to store some video buffer. You can pause or restart a rental movie sent with streaming video.

If you have a USB Hard Drive connected, you can also download rental movies from video stores that offer movie downloading only. You can pause or restart a downloaded rental movie.

Consult the video store regarding the rental duration of rental movies.

### Internet traffic

Streaming or downloading many videos may exceed your monthly Internet traffic limit.

---

## Online TV

With the Online TV App on the Smart TV start page\*, you can watch TV programmes you missed or watch programmes whenever it suits you best.

### Open Online TV

To open the Online TV App, press **🏠** and select **Smart TV**.  
On the start page, select the **◀ Online TV** icon and press **OK**.

Select a programme on the page and press **OK** to start watching.

You can use the **▶** (Play) and **⏸** (Pause) keys.

### List per broadcaster

To view the Online TV programmes ordered by broadcaster, press **📺 All broadcasters**.

Select a broadcaster and press **OK**.

\* If available in your region.

---

6.3

## Videos, photos and music

---

### From a USB or network

You can view your photos or play your music and videos from a connected USB flash drive or USB Hard Drive. If you have a computer in your home network, you can view and play your files from your computer on the TV.

### From a USB device

With the TV switched on, plug in a USB flash drive or USB Hard Drive to one of the USB connections. The TV detects the device and lists your files.

If the list does not appear automatically, press **SOURCE**, select **Browse USB** and press **OK**.

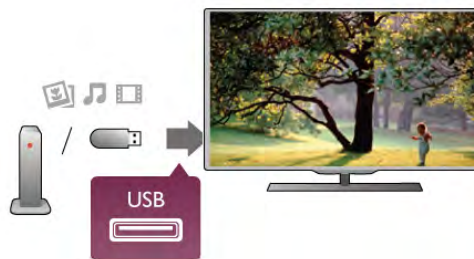

### Warning

If you try to pause or record a programme with a USB Hard Drive connected, the TV will ask you to format the USB Hard Drive. This formatting will delete all current files on the USB Hard Drive.

### From a computer

If the TV and the computer are in the same network, the TV can browse and play files stored on your computer. This TV uses the DLNA protocol and is compatible with other DLNA devices.

On your computer, you need to install media server software like Twonky™ to share your files with the TV. The TV shows your files and folders as they are organised on your computer. To browse the files on your computer, press **SOURCE**, select **Browse network** and press **OK**.

---





## Menu bar and sorting

With a USB device connected, the TV sorts the files by type. Navigate to the menu bar and select the type of file you are looking for.

If you browse files from a computer, you can only browse the files and folders as they are organized on the computer.

### The menu bar

Navigate to the menu bar and select the type of file you want to watch or play.

Select  **Photos**,  **Music** or  **Videos**. Alternatively, you can open the  **Folders** view and browse your folders to look for a file.

### Sorting

To browse your photos by date, month, year or alphabetically by name, press  **Sort**.

To browse your music by album, artist, genre or alphabetically by name, press  **Sort**.

Videos are sorted alphabetically.



---

## View photos

To view photos, select  **Photos** in the menu bar, select a photo thumbnail and press **OK**.

If there are several photos in the same folder, select a photo and press  **Slide show** to start a slide show of all photos in this folder.



To jump to the next or previous photo, press **CH+** or **CH-**.

To stop the slide show or close the photo, press  **LIST** or  (Stop).

You can play music with a slide show.

Start the slide show after you started the music.

1 - Select a song or a folder with songs and press **OK**.

2 - Press  **LIST** and select  **Photos**.

3 - Select a photo or a folder with photos and press  **Slide show**.

### Info

To view info on a photo (size, creation date, file path, etc.), select a photo and press  **INFO**.

Press again to hide the info.

### Options

Press  **OPTIONS**.

#### - Shuffle

Shows your photos randomly.

#### - Repeat

Plays the slide show continuously.

#### - Slide show speed

Sets the speed of the slide show.

#### - Slide show transition

Sets the style of the photo transitions.

To close **Browse USB** or **Browse network**, press  and select another activity.

---



## Play music



To play music, select  **Music** in the menu bar, select a song and press **OK**.

If there are more songs in the same folder, press  **Play all** to play all songs in this folder.

To jump to the next or previous song, press **CH+** or **CH-**.

To pause the music, press **OK**. Press **OK** again to continue.

To make a 10-second jump in a song or 10-second jump back, press  or .

To rewind or go fast forward, press  or . Press the keys several times to speed up - 2x, 4x, 8x, 16x, 32x.

To stop the music playback, press  (Stop).

If you press  **LIST** or , the music keeps on playing.

### Info

To view song info (title, artist, duration, etc.), select the song and press  **INFO**.

Press again to hide the info.

### Options

Press  **OPTIONS**.

#### - Shuffle

Plays your music randomly.

#### - Repeat

Plays the song once or continuously.

### Screen off

If you only listen to music, you can switch off the TV screen to save energy.

To switch off the screen, press  **OPTIONS**, select  **Eco settings** in the menu bar, select **Screen off** and press **OK**. To switch the screen back on, press any key on the remote control.

To close **Browse USB** or **Browse network**, press  and select another activity.

---

## Play videos

To play a video, select  **Videos** in the menu bar, select a video and press **OK**.

If there are more videos in the same folder, press  **Play all** to play all videos in this folder.

To jump to the next or previous video, press **CH+** or **CH-**.

To pause the video, press **OK**. Press **OK** again to continue.



To make a 10-second jump forward or backward in a video, press ► or ◀.

To rewind or go fast forward, press ◀◀ or ▶▶. Press the keys several times to speed up - 2x, 4x, 8x, 16x, 32x.

To stop the video playback, press ■ (Stop).

### Info

To view info on a video (playhead position, duration, title, date, etc.), select the video and press **i** INFO.

Press again to hide the info.

### Options

Press **≡** OPTIONS.

#### - Subtitles

If available, you can switch subtitles **On**, **Off** or **On during mute**.

#### - Shuffle

Plays your videos randomly.

#### - Repeat

Plays a video once or continuously.

#### - DivX® VOD

Opens the DivX registration.

To close **Browse USB** or **Browse network**, press **↑** and select another activity.

---

## DivX® VOD

This TV is DivX Certified® and plays high-quality DivX Video-On-Demand videos.

To play DivX VOD videos from a video store or from your computer, you must activate DivX VOD on the TV first. The DivX VOD activation of your TV is free of charge.

### Register

If the TV is not yet activated when you start the playback of a rental DivX video, the TV will show you the DivX registration code to activate this TV.

To register follow these steps.

- 1 - When the TV shows the 8 or 10-digit registration code, write down the code and go to <http://vod.divx.com> on your computer
- 2 - Download and install the DivX player software on your computer.
- 3 - Start the DivX player software and create a DivX Account (VOD > Create a DivX Account . . .)
- 4 - In the DivX player, register the TV with the registration code of the TV (VOD > Register a DivX Certified Device . . .)
- 5 - Download and save the registration video when asked.
- 6 - Transfer the registration video to the TV. You can use a USB flash drive or your network connection.
- 7 - Play the registration video on your TV. This completes the registration and activates DivX on your TV.

Consult the DivX website for detailed support.

### Deregister

You can deregister the TV and deactivate DivX VOD playback. To deregister, press **SOURCE**, select **Browse USB** and press **OK**.

Press **≡** OPTIONS, select **DivX® VOD** and press **OK**.

DivX®, DivX Certified® and associated logos are trademarks of Rovi Corporation or its subsidiaries and are used under license.

ABOUT DIVX VIDEO: DivX® is a digital video format created by DivX, LLC, a subsidiary of Rovi Corporation. This is an official DivX Certified® device that plays DivX video. Visit [divx.com](http://divx.com) for more information and software tools to convert your files into DivX videos.

ABOUT DIVX VIDEO-ON-DEMAND: This DivX Certified® device must be registered in order to play purchased DivX Video-on-Demand (VOD) movies. To obtain your registration code, locate the DivX VOD section in your device setup menu. Go to [vod.divx.com](http://vod.divx.com) for more information on how to complete your registration.

---

6.4

## Pause TV

While watching a broadcast from a digital TV channel, you can pause the broadcast and continue watching later on. Answer a phone call or take a break. Meanwhile, the broadcast is buffered (not stored) on the USB Hard Drive. You can pause a broadcast for a maximum time span of 90 minutes.

### Pause a broadcast

To pause a broadcast, press **⏸** (Pause). A progress bar appears briefly on screen.

To call up the progress bar, press **⏸** (Pause) again.

To continue watching, press **▶** (Play).

To switch to TV broadcast again, press **■** (Stop).



The moment you switch to a digital channel, the USB Hard Drive starts storing the broadcast. When you switch to another digital channel, broadcast of the new channel is stored and the broadcast of the former channel is cleared. When you switch to a connected device (a Blu-ray Disc player or digital receiver) the USB Hard Drive stops storing and the broadcast is cleared. Also when you switch the TV to standby the stored broadcast is cleared.

Whilst recording a programme on the USB Hard Drive, you cannot pause a broadcast.

### Instant replay

Whilst watching a broadcast from a digital TV channel, you can easily instant replay the broadcast.

To replay the last 10 seconds of a broadcast, press **⏸** (Pause) and press **◀** (Left).

You can press **◀** repeatedly until you reach the start of the broadcast storage or the maximum time span.

### Progress bar

With the progress bar on screen, press ◀◀ (Rewind) or press ▶▶ (Forward) to select from where you want to start viewing the stored broadcast. Press these keys repeatedly to change their speed.

### Specifics

The Audio Description audio (commentary) for the visually impaired is not available for playback in Pause TV or Recording.

In **Help**, press ≡ **List** and look up **USB Hard Drive, installation** to install Pause TV.

---

6.5

## Recording

---

### Record a program

If a USB Hard Drive is connected and formatted and the TV receives electronic TV guide information, you can record a digital TV broadcast.

In **Help**, press ≡ **List** and look up **USB Hard Drive, installation** to install a USB Hard Drive.

#### Record now

To record the programme you are watching, press ● (Record) on the remote control.



If you receive TV guide information from the Internet, you can adjust the end time of the recording in the pop-up window before you confirm the recording.

If you receive TV guide information from the broadcaster, the recording starts immediately. You can adjust the end time of the recording in the list of recordings. See below.

To stop recording, press ■ (Stop).

#### Schedule a recording

You can schedule a recording of an upcoming programme for today or a few days from today (maximum of 8 days away).

1 - To schedule a recording, press **Guide**.

On the TV guide page, select the channel and programme you wish to record.

You can enter the channel number to jump to the channel in the list.

Press ▶ (Right) or ◀ (Left) to scroll through the programmes of a channel.

To change the date of the list, press ≡ **OPTIONS** and select **Select day**. In the list, select the day you want and press **OK**. If the TV guide comes from the Internet, you can select the date at the top of the page and press **OK**.

2 - With the programme highlighted, press ■ **Record** or press ≡ **OPTIONS** and select **Record**. The TV adds some time buffer at the end of the program. You can add some extra buffer if needed.

3 - Select **Schedule** and press **OK**. The programme is scheduled for recording. A warning will show automatically when overlapping recordings are scheduled.

If you plan to record a programme in your absence, remember to leave the TV switched to standby and the USB Hard Drive switched on.

#### List of recordings

To view the list of recordings and scheduled recordings, press 🏠, select 📺 **Recordings** and press **OK**. In this list, you can select a recording to watch, remove recorded programmes, adjust the end time of an ongoing recording or check the free disc space. Also in this list, if the TV guide comes from the Internet, you can schedule a recording of which you set the beginning and end time yourself, as a timed recording not linked to a programme. To set a timed recording, select **Schedule recording** at the top of the page and press **OK**. Set the channel, date and time span. To confirm the recording, select **Schedule** and press **OK**.

#### Remove a scheduled recording

To remove a scheduled recording, select the upcoming recording in the list and press **OK**. Alternatively, you can select the scheduled recording and press ≡ **OPTIONS** and select **Cancel recording**.

#### Specifics

- While recording a programme, you can watch a previously recorded programme.
- While recording, you cannot switch TV channels.
- While recording, you cannot pause the TV broadcast.
- To Record, broadcasters need a reliable clock setting. If you reset the TV clock manually, recordings may fail.
- The Audio Description audio (commentary) for the visually impaired cannot be recorded.

In **Help**, press ≡ **List** and look up **Watch a recording** to watch and manage your recordings.

---

### Watch a recording

To watch a recording, press 🏠, select 📺 **Recordings** and press **OK**.

In the list, select the recording and press ▶ (Play) to start the playback.

You can use the ▶▶ (Forward), ◀◀ (Rewind), || (Pause) or ■ (Stop) keys on the remote control.



#### Expired recording

Broadcasters can limit the number of days a recording can be viewed. A recording in the list can show the number of days before it expires.

### Failed recording

When a scheduled recording was prevented by the broadcaster or when the broadcast was interrupted, a recording is marked as **Failed**.

### Delete a recording

To delete a made recording, select the recording in the list, press **≡** **OPTIONS** and select **Delete recording**.

In **Help**, press **≡** **List** and look up **Record a program** for more information.

6.6

## MyRemote App

### About MyRemote App

Download the **MyRemote app** on your smartphone or tablet. With the MyRemote app you turn your smartphone or tablet into a full remote control for your TV.



With the MyRemote app, you can also send your media - photos, music and videos - from your smartphone to the TV or from a computer to the TV. Select the files on your smartphone or tablet and enjoy the photos stored on your computer on the big TV screen or listen to music stored on your computer through the loudspeakers of your Philips Home Theatre System\*.

You are in control with your mobile device.

If you have a tablet, you can call up the TV guide. You can consult the TV schedule and read programme info. You can tap the programme to switch to the TV channel directly.

### It's free

Installing the MyRemote app on your smartphone or tablet is free of charge.

### Languages

The following languages are available in the MyRemote App : English, German, French, Italian, Spanish, Portuguese, Dutch and Russian.

If the language set on your mobile device is not one of these languages, the MyRemote App language is switched to English.

\* You can check the compatibility of MyRemote with your specific Philips product at the online support page of your product at [www.philips.com/support](http://www.philips.com/support). Also ensure your product has been upgraded with the latest software.

## What do you need

### Home network

Your TV, smartphone, tablet and computer, must be linked up with your home network to enjoy the MyRemote app.

To connect the TV to your home network . . .

- 1 - Connect your network router to the Internet, if it was not connected yet (a broadband Internet connection).
- 2 - Connect the TV to your network router. You can do this wireless or wired.

In **Help**, press **≡** **List** and look up **Network, wireless** or **Network, wired** for more information.



### Media server software

If you want to view your photos or play your music and videos from your computer on the TV, you have to install media server software on your computer. Setup this media server software to share your files on your home network. This TV uses the DLNA protocol and is compatible with other DLNA devices.

In **Help**, press **≡** **List** and look up **DLNA, supported media servers** for the list of media server software that is compatible with the TV.

### Digital Media Renderer - DMR

If your media files do not play on your TV, make sure that the **Digital Media Renderer** is switched on. As a factory setting, DMR is switched on.

To check if DMR is switched On . . .

- 1 - Press **⬆** and select **⚙ Setup** and press **OK**.
- 2 - Select **Network settings** and press **OK**.
- 3 - Select **Digital Media Renderer - DMR** and press **OK**.
- 4 - Select **On** and press **OK**.
- 5 - Press **⬆**, repeatedly if necessary, to close the menu.

### TV network name

If you have more than one TV in your home network, you can rename the TV in Network settings.

To rename your TV . . .

- 1 - Press **⬆** and select **⚙ Setup** and press **OK**.
- 2 - Select **Network settings** and press **OK**.
- 3 - Select **TV network name** and press **OK** to show the current name. You can use the keyboard on the remote control to change the TV network name.
- 4 - Select **Done** and press **OK** when ready.
- 5 - Press **⬆**, repeatedly if necessary, to close the menu.

---

## Download the App

The MyRemote app is available for mobile devices running Apple iOS or Android.

### Apple iPhone

To download the app on your iPhone, go to the Apple App Store and look for the **Philips MyRemote** app.



### Apple iPad

To download the app on your iPad, go to the Apple App Store and look for the **Philips MyRemote HD** app.



### Android

To download the app on your Android device, go to the Android Market and look for the **Philips MyRemote** app.



In the MyRemote home menu you can find the following functions . . .

- SimplyShare
- Net TV
- Control

If you have a tablet, you also find . . .

- TV guide

## PHILIPS



**SimplyShare**

Philips TV



**Net TV**

Philips TV



**TV Guide**

No guide found yet



**Control**

Select your device



**PhilipsTV**

2x11h2



Refresh device list

Information

Setup

---

## MyRemote home menu

When you download the MyRemote app, it will appear on the home menu of your smartphone or tablet. Tap the icon of MyRemote to start.

## SimplyShare

With **SimplyShare**, you can send media files (photos, music or videos) from a device in your home network to another.



To open SimplyShare in the MyRemote app, tap the **SimplyShare** button in the home menu.

### Select a device to send media from

- 1 - Tap the white bar at the top to open the list of available devices.
- 2 - Tap a device in the list.

### Select a device to play the media

- 1 - Tap the white bar at the bottom to open the list of available devices.
- 2 - Tap a device in the list.

### Select a media file

You can select the type of media you are looking for - **Music**, **Videos** or **Photos**.

- 1 - Tap the type of media you are looking for.
- 2 - In the list, tap the song, video or photo to play it on the device you selected.

### Compatible media formats

A wide range of media formats can be played on your TV.

In **Help**, press **≡ List** and look up **Playback formats** for the list of compatible file formats for TV.

---

## Net TV

With the Net TV button in the MyRemote home menu, you can open Net TV / Smart TV on your TV.



To open Net TV / Smart TV on your TV, tap the **Net TV** button in the MyRemote home menu.

You can use the remote control of the MyRemote app to browse the pages. With the MyRemote app keyboard, you can easily enter text on TV.

---

## TV guide

If you have a tablet, you can call up the TV guide of your TV on your tablet. You can consult the TV schedule and read programme info. You can tap the programme title to switch to the TV channel directly.



To open the TV guide, tap the TV guide button on the MyRemote home menu. The first time you tap the TV guide button, you will be asked to link up the tablet and TV.

### Preparation

Before you link tablet and TV, check if the TV guide is updated from the Internet.

- 1 - Press **⬆** and select **⚙ Setup** and press **OK**.
- 2 - Select **TV settings > General settings > TV guide**.
- 3 - Select **From the Internet** and press **OK**.
- 4 - Press **⬆**, repeatedly if necessary, to close the menu.

### Link up with the TV

To link up the tablet with the TV guide of the TV . . .

- 1 - Press **GUIDE** on the remote control to open the TV guide on TV.
  - 2 - Press the **■** (yellow) key to open the list of detected mobile devices.
  - 3 - Select the device in the list and press **OK** to view the code to link up.
  - 4 - On the tablet, start the MyRemote App and tap the **Setup** button on the home menu.
  - 5 - Tap the **TV guide** item.
  - 6 - Enter the code to link up.
- 

## Control

With the Control button on the MyRemote home menu, you turn your smartphone or tablet into a full remote control for your TV.



Tap the **Control** button to select your TV (or your Philips Blu-ray Disc player or Home Theatre System) to operate. Tap the device icon to show its remote control.

---

## Future updates

Keep track of the MyRemote App software updates on the app stores.

A future update will have the **Wi-Fi smart screen** function. With this function, you can bring up digital TV channels on your smartphone or tablet.

# Skype

## What is Skype?

With **Skype™** you can make video calls on your TV for free. You can call and see your friends from anywhere in the world. Talk to your friends while watching them on the big screen of your TV.



To make a video call on Skype, you need the separately sold **Philips PTA317** TV camera with a built-in microphone and a good connection to the Internet.

The TV needs to be connected to the Internet before you can set up Skype. You can connect your TV either wireless or wired.

In **Help**, press **≡ List** and look up **Network, wireless** to connect the TV to your home network and the Internet.

### Skype account

To use Skype, you need to create a Skype account for yourself or for your family. You can create a new account for Skype on your TV or on your computer.

### Skype Credit or Skype Subscriptions

With Skype, for a little cost, you can also call phones or mobile phones. Using your computer you can buy Skype Credit or take a Skype subscription at [www.skype.com](http://www.skype.com)

## Start Skype

### Install the camera

Connect the TV camera cable to one of the USB connections on the side or on the back of the TV.

Bend the small clamp as shown in the illustration below and position the camera on the top of the TV.

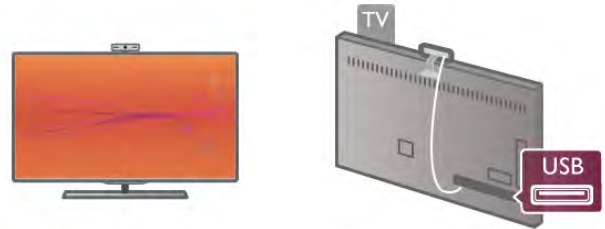

Point the camera to the position you usually sit at. In the Skype settings, you can test the camera, check its viewpoint or set the zoom level.

You can position the camera anywhere you want but it is recommended to put it away from the speakers of the TV.

If the TV camera is not connected, Skype will not start.

## Sign in - New account

With the TV connected to the Internet and the TV camera in place, you can start Skype on your TV.

To open the Skype sign-in page, press **⬆** to open the Home menu, select **Skype** and press **OK**.

Enter your **Skype Name** and **Password**, select **Sign in** and press **OK**. The Skype menu opens on screen.

### Forgotten your Skype name or password?

Start Skype on your computer to get a temporary password from Skype.

### Create a new account

If you do not have a Skype Name and Password yet, you can create a new account in the sign-in page on TV.

- 1 - On the sign-in page, select **New account** and press **OK**.
- 2 - Create your new account.
  - **Full name**  
Enter your full name.
  - **Skype name**  
Enter a name as your Skype name. Your Skype Name will be shown in the list of contacts of other Skype users. A Skype Name must begin with a letter, upper or lowercase. It must have 6 to 32 characters and can contain numbers. A Skype Name cannot contain a space.
  - **Password**  
Enter your password. Your password must have 6 to 20 characters and must at least contain one letter or one number. It cannot contain special characters like a trademark, bullet or euro sign. A Skype password cannot contain a space.
  - **Email**  
Enter your email address.
- 3 - Read and accept the Skype **Terms of Use**.
- 4 - If your new account was accepted, you are signed in.

You can edit or complete your **Skype profile** on your computer. Start Skype on your computer, sign in with your Skype Name and Password and open your Skype profile. You can change your profile picture, add a mood message or set the privacy settings.

---

## No emergency calls



**No emergency calls** - Skype is not a replacement for your telephone and cannot be used for emergency calling.

---

7.3

## Contacts

---

### Contacts page

On the  **Contacts** page you can find your list of Skype contacts. The contacts are shown with their Skype Name. On this page, you can add, block or delete contacts. You can view contact details or view the history of calls you had with this contact.

#### Contact info

To view the details of a contact, select a contact and press  **INFO**.

#### Contact history

To view the calls you had with a contact, press  **Contact history**.

When you sign in with another Skype account on this TV, the history of all contacts of your account is cleared.

#### Online status

To know if a contact is online, check the online status icon next to the Skype Name of your contact. Like all users, your online status is also shown in their contacts page. But also like other users, you can change your online status.

**1** - On the Contacts page, press  **OPTIONS** and select **Online status**.

**2** - In the list, select a status and press **OK**.

Each time you switch the TV on, your status is switched back to **Online**.



#### - Online

This is your usual setting when you sign into Skype. Your contacts can see that you are online and can contact you.



#### - Away

Your contacts can see that you are signed in but not necessarily watching TV. Your contacts can still try to call you.



#### - Do not disturb

Your contacts can see that you are online but you do not wish to be disturbed. They can call you and you will be alerted with sound.



#### - Invisible

You will appear to be offline to all of your contacts, but you can still use Skype as usual. You can use Skype without being disturbed by incoming calls.



#### - Offline

Automatically shown when you are not signed in to Skype. You can also set your status to offline yourself.

#### Phone or mobile numbers

You can also add a phone number of a landline phone or mobile phone to your list of contacts. Such a contact will be marked with this icon.



---

## Add a contact

If you know the Skype Name or email of a friend, you can easily add them to your list of contacts. If you do not know their Skype Name or email, you can also try to look for them by name.

**1** - In the menu bar select the  **Contacts** page. You can press  **LIST** or  to jump to the menu bar.

**2** - Press  **Add contact**.

**3** - In the text field, enter a Skype name, email address or name. Use the key pad on the remote control to enter the text.

**4** - Select **Search** and press **OK**.

**5** - Skype will find users that match your search. To know if you selected the person you are looking for, press  **INFO** for the contact details.

**6** - If this is the person you are looking for, select **Add** and press **OK**.



The newly added contact has to accept your request to add his or her name to your list of contacts. Until the contact accepts your request, the new contact appears offline.



#### Accepting a Contact request

Other Skype users can invite you to be on their contact list. You will be notified of their request, which you can accept or decline.

---

## Block a contact

You can block any Skype user from finding you online. A blocked contact will be unable to contact you with Skype. A blocked contact will not be notified, you will always appear to be offline in the contact list of the blocked contact.

On the  **Contacts** page, select a contact and press  **Block contact**.

You can always unblock a contact. To unblock, select the contact in the list and press  **Unblock contact**.



In the list of contacts a blocked contact has this icon.

To view a list of blocked contacts, press  **OPTIONS** and select **Blocked contacts**.

To unblock someone in the list, select the name and press **OK**.

---



7.4

## Calling on Skype

### Video and voice call

With Video call you can call and see your friends on your TV screen, for free.





#### Make a Video call

On the  **Contacts** page, select the person you want to call and then select the  **Video call** button and press **OK**.

If your contact has a camera connected and accepts the call, you can see the person on your TV, full screen. When your TV camera is switched on, the blue indicator LED lights up. You can check what your contact can see, in the small screen on your TV.

To mute your microphone while you are making the call, press  **Mute**.

To switch off your camera, press  **Camera off**.

To zoom and frame the camera, press  **Zoom**. Now, you can press  **Zoom out** or press  **Zoom in**. You can use the arrows to frame the camera. When the zoom and framing is fine for you, press  **Set zoom**.

To end a call, select the **End call** button and press **OK**.

#### Make a Voice call

You can make a Skype call without video, with the camera switched off.

To make a call without video, select the contact, then select the  **Voice call** button and press **OK**.

To mute your microphone while you are calling, press  **Mute**.

To end the voice call, select the **End call** button and press **OK**.



On a voice call, you can still switch to a Video call. To switch to Video call, press  **Camera on**.

A contact can add you to a voice call with more than one participant. You cannot add an extra participant yourself.

### Camera and microphone

The volume of the microphone is set to its ideal setting automatically.

You can test your camera with built-in microphone to see if it is working.



Press  **LIST** to jump to the menu bar, select  **Settings** in the menu bar and select **Test camera and microphone**.

---

## Calling phones and mobiles

With Skype you can also call landline phones and mobile phones. To call phones you need to buy Skype Credit on Skype on your computer. You can buy Skype Credit or subscribe to a Skype subscription.

### Call a phone

**1** - Select  **Call phones** in the menu bar. You can press  **LIST** to jump to the menu bar.

**2** - Enter the telephone number with the remote control keys or select the numbers on the dial pad on screen.

To enter a + (plus), press  **+**.

To enter a \* (asterisk), press  **\***.

To enter a # (hash), press  **#**.

To delete one digit, press  **Backspace**.

**3** - When you entered the complete number, select the **Call** button and press **OK** to start calling.

To mute your microphone while you are calling, press  **Mute**.

To end a phone call, select the **End call** button and press **OK**.

### List of recently called phones

If you have called some phones with Skype earlier, you can select a phone number in the list at the left of the page.

To clear the selected phone number, press  **Clear number**.

To add this phone number to your list of contacts, press  **Add to contacts**.

To clear all phone numbers, press  **Clear all**.



**No emergency calls** - Skype is not a replacement for your telephone and cannot be used for emergency calling.

---

## Receiving a call

When you are signed in to Skype and watching TV, you are notified of an incoming call with a message on screen. The notification says who is calling and you can accept or decline the call.

To accept the call, select the **Answer** button in the notification and press **OK**.

To decline, select the **Decline** button and press **OK**.



Also, new contact requests will be shown immediately.

### Skype during rental movies and Pause TV

While you are watching a rental movie from a broadcaster or video store, or using Pause TV, accepting a Skype call will interrupt the movie or paused programme.

To resume watching the rental movie, you need to go back to the video store or broadcast service. Some video stores and services do not allow you to restart the movie. The Pause TV programme storage is lost.

### Skype during recording

While recording a programme on a connected USB Hard Drive, the TV will notify you if there was an incoming call and from who it was. The TV prevents accepting a Skype call during recording. You can easily answer the call from the  **Recent** page, after the recording is done.

### Contact notifications

Next to normal calls, you can be notified when your contacts come online or go offline. You can switch off these contact notifications on the  **Settings** page.

---

## Recent calls

On the  **Recent** page, you can view your recent Skype events.

The most recent Skype event is shown first. It shows which contact, the type of event - video call or Phone call and when it occurred.

As on the Contacts page, you can make a Video call, Voice call or Phone call to a selected contact.

### History

For how long your Skype events are kept in this history list depends on the amount of contacts you have and how intensively you use Skype.

Also, if you sign in with another Skype account on this TV, the recent history will be cleared.



---

## Voicemail



If someone calls you on Skype and you cannot take the call, he or she can leave a spoken message on your Skype voicemail.

To leave a message on a contacts voicemail, you need to set up Skype voicemail on your computer.

If you did not setup voicemail for yourself but the contact who called has setup voicemail, he or she can leave a voicemail for you.

On the  **Voicemail** page, you can play voicemail messages that were left for you. If a number is shown next to the voicemail icon in the menu bar, you have a new voicemail message -  1.

### Play a voicemail

To play a voicemail, select the voicemail icon  in the menu bar, select the new voicemail in the list and press **OK**. You can listen to the new voicemail as many times you want. However, when you leave the  **Voicemail** page, all played voicemails are removed from the list.

As on the Contacts page, you can make a Video call, Voice call or Phone call to a selected contact.

---

7.5

## Skype Credit

On Skype, you can buy **Skype Credit** or take a **Skype subscription**. With Skype Credit or a Skype subscription available, you can call landline phones and mobile phones with your TV.

### Buy Skype Credit

To buy Skype Credit or take a Skype subscription, sign in to Skype on your computer.

The Skype Credit you buy will be available when you sign in to Skype on your TV.

The amount of credit or the subscription information is shown on each page where you can make a phone call.

### Skype Credit low

You will be notified if your credit is too low to make a phone call.

---

7.6

## Skype settings

---

### Automatic sign-in

You can set Skype to automatically sign in when you switch on the TV. You do not need to enter your Skype Name or password.

Navigate to the menu bar and select  **Settings** to open the Settings page.

Select **Automatic sign-in** and press **OK** to check or uncheck.

---

### Contact notifications

You can receive or block the online status notifications of your contacts while you watch TV.

Navigate to the menu bar and select  **Settings** to open the Settings page.

Select **Contact notifications** and press **OK** to check or uncheck.

---

### Online status

You can change your own online status.

Navigate to the menu bar and select **Settings** to open the Settings page.  
Select **Online status** and then select the online status you want your contacts to see when you are online and press **OK**.

---

## Ringtone volume

You can adjust the Skype ringtone volume.

Navigate to the menu bar and select **Settings** to open the Settings page.  
Select **Ringtone volume** and then adjust the volume with the arrows up and down.

---

## Test camera and microphone

You can test if your Skype camera and microphone work. Also you can zoom and frame the picture of your camera to exactly what you want your contacts to see.

Navigate to the menu bar and select **Settings** to open the Settings page.  
Select **Test camera and microphone**. The picture of the camera should appear and when you talk, the microphone volume should indicate your voice.

### Zoom and frame the picture

- 1 - Press **Zoom out** or **Zoom in**.
- 2 - With the picture zoomed in, you can shift the camera frame up, down, left or right to exactly frame the picture. Use the arrows on the remote control to shift.
- 3 - Press **Set zoom** when done.

The volume of the microphone is adjusted automatically.

---

## Change password

You can change your current Skype password and enter a new password.

- 1 - Navigate to the menu bar and select **Settings** to open the Settings page.
  - 2 - Select **Change password**.
  - 3 - Select the **Current password** text field to enter your password.
  - 4 - Select the **New password** text field and enter a new password.
  - 5 - Select the **Repeat new password** text field and enter the new password again.
  - 6 - Press **OK** to send the new password for confirmation.
- 

7.7

## Sign out

Navigate to the menu bar and select **Settings** to open the Settings page.

Select **Sign out** to quit Skype on your TV.

7.8

## Terms of Use

Read the Terms of Use of Skype at [www.skype.com/go/tou](http://www.skype.com/go/tou)

Also read the Privacy Statement at [www.skype.com/privacy](http://www.skype.com/privacy)

# Games

## 8.1

### Play a game

With a game console connected to the TV, you can play games on TV.

#### Start a game

Switch on the game console and press **⬆️**, select the icon you have set for your game console (e.g. Game or Player) and press **OK** to view the game.

#### Ideal game setting

For some games, where speed and precision is needed, set the TV to the ideal **Game** setting before you start playing. If your game console is added as a **Game** type of device in the Source menu (list of connections), the TV is set to the ideal **Game** setting automatically. If the type of your game console is set as **Player** and used as a disc player most of the time, leave the device type set to **Player**.

To set the TV to the ideal setting manually . . .

- 1 - Press **⬆️**, select **⚙️ Setup** and press **OK**.
- 2 - Select **TV settings > Picture > Game or computer** and press **OK**.
- 3 - Select **Game** and press **OK**.
- 4 - Press **➡️**, repeatedly if necessary, to close the menu. Remember to set the Game or computer setting back to **Off** when you stop playing the game.

In **Help**, press **☰ List** and look up **Game console, connect** to connect a game console to the TV.

## 8.2

### Two-player games

If you play a multi-player game with split screens, you can set the TV to show each screen as a full screen. Each player sees only his part of the game, full screen. The TV uses 3D technology to show both screens.



#### What you need

To play a two-player game with this TV, you need 2 active 3D glasses - Philips PTA507 or PTA517 (sold separately). Also, the game console must be connected with HDMI.

#### Start a two-player game

- 1 - Press **➡️ Source**, select the game console and press **OK**.

2 - On the game console, start the game and select the multi or two-player mode. Select the mode for split screen viewing.

3 - On the TV, press **≡ OPTIONS**, select **🖥️ Picture and sound**, select **Two-player gaming** and press **OK\***.

4 - Select the format in which the split screen game is shown on screen, **Side by side** or **Top / bottom** and press **OK**. The TV shows the 2 screens as full screens.

To watch the 2 different screens, put on the 3D glasses.

To switch the glasses to watch the Player 1 screen or Player 2 screen, press the Player 1/2 selection key on the glasses.

#### In and out of split screen view

In two-player split screen view, you can switch back and forth from split screen to combined view, to be able to read the game menu or game scores.

To switch views back and forth, press **OK** on the remote control of the TV.

#### Stop a Two-player game

To stop the two-player split screen view, press **⬆️** and select another activity.



\* If Two-player gaming is unavailable in the menu, press **3D** on the remote control and select **2D** and press **OK**.

# TV Specifications

## Environmental

### Saving energy

Energy saving bundles the TV settings that help the environment.

While you are watching TV channels, press  to open **Eco settings**. Active settings are marked with a . Press  again to close.

#### Energy saving

This Smart picture setting sets the picture, together with Ambilight, in the most ideal energy conscious setting. To switch on, select **Energy saving** in Eco settings and press **OK**. To switch off Energy saving, select another Smart picture setting.

#### Screen off

If you only listen to music, you can switch off the TV screen to save energy. Select **Screen off** and press **OK**. To switch the screen back on, press any key on the remote control.

#### Light sensor

To save energy, the built-in ambient light sensor lowers the brightness of the TV screen when the surrounding light darkens. The built-in light sensor automatically adjusts the picture, together with Ambilight, to the lighting conditions of the room. To switch on, select **Light sensor** and press **OK**. To switch off, press **OK** again.

#### Switch off timer

If you do not press a key on the remote control during a 4 hour period, or if the TV receives no signal for 10 minutes, the TV switches off automatically to save energy. Select **Switch off timer**.

If you use the TV as a monitor or use a digital receiver to watch TV (a Set-top box - STB) and you do not use the remote control of the TV, deactivate the automatic switch off.

In addition to these eco settings, your TV also has environmentally friendly adjustments with regard to power consumption.

#### Low standby power

The class-leading and highly advanced power circuitry brings down the power consumption of the TV to an extremely low level, without losing out on the constant Standby functionality.

#### Power management

The advanced power management of this TV ensures the most efficient use of energy. You can check how your personal TV settings, the level of brightness in current onscreen pictures, and the surrounding light conditions determine the relative power consumption.

To check the relative power consumption, press  > **Setup** > **Watch demos** > **Active control** and press **OK**. Select a setting to check the corresponding values.

### European energy label

The **European Energy Label** informs you on the energy efficiency class of this product. The greener the energy efficiency class of this product is, the lower the energy it consumes.

On the label, you can find the energy efficiency class, the average power consumption of this product in use and the average energy consumption for 1 year. You can also find the power consumption values for this product on the Philips website for your country at [www.philips.com/TV](http://www.philips.com/TV)

### Eco-label

Philips continuously focuses on lowering the environmental impact of its innovative consumer products. We aim our efforts towards environmental improvements during manufacturing, reduction of harmful substances, energy-efficient use, end-of-life instructions and product recycling.



Thanks to our environmental effort, this TV has been awarded the **European Ecolabel** – the flower – ([www.ecolabel.eu](http://www.ecolabel.eu)). You can find detailed information on standby energy consumption, warranty policy, spare parts and recycling of this TV on the Philips website for your country at [www.philips.com](http://www.philips.com)

### End of use

#### Disposal of your old product and batteries

Your product is designed and manufactured with high quality materials and components, which can be recycled and reused.



When this crossed-out wheeled bin symbol is attached to a product it means that the product is covered by the European Directive 2002/96/EC.



Please inform yourself about the local separate collection system for electrical and electronic products.

Please act according to your local rules and do not dispose of your old products with your normal household waste. Correct disposal of your old product helps to prevent potential negative consequences for the environment and human health.

Your product contains batteries covered by the European Directive 2006/66/EC, which cannot be disposed with normal household waste.



Please find out for yourself about the local rules on separate collection of batteries because correct disposal will help to prevent negative consequences for the environment and human health.

---

9.2

## Power

Product specifications are subject to change without notice. For more specification details of this product, see [www.philips.com/support](http://www.philips.com/support)

### Power

- Mains power : AC 220-240V +/-10%
- Ambient temperature : 5°C to 35°C
- Standby power consumption : < 0.15W
- Power saving features : Light sensor, Eco mode, Picture mute (for radio), Auto switch-off timer, Eco settings menu.

### Energy label class

- 40PFL8007 : class **A**
- 46PFL8007 : class **A**
- 55PFL8007 : class **A+**

The power rating stated on the product typeplate is the power consumption for this product during normal household use (IEC 62087 Ed.2). The maximum power rating, stated between brackets, is used for electrical safety (IEC 60065 Ed. 7.2).

---

9.3

## Reception

- Aerial input : 75 ohm coaxial (IEC75)
- Tuner bands : Hyperband, S-Channel, UHF, VHF
- DVB : DVB-T (terrestrial, antenna) COFDM 2K/8K, DVB-T2 : only for TV types '... T/12', DVB-C (cable) QAM
- Analogue video playback : NTSC, SECAM, PAL
- Digital video playback : MPEG2 SD/HD (ISO/IEC 13818-2), MPEG4 SD/HD (ISO/IEC 14496-10)
- Digital audio playback (ISO/IEC 13818-3)
- See selected countries on the TV type plate
- Satellite aerial input : 75 ohm F-type
- Input frequency range : 950 to 2150MHz
- Input level range : 25 to 65 dBm
- DVB-S/S2 QPSK, symbol rate 2 to 45M symbols, SCPC and MCPC
- Preset for satellites : Astra (19.2°E), Astra (23.5 °E), Astra (28.2 °E), Hotbird (13.0 °E), TürkSat (42.0 °E)
- Astra HD+ support

- LNB : DiSEqC 1.0, 1 to 4 LNBs supported, Polarity selection 14/18V, Band selection 22kHz, Tone burst mode, LNB current 300mA max
- See selected countries on the TV type plate

---

9.4

## Display

### Type

- Display type : LED Full HD
- Diagonal screen size :
  - 40PFL8007 : 102 cm / 40 inch
  - 46PFL8007 : 117 cm / 46 inch
  - 55PFL8007 : 140 cm / 55 inch
- Panel resolution : 1920x1080p
- 3D : 3D Max Clarity 700, Two-player Full Screen gaming, 3D Depth adjustment, 2D to 3D conversion
- Aspect ration : 16:9
- Brightness : 450 cd/m<sup>2</sup>
- Peak Luminance ration : 65%
- Dynamic screen contrast : 500.000 : 1
- Picture enhancement : Pixel Precise HD, 800Hz Perfect Motion Rate, Micro Dimming

---

## Display resolutions

### Video formats

Resolution — Refresh rate

- 480i - 60 Hz
- 480p - 60 Hz
- 576i - 50 Hz
- 576p - 50 Hz
- 720p - 50 Hz, 60 Hz
- 1080i - 50 Hz, 60 Hz
- 1080p - 24 Hz, 25 Hz, 30 Hz
- 1080p - 50 Hz, 60 Hz

### Computer formats

Resolutions (amongst others)

- 640 × 480p — 60 Hz
- 800 × 600p — 60 Hz
- 1024 × 768p — 60 Hz
- 1280 × 768p — 60 Hz
- 1360 × 765p — 60 Hz
- 1360 × 768p — 60 Hz
- 1280 × 1024p — 60 Hz
- 1920 × 1080i — 60 Hz
- 1920 × 1080p — 60 Hz

---

9.5

## Sound

- Output power (RMS) : 40W (2x20W) @30%THD
- Sound enhancement : Auto Volume Leveller, Clear Sound, Incredible Surround
- Loudspeaker types : Soundstage stand enclosure

## Multimedia

### Connections

- USB 2.0
- Ethernet LAN RJ-45
- Wi-Fi 802.11b/g/n (built-in)

### Supported USB file systems

- FAT 16, FAT 32, NTFS

### Playback formats

- Containers : 3GP, AVCHD, AVI, DivX®, MPEG-PS, MPEG-TS, MPEG-4, Matroska (MKV), Quicktime (MOV), Windows Media (ASF/WMV/WMA)
- Video Codecs : DivX®, MPEG-1, MPEG-2, MPEG-4 Part 2, MPEG-4 Part 10 AVC (H264), VC-1, WMV9
- Audio Codecs : AAC, HE-AAC (v1/v2), AMR-NB, Dolby Digital, Dolby Digital Plus, MPEG-1/2/2.5 Layer I/II/III (includes MP3), WMA (v2 to v9.2), WMA Pro (v9/v10)
- Subtitles :
  - Formats : SAMI, SubRip (SRT), SubViewer, DivX® subtitles
  - Character encodings : UTF-8, Central Europe and Eastern Europe (Windows-1250), Cyrillic (Windows-1251), Greek (Windows-1253), Western Europe (Windows-1252)
- Image Codecs : JPEG
- Limitations :
  - Maximum supported total bit rate for a media file is 30Mbps.
  - Maximum supported video bit rate for a media file is 20Mbps.
  - MPEG-4 AVC (H.264) is supported up to High Profile @ L4.1.
  - VC-1 is supported up to Advanced Profile @ L3.

### DivX®

In **Help**, press **≡ List** and look up **DivX® VOD** for more information.

### Supported DLNA media server software (DMS)

- PC - Microsoft Windows XP, Vista or Windows 7
  - PacketVideo - Twonky Media
  - PacketVideo - TwonkyManager
  - Microsoft - Windows Media Player
- Mac OS X
  - PacketVideo - TwonkyServer
  - PacketVideo - TwonkyManager
- Mobile devices
  - Philips MyRemote - iOS, Android
  - Interoperability and performance may vary, depending on the capabilities of the mobile device and the software used.

### ESD regulations

This apparatus meets performance criteria A for ESD. In case the apparatus does not recover in DLNA mode due to electrostatic discharge, user interference is required.

- VGA (D-sub 15), Audio In (stereo mini-jack 3.5mm)
- Audio In (DVI to HDMI / VGA) (stereo mini-jack 3.5mm)
- 3x HDMI in with ARC (3D)
- USB
- Network LAN — (RJ45)

### TV Side

- 2x HDMI Side in with ARC (3D)
- 2x USB
- Audio Out L/R — display synchronised (optical)
- Common interface slot (CI+/CAM)
- Headphones (stereo mini-jack 3.5mm)

## Dimensions and weights

### 40PFL8007

Width 910 mm  
 Height 524 mm  
 Depth 31 mm  
 Weight ±11 kg  
 . . . with TV stand  
 Height 590 mm  
 Depth 206 mm  
 Weight ±14 kg

### 46PFL8007

Width 1042 mm  
 Height 599 mm  
 Depth 31 mm  
 Weight ±14 kg  
 . . . with TV stand  
 Height 665 mm  
 Depth 206 mm  
 Weight ±17 kg

### 55PFL8007

Width 1235 mm  
 Height 706 mm  
 Depth 31 mm  
 Weight ±17 kg  
 . . . with TV stand  
 Height 772 mm  
 Depth 241 mm  
 Weight ±21 kg

UMv 3104 327 0070.4 - 120511

## Connectivity

### TV Rear

- SCART (adapter included): Audio L/R, CVBS in, RGB
- YPbPr : Y Pb Pr (adapter included), Audio L/R)

# TV Software

## Software version

To view the current TV software version, press **Home**, select **Setup** and press **OK**.

Select **Software settings** and press **OK**.

Select **Current software info** and see **Version: . . . .**

## Software update

### Software update from Internet

If the TV is connected to the Internet, you may receive a message from TP Vision to update the TV software. You need a high-speed (broadband) Internet connection.

If you receive this message, we recommend you carry out the update. Select **Update**. Follow the instructions on screen.

You can also look for new updates yourself.

To look for an update, press **Home**, select **Setup** and press **OK**.

Select **Update software** and press **OK**. Follow the instructions on screen.

When the update is complete, the TV switches off and back on again automatically. Wait for the TV to switch itself back on. Do not use the Power switch **Power** on the TV.

### Software update from USB

It might be necessary to update the TV software. You need a computer with an high-speed Internet connection and a USB memory device to upload the software on the TV. Use a USB memory device with 256MB free space. Make sure that write protection is switched off.

#### 1 - Start the update on TV

To start the software update, press **Home**, select **Setup** and press **OK**.

Select **Update software > USB** and press **OK**.

#### 2 - Identify the TV

Insert the USB memory into the side of the TV, select **Start** and press **OK**. An identification file is written on the USB memory device.

#### 3 - Download the TV software

Insert the USB memory into your computer. On the USB memory device, locate the file **update.htm** and double click it. Click on **Send ID**. If new software is available, download the .zip file. After the download, unzip the file and copy the file **autorun.upg** onto the USB memory device. Do not place this file in a folder.

#### 4 - Update the TV software

Insert the USB memory into the TV again. The update starts automatically. The TV switches itself off for 10 seconds and then back on again. Please wait.

**Do not . . .**

- use the remote control
- remove the USB memory device from the TV

If a power cut occurs during the update, never remove the USB memory device from the TV. When the power returns, the update will continue.

At the end of the update, the message **Operation successful** appears on screen. Remove the USB memory device and press **Power** on the remote control.

**Do not . . .**

- press **Power** twice
- use the **Power** switch on the TV

The TV switches itself off (for 10 seconds) and then back on again. Please wait.

The TV software has been updated. You can use the TV again.

To prevent an accidental update of the TV software, delete the **autorun.upg** file from the USB memory device.

## Open source software

This television contains open source software. TP Vision Netherlands B.V. hereby offers to deliver, upon request, a copy of the complete corresponding source code for the copyrighted open source software packages used in this product for which such offer is requested by the respective licences.

This offer is valid up to three years after product purchase to anyone in receipt of this information. To obtain the source code, please contact **open.source@philips.com**

If you prefer not to use email or if you do not receive a confirmation receipt within a week after mailing to this email address, please write in English to . . .

#### Open Source Team

TP Vision Netherlands B.V.  
High Tech Campus 5  
5656 AE Eindhoven  
The Netherlands

## Open source license

# Support

## 11.1

## Register

Register your TV and enjoy a range of benefits including full support (including downloads), privileged access to information about new products, exclusive offers and discounts, the chance to win prizes and even participate in special surveys about new releases.

Go to [www.philips.com/welcome](http://www.philips.com/welcome)

## 11.2

## Using help and search

This TV offers help on screen.

You can find the information you are looking for in the list of topics or read the Help as a book with chapters.

### Open Help



Press  to open the Home menu.

Select  **Help** and press **OK**.

To view an alphabetical list of topics, select the  **List** tab in the menu bar.

To read the Help as a book, select  **Book** in the menu bar.

Before you execute the Help instructions, close Help.

To close Help, press  or .

On most settings and options in menus, you can press  (blue key) to read some information on the selected setting or option.

If information on the setting or option is available, you can press  (blue key) again to open the relevant page in Help.

For some activities, like Text, the colour keys have specific functions and cannot open Help.

### TV Help on your tablet, smartphone or computer

You can download the TV Help in PDF format to read on your smartphone, tablet or computer.

To carry out extended sequences of instructions more easily, you can print out the relevant Help page from your computer.

To download the Help (user manual) go to [www.philips.com/support](http://www.philips.com/support)

## 11.3

## Online support

To solve any Philips TV related problem, you can consult our online support. You can select your language and enter your product model number.

Go to [www.philips.com/support](http://www.philips.com/support) .

On the support site you can find your country's telephone number to contact us as well as answers to frequently asked questions (FAQs).

You can download new TV software or the manual to read on your computer. You can email a specific question or, in some countries, chat online to one of our collaborators.

## 11.4

## Consumer Care

For support, you can call the Consumer Care hotline in your country. Find the telephone number in the printed documentation that came with the TV.

Or consult our website [www.philips.com/support](http://www.philips.com/support) .

### TV model number and serial number

You might be asked to provide the TV product model number and serial number. Find these numbers on the packaging label or on the type label on the back or bottom of the TV.



# Copyrights and licences

## HDMI



### HDMI®

The terms HDMI and HDMI High-Definition Multimedia Interface, and the HDMI Logo are trademarks or registered trademarks of HDMI Licensing LLC in the United States and other countries.

## Dolby



### Dolby®

Manufactured under license from Dolby Laboratories. Dolby and the double-D symbol are trademarks of Dolby Laboratories.

## Skype



Skype™ is a trademark of Skype™ Limited or its related companies.

## DivX



**ABOUT DIVX VIDEO:** DivX® is a digital video format created by DivX, LLC, a subsidiary of Rovi Corporation. This is an official DivX Certified® device that plays DivX video. Visit [divx.com](http://divx.com) for more information and software tools to convert your files into DivX videos.

**ABOUT DIVX VIDEO-ON-DEMAND:** This DivX Certified® device must be registered in order to play purchased DivX Video-on-Demand (VOD) movies.

To obtain your registration code, locate the DivX VOD section in your device setup menu. Go to [vod.divx.com](http://vod.divx.com) for more information on how to complete your registration.

## Microsoft

### Windows Media

Windows Media is either a registered trademark or trademark of Microsoft Corporation in the United States and/or other countries.

### Microsoft PlayReady

Content owners use Microsoft PlayReady™ content access technology to protect their intellectual property, including copyrighted content.

This device uses PlayReady technology to access PlayReady-protected content and/or WMDRM-protected content. If the device fails to properly enforce restrictions on content usage, content owners may require Microsoft to revoke the device's ability to consume PlayReady-protected content. Revocation should not affect unprotected content or content protected by other content access technologies. Content owners may require you to upgrade PlayReady to access their content. If you decline an upgrade, you will not be able to access content that requires the upgrade.

## Other trademarks

All other registered and unregistered trademarks are the property of their respective owners.

---

# Index

## 3

- 3D glasses, cleaning 42
- 3D glasses, type 42
- 3D glasses, use 42
- 3D, 2D to 3D 43
- 3D, cleaning glasses 43
- 3D, health warning 43
- 3D, optimal viewing 43

## A

- Ambilight colour 35
- Ambilight, dynamic 34
- Ambilight, mode 35
- Ambilight, placement 34
- Ambilight, setup 34
- Ambilight, switch on or off 34
- Ambilight, TV placement 5
- Ambilight, TV switch off 35
- Antenna connection 5
- Antenna connection, tips 7
- App, feedback 45
- App, gallery 45
- App, lock 45
- App, recommended 45
- App, search 45
- Audio commentary 35
- Audio effects 36
- Audio language 31
- Audio Out - Optical 8
- Audio to video sync 11
- Auto subtitle shift 10
- Automatic channel update 25

## B

- Balance 33
- Black bars 27

## C

- Channel list copy 25
- Channel list copy, copy 26
- Channel list copy, upload 26
- Channel list, New 25
- Channel lists 23
- Channel lock 24
- Channel, favourite 24
- Channel, rename 23
- Channel, reorder 24
- Channel, switch 22
- Channel, update 25
- Channels, reinstall 25
- Child lock code 24
- Clock 31
- Connections, list 29
- Connectivity guide 7

## D

- Device icon 29
- Digital Text 28
- DivX® VOD 48
- DLNA 6
- DLNA, supported media servers 61

- DMR - Digital Media Renderer 7
- DVB 26
- DVI, connect 8

## E

- EasyLink 9
- EasyLink, connections 8
- EasyLink, settings 9
- Eco settings 59
- End of use 59
- ESD 61
- European Ecolabel 59
- European Energy Label 59

## F

- Factory settings 25

## G

- Game console, connect 12
- Game or computer, computer 16
- Game or computer, game 58
- Game, play 58
- Game, two-player 58
- Gamma 32

## H

- HbbTV 28
- HDCP, copy protection 8
- HDMI connection, tips 8
- Headphone volume 33
- Hearing impaired 35
- Help, on a tablet 63
- Help, usage 63
- Home menu 44
- Home Theatre System, multichannel 12
- Home Theatre System, volume levelling 12

## I

- Infrared sensor 21
- Interactive TV 28
- Internet App 45
- Internet memory, clear 7
- ISF Calibration, picture 33
- ISF® Calibration 33

## K

- Key beep 36
- Keyboard, connect 13

## L

- Language, menus 31
- Light sensor 59
- Lounge light 35

## M

- Manual installation 27
- Mixed volume 36
- Mono / Stereo 33
- Mouse, connect 14
- Music files, playback 47
- MyRemote App, about 50

## N

- Network router 6
- Network, DHCP 6
- Network, password 6
- Network, settings 7

- Network, Static IP 6
  - Network, wired 7
  - Network, wireless 5
- O**
- On and off 18
  - Online support 63
  - Online TV 46
  - Open source software 62
  - Options, on a channel 22
  - Original language 31
- P**
- Parental rating 24
  - Pause TV 48
  - Perfect Pixel HD Engine 32
  - Photo camera, connect 14
  - Photos, slideshow 47
  - Picture settings 32
  - Picture style 32
  - Pixel Plus link 10
  - Playback formats 61
  - Pointer, about 20
  - Pointer, use 21
  - Power consumption 59
  - Power inlet 5
  - Preferred audio format 33
  - Programme list 29
- Q**
- Quick start 18
- R**
- Radio channel 22
  - Reception quality 26
  - Recording 49
  - Recordings, home menu 49
  - Reinstall TV 25
  - Reminder, programme 29
  - Remote control keyboard 19
  - Remote control, Azerty 20
  - Remote control, batteries 22
  - Remote control, Keys 19
  - Remote control, pairing 21
  - Rental movies 46
- S**
- Safety instructions 17
  - Satellite channel lists 37
  - Satellite channel lock 38
  - Satellite channel, favourite 38
  - Satellite channel, rename 37
  - Satellite channel, reorder 38
  - Satellite channel, signal 41
  - Satellite channel, switch 37
  - Satellite, add 40
  - Satellite, channel list copy 40
  - Satellite, connection 5
  - Satellite, installation 39
  - Satellite, LNB 39
  - Satellite, remove 40
  - Satellite, troubleshooting 41
  - Satellite, watch 37
  - Saving energy 59
  - SCART connection, tips 8
  - Screen care 17
  - Screen edges 32
  - Screen off, switch 47
  - Setup menu 16
  - Shop location 33
  - Skype 53
  - Skype, automatic sign-in 56
  - Skype, block contact 55
  - Skype, calling phones 55
  - Skype, camera test 57
  - Skype, change password 57
  - Skype, contacts 54
  - Skype, Credit 56
  - Skype, event 56
  - Skype, history 56
  - Skype, mute 55
  - Skype, new account 53
  - Skype, notifications 56
  - Skype, online status 54
  - Skype, receive calls 55
  - Skype, ringtone 57
  - Skype, sign in 53
  - Skype, sign out 57
  - Skype, video call 55
  - Skype, voice call 55
  - Skype, voicemail 56
  - Sleep timer 31
  - Smart TV, PIN code 44
  - Smart TV, register 44
  - Smart TV, start page 44
  - Software, current version 62
  - Software, Internet update 62
  - Software, USB update 62
  - Sound settings 33
  - Sound style 33
  - Source menu 29
  - Speakers / Headphones 36
  - Speech 36
  - Standby 18
  - Standby delay 18
  - Status 23
  - Streaming video 46
  - Subtitles 30
  - Switch off timer 59
  - Synchronize audio and video 11
- T**
- Television on Demand 46
  - Text 27
  - Text, dual screen 28
  - Text, freeze 28
  - Text, options 28
  - Text, setup 28
  - Text, T.O.P. overview 28
  - TV clock 31
  - TV guide 28
  - TV guide, information 29
  - TV placement 34
  - TV stand, loudspeakers 16
- U**
- Universal access 35
  - USB flash drive, connect 14
  - USB Hard Drive, info 13
  - USB Hard Drive, installation 13
  - USB keyboard 14
  - USB mouse 14

## **V**

VESA 16

VGA connection, tips 9

Video files, playback 47

Video store 46

Viewing distance 5

## **W**

Wall colour 35

Wall mounting 16

Watch TV 22

WPS - Wi-Fi Protected Setup 6

WPS, PIN code 6

WWW. 45

## **Y**

YPbPr connection, tips 8



# Contact information

**Argentina**

0800 444 7749  
Buenos Aires 0810 444 7782

**België / Belgique**

070 700 035 (0,15€/min.)

**Bosna i Hercegovina**

033 941 251 (Lokalni poziv)

**Brazil**

0800 701 0245  
Sao Paulo 2938 0245

**България**

02 4916 273 (Национален номер)

**Česká republika**

228880895 (Místní tarif)

**Danmark**

3525 8314

**Deutschland**

0180 501 04 69 (0,14€/Min.)

**Ελλάδα**

2111983028 (Εθνική κλήση)

**España**

902 88 10 83 (0,10€ + 0,08€/min.)

**Estonia**

6683061 (Kohalikud kõned)

**France**

01 57 32 40 50 (local)

**Hrvatska**

01 777 66 01 (Lokalni poziv)

**Italia**

0245 28 70 14 (chiamata nazionale)

**Ireland**

0818 210 140 (national call)

**Northern Ireland**

0844 338 04 88 (5p/min BT landline)

**Қазақстан**

8 10 800 2000 00 04 (free)

**Latvia**

6616 3263 (Vietējais tarifs)

**Lithuania**

8 5 214 0293 (Vietinaiš tarifais)

**Luxembourg / Luxemburg**

2487 1100 (Nationale Ruf / appel national)

**Magyarország**

06 1 700 8151 (Belföldi hívás)

**Nederland**

0900 202 08 71 (0,10€/min.)

**Norge**

22 97 19 14

**Österreich**

0820 40 11 33 (0,145€/Min.)

**Polska**

22 397 15 04 (Połączenie lokalne)

**Portugal**

707 78 02 25 (0,12€/min. - Móvel  
0,30€/min.)

**România**

031 6300042 (Tarif local)

**Россия**

8-800-22 00004 (бесплатно)

**Suisse / Schweiz / Svizzera**

0848 000 291 (0,081 CHF/Min.)

**Србија**

011 321 6840 (Lokalni poziv)

**Slovakia**

2 332 154 93 (Vnútroštátny hovor)

**Slovenija**

1 888 83 12 (Lokalni klic)

**Suomi**

09 88 62 50 40

**Sverige**

08 5792 9096 (lokalsamtal)

**ประเทศไทย (Thailand)**

02 652 7650

**Türkiye**

444 8 445

**United Kingdom**

0844 338 04 88 (5p/min BT landline)

**Україна**

0-800-500-480 (безкоштовно)

[www.philips.com/support](http://www.philips.com/support)

Non-contractual images / Images non contractuelles / Außervertragliche Bilder



Specifications are subject to change without notice.

Philips and the Philips' shield emblem are registered trademarks of Koninklijke Philips Electronics N.V. and are used under license from Koninklijke Philips Electronics N.V.

All registered and unregistered trademarks are property of their respective owners.

2012 © TP Vision Netherlands B.V. All rights reserved.

[www.philips.com](http://www.philips.com)