

# 1 Connect

## A Placement

Proper speakers system placement is important to ensure optimum sound performance.

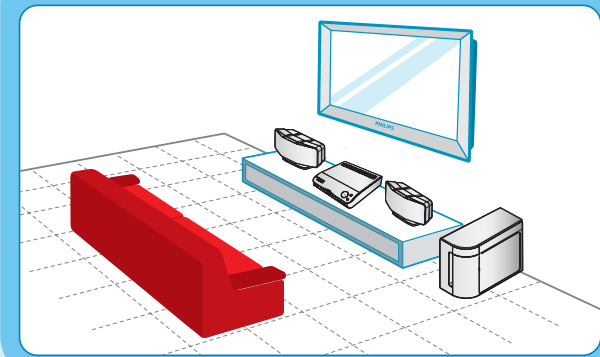

- 1 Place the SonoWave speakers at the normal listening ear level, equal distance from the TV and face straight ahead towards the listening area.
- 2 Place the subwoofer on the floor, at least one meter away from the TV.

## B Connect the radio antennas

Keep the antennas away from the electronic devices to prevent unwanted interference.

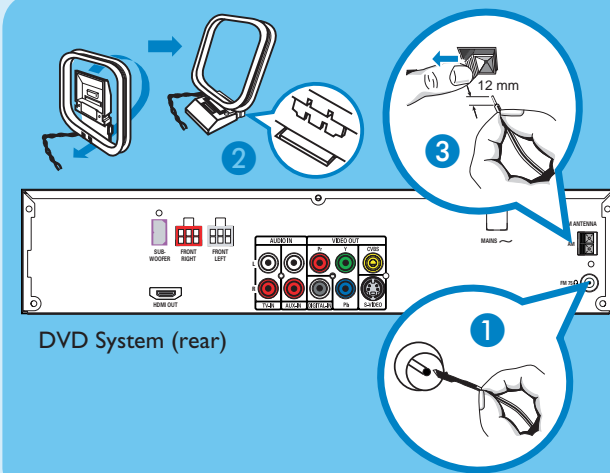

- 1 Connect the FM antenna to the FM jack. Extend the wire and fix its end to the wall.
- 2 Unfold the AM/MW loop antenna and fix the claw into the slot.
- 3 Push the tabs and insert the wires into the AM/MW jacks.

## C Connect the SonoWave speakers and subwoofer

Connect the left speaker to the FRONT LEFT jack, right speaker to the FRONT RIGHT jack and the subwoofer to the SUBWOOFER jack at the rear of the DVD system.

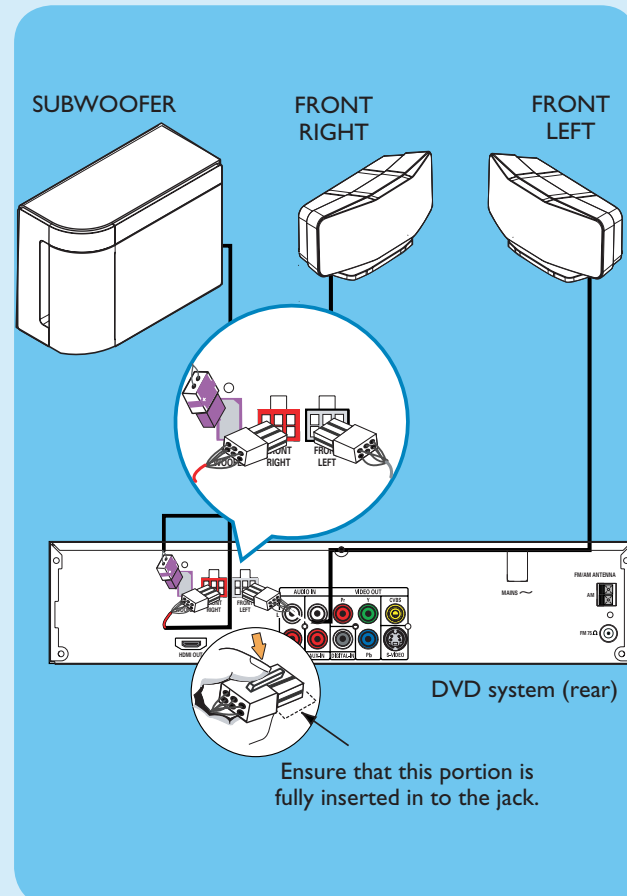

## D Connect the DVD system to TV

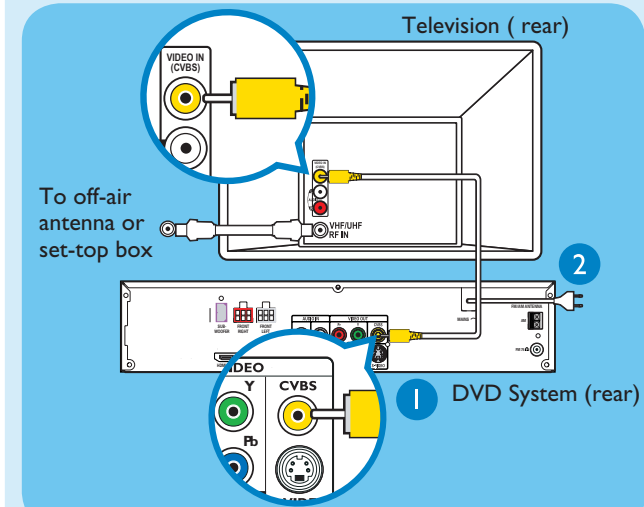

- 1 Use the supplied composite video cable to connect the CVBS jack on this DVD system to the VIDEO IN jack on your TV.
- 2 Plug in the power cables from the DVD system and TV to the AC power outlets.

**Note** It is important to connect the DVD system directly to your TV.

## E Connect the audio from TV to DVD system (optional)

To hear the TV audio through this home theater system, use the red and white audio cables (not supplied) to connect the TV IN (R/L) jacks on this DVD system to the AUDIO output jacks on your TV.

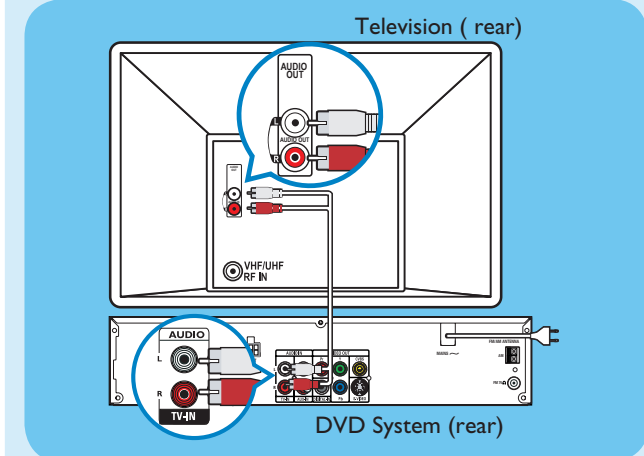

**Note** Press **TV** on the remote control to get the sound output from the speakers system when watching the TV program.

# 2 Set up

## A Finding the viewing channel

- 1 Press **STANDBY ON** on the DVD system.
- 2 Press **SOURCE** on the DVD system until "DISC" appears on the display panel.
- 3 Turn on the TV. Use the TV's remote control to select the correct viewing channel for the DVD system. You should see the blue DVD background on the TV.

**Note** To search for the correct viewing channel, press the Channel Down button on the TV's remote control repeatedly (or AV, SELECT, button) until you see the blue DVD background. If you are using a RF modulator, set the TV to channel 3 or 4.

## B Setting up the SonoWave speakers

- 1 Press and hold **SOUND** on the remote control to enter the SonoWave speaker settings mode.
- 2 Use keys to view the available settings (ROOM ACOUSTICS, SPEAKER DISTANCE, LISTENING POSITION) and press **OK** to select.
- 3 Use keys to select a most suitable predefined setting and press **OK** to confirm.

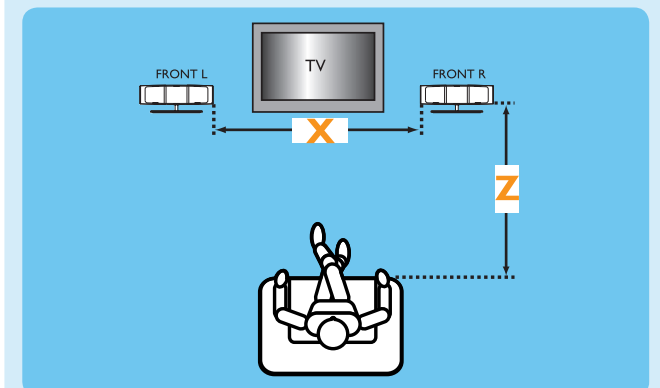

### ROOM ACOUSTICS

HARD - for concrete/glass walls.

SOFT - for wooden walls.

### SPEAKER DISTANCE

NEAR - 'X' is less than 1 meter.

DEFAULT - 'X' is between 1~2.5 meters.

FAR - 'X' is more than 2.5 meters.

### LISTENING POSITION

NEAR - 'Z' is less than 1.5 meter.

DEFAULT - 'Z' is between 1.5~2.5 meters.

FAR - 'Z' is more than 2.5 meters.

**Note** The underlined options are the default setting.

# 3 Enjoy

## Start disc playback

- 1 Insert a disc into the disc slot with the disc label facing up.

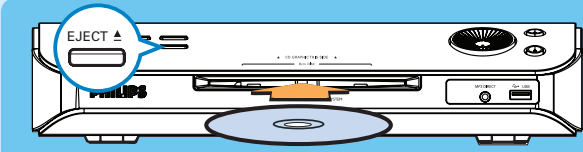

- 2 Playback will start automatically.
- 3 If the disc menu appears, use **▼▲** keys to select an option in the menu and press **PLAY ▶** to start playback.
- 4 To enjoy the powerful surround sound from the SonoWave speakers, press **SONOWAVE** (or **SURR** on the remote control) to turn on the multi-channel surround mode.
- 5 Press **STOP ■** to stop playback.

**Note** When you press PLAY button again, the playback will resume from where it last stopped. To start playback from the beginning, you have to press STOP button two times to cancel the resume mode, then press PLAY button.

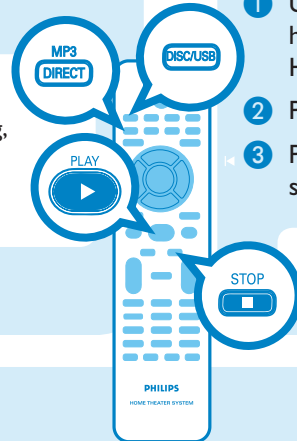

## Playback from the USB

- 1 Insert your USB device into the USB port and wait for the message to appear on the screen.
- 2 Press **DISC/USB** to access the contents on your USB device.
- 3 Press **OK** to start playback.
- 4 To stop playback, press **DISC/USB** again to switch to 'DISC' mode. You can unplug your USB device now.

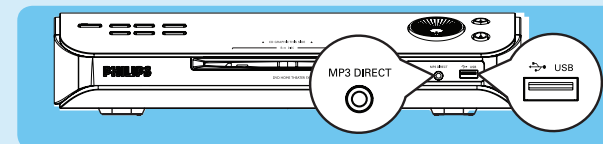

## Playback from the portable audio/HDD player

- 1 Use the supplied MP3 direct cable to connect the headphone output jack on your portable audio/HDD player to the MP3 DIRECT jack.
- 2 Press **MP3 DIRECT** on the remote control.
- 3 Press **PLAY** on your portable audio/HDD player to start playback.

**Note** You can only control the playback features using your portable audio/HDD player.

## Troubleshooting

For more troubleshooting tips, see the user manual.

### No picture.

- Press DISC/USB button on the remote control.
- Check the connection to the TV and ensure the plugs are firmly in place.

### No sound.

- Check the speaker connections and settings.
- Check the audio connections and press SOURCE button to select the correct input source.
- Press SONOWAVE button (or SURR. on the remote control) to turn on the multi-channel surround output.

### The DVD system does not work.

- Disconnect the power cord from the power outlet for a few minutes. Reconnect the power cord and try again.

## Need help?

### User Manual

See the user manual that comes with your Philips DVD System

### Online

Go to [www.philips.com/usasupport](http://www.philips.com/usasupport)

### Hotline

Call 1-888-PHILIPS (1-888-744-5477) for our operators.



2005 © Philips Consumer Electronics  
A Division of Philips Electronics North America Corp  
P.O. Box 671539  
Marietta, GA 30006-0026  
Printed in China  
12 NC 3139 245 21773

# Quick Start Guide



- 1 Connect
- 2 Set up
- 3 Enjoy

## What's in the box?

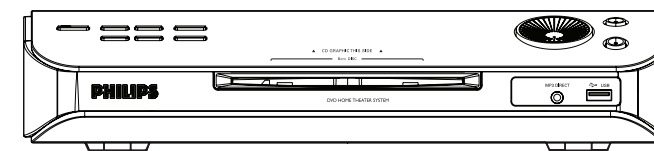

DVD system



Remote Control and 2 batteries

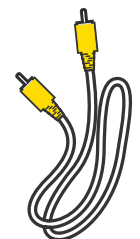

Composite video cable

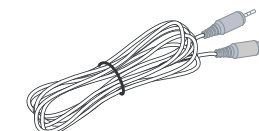

MP3 direct cable for portable audio player

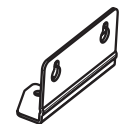

2 sets of wall mount brackets

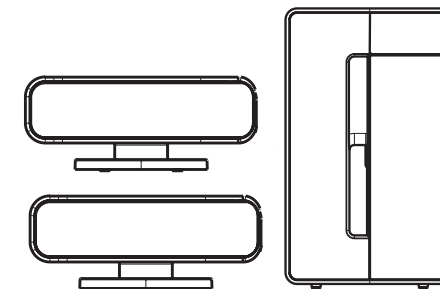

2 SonoWave speakers and subwoofer



FM wire antenna

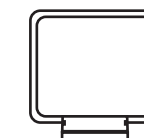

AM/MW loop antenna

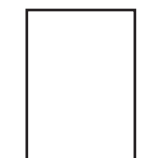

User Manual

# PHILIPS