

# Micro Hi-Fi System

MC235B

Register your product and get support at  
[www.philips.com/welcome](http://www.philips.com/welcome)



Thank you for choosing Philips.

## Need help fast?

Read your Quick Start Guide and/or User Manual first for quick tips that make using your Philips product more enjoyable.

If you have read your instructions and still need assistance, you may access our online help at

[www.philips.com/welcome](http://www.philips.com/welcome)  
or call

1-888-PHILIPS (744-5477)  
while with your product.  
(and Model / Serial number)



Philips vous remercie de votre confiance.

## Besoin d'une aide rapide?

Le Guide rapide de début et Manuel de l'utilisateur regorgent d'astuces destinées à simplifier l'utilisation de votre produit Philips. Toutefois, si vous ne parvenez pas à résoudre votre problème, vous pouvez accéder à notre aide en ligne à l'adresse

[www.philips.com/welcome](http://www.philips.com/welcome)  
ou formez le

1-800-661-6162 (Francophone)  
1-888-PHILIPS (744-5477) (English speaking)  
Veillez à avoir votre produit à portée de main.  
(et model / serial nombre)



Gracias por escoger Philips

## Necesita ayuda inmediata?

Lea primero la Guía rápida del comienzo o el Manual del usuario, en donde encontrará consejos que le ayudarán a disfrutar plenamente de su producto Philips. Si después de leerlo aún necesita ayuda, consulte nuestro servicio de asistencia en línea en

[www.philips.com/welcome](http://www.philips.com/welcome)  
o llame al teléfono

1-888-PHILIPS (744-5477)  
y tenga a mano el producto.  
(y número de model / serial)



# PHILIPS

**Note :** This equipment has been tested and found to comply with the limits for a Class B digital device, pursuant to part 15 of the FCC Rules. These limits are designed to provide reasonable protection against harmful interference in a residential installation. This equipment generates, uses, and can radiate radio frequency energy and, if not installed and used in accordance with the instruction manual, may cause harmful interference to radio communications. However, there is no guarantee that interference will not occur in a particular installation. If this equipment does cause harmful interference to radio or television reception, which can be determined by turning the equipment off and on, the user is encouraged to try to correct the interference by one or more of the following measures :

- Relocate the receiving antenna.
- Increase the separation between the equipment and receiver
- Connect the equipment into an outlet on a circuit different from that to which the receiver is connected.
- Consult the dealer or an experienced radio/TV technician for help.

**IMPORTANT !**

**modifications not authorized by the manufacturer may void users authority to operate this device.**

**Remarque :** Cet équipement a été testé et a été certifié conforme aux limites imposées pour un appareil numérique de Classe B, conformément à la partie 15 des règlements FCC. Ces limites sont définies aux fins d'assurer une protection raisonnable contre les interférences nuisibles dans une installation résidentielle. Cet équipement génère, utilise et émet des fréquences radio qui, en cas d'une mauvaise installation ou d'une utilisation non-conforme aux instructions de ce manuel d'utilisation peuvent causer des interférences nuisibles aux communications radio. Il n'y a toutefois aucune garantie que des interférences nuisibles ne se produiront pas dans une installation donnée. Si cet équipement cause des interférences nuisibles avec votre poste radio ou de télévision, ce que vous pouvez déterminer en éteignant et en rallumant votre équipement, il est conseillé à l'utilisateur d'essayer de pallier à ces interférences nuisibles en prenant l'une ou l'autre des mesures suivantes:

- Changez la position de l'antenne de réception.
- Augmentez la séparation entre l'équipement et le récepteur.
- Branchez l'équipement sur une source d'alimentation différente de celle sur laquelle le récepteur est branché.
- Consultez votre distributeur ou un technicien qualifié en la matière pour assistance.

**IMPORTANTE !**

**las modificaciones no autorizadas por el fabricante pueden anular la autoridad de los usuarios para utilizar este aparato.**

**Nota :** Este aparato ha sido probado y cumple con los límites correspondientes a un aparato digital de Clase B, según la parte 15 de las Normas FCC. Estos límites han sido diseñados para facilitar suficiente protección frente a interferencias perjudiciales en una instalación residencial. Este aparato genera, utiliza y puede emitir energía de frecuencias de radio y, si no se instala y utiliza según el manual de instrucciones, puede provocar interferencias perjudiciales en las comunicaciones de radio. Sin embargo, no existe garantía de que las interferencias no ocurrirán en una instalación particular. Si este aparato provoca interferencias perjudiciales en la recepción de radio o televisión, que se puede identificar encendiendo y apagando el aparato, recomendamos al usuario que intente solucionar las interferencias siguiendo una o más de las siguientes medidas:

- Cambie la posición de la antena receptora.
- Aumente la separación entre el aparato y el receptor.
- Conecte el aparato a una toma de un circuito diferente al que está conectado el receptor.
- Consulte con el distribuidor o un técnico de radio/TV con experiencia para que le ayuden.

**¡IMPORTANTE!**

**modificações não autorizadas pelo fabricante, podem causar danos na operação deste aparelho.**

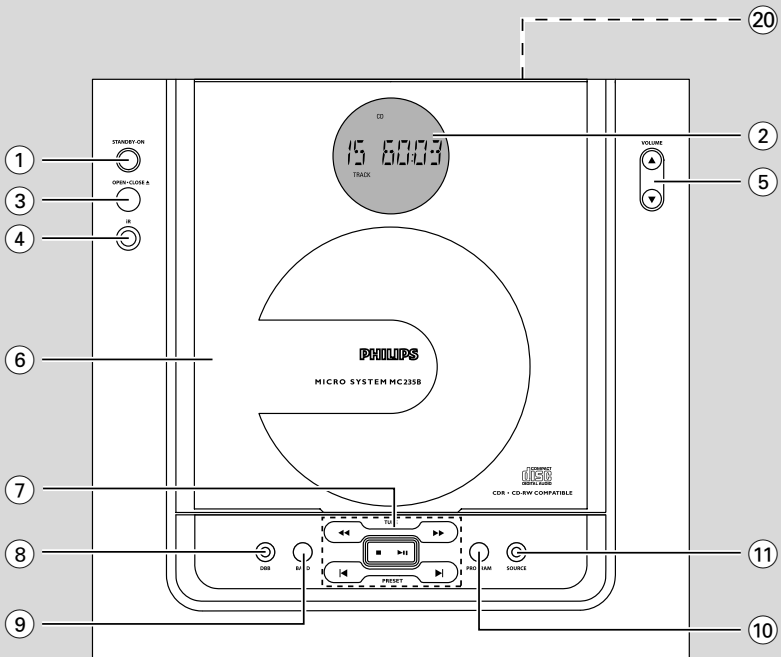
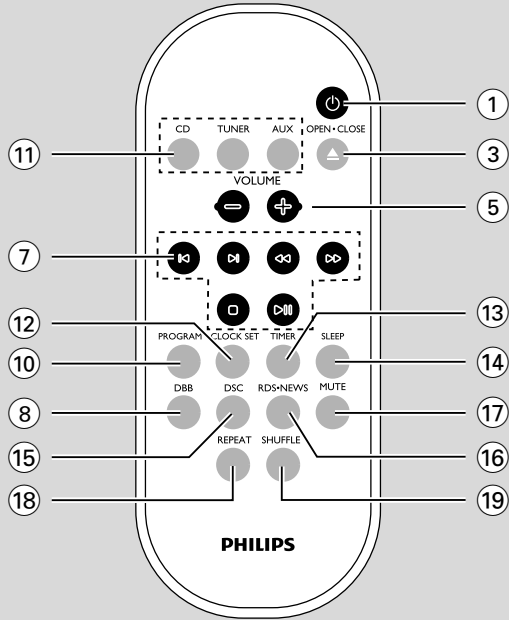

**Return your Product Registration Card or register online at  
www.philips.com/welcome today to get the very most from your purchase.**

Registering your model with PHILIPS makes you eligible for all of the valuable benefits listed below, so don't miss out. Complete and return your Product Registration Card at once, **or register online at www.philips.com/welcome** to ensure:

**\*Proof of Purchase**

Returning the enclosed card guarantees that your date of purchase will be on file, so no additional paperwork will be required from you to obtain warranty service.

**\*Product Safety Notification**

By registering your product, you'll receive notification - directly from the manufacturer - in the rare case of a product recall or safety defect.

**\*Additional Benefits**

Registering your product guarantees that you'll receive all of the privileges to which you're entitled, including special money-saving offers.

# PHILIPS

**Congratulations on your purchase, and welcome to the "family!"**

**Dear PHILIPS product owner:**

Thank you for your confidence in PHILIPS. You've selected one of the best-built, best-backed products available today. We'll do everything in our power to keep you happy with your purchase for many years to come. As a member of the PHILIPS "family," you're entitled to protection by one of the most comprehensive warranties and outstanding service networks in the industry. What's more, your purchase guarantees you'll receive all the information and special offers for which you qualify, plus easy access to accessories from our convenient home shopping network.

Most importantly, you can count on our uncompromising commitment to your total satisfaction.

All of this is our way of saying welcome - and thanks for investing in a PHILIPS product.

**P.S. To get the most from your PHILIPS purchase, be sure to complete and return your Product Registration Card at once, or register online at:**

**www.philips.com/welcome**

Know these **safety** symbols



This "bolt of lightning" indicates uninsulated material within your unit may cause an electrical shock. For the safety of everyone in your household, please do not remove product covering.

The "exclamation point" calls attention to features for which you should read the enclosed literature closely to prevent operating and maintenance problems.

**WARNING:** To reduce the risk of fire or electric shock, this apparatus should not be exposed to rain or moisture and objects filled with liquids, such as vases, should not be placed on this apparatus.

**CAUTION:** To prevent electric shock, match wide blade of plug to wide slot, fully insert.

**ATTENTION:** Pour éviter les choc électriques, introduire la lame la plus large de la fiche dans la borne correspondante de la prise et pousser jusqu'au fond.

**For Customer Use**

Enter below the Serial No. which is located on the rear of the cabinet. Retain this information for future reference.

Model No. \_\_\_\_\_  
Serial No. \_\_\_\_\_

Visit our World Wide Web Site at <http://www.philips.com/welcome>

# IMPORTANT SAFETY INSTRUCTIONS

1. **Read these instructions.**
2. **Keep these instructions.**
3. **Heed all warnings.**
4. **Follow all instructions.**
5. **Do not use this apparatus near water.**
6. **Clean only with dry cloth.**
7. **Do not block any ventilation openings. Install in accordance with the manufacturer's instructions.**
8. **Do not install near any heat sources**

such as radiators, heat registers, stoves, or other apparatus (including amplifiers) that produce heat.

9. **Do not defeat the safety purpose** of the polarized or

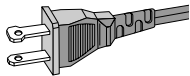

**AC Polarized Plug**

grounding-type plug. A polarized plug has two blades with one wider than the other. A grounding type plug has two blades and a third grounding prong. The wide blade or the third prong are provided for your safety. If the provided plug does not fit into your outlet, consult an electrician for replacement of the obsolete outlet.

10. **Protect the power cord** from being walked on or pinched, particularly at plugs, convenience receptacles, and the point where they exit from the apparatus.
11. **Only use attachments/accessories** specified by the manufacturer.
12.  **Use only with the cart**, stand, tripod, bracket, or table specified by the manufacturer or sold with the apparatus. When a cart is used, use caution when moving the cart /apparatus combination to avoid injury from tip-over.

13. **Unplug this apparatus** during lightning storms or when unused for long periods of time.
14. **Refer all servicing** to qualified service personnel. Servicing is required when the apparatus has been damaged in any way, such as power-supply cord or plug is damaged, liquid has been spilled or objects have fallen into the apparatus, the apparatus has been exposed to rain or moisture, does not operate normally, or has been dropped.

15. **Where the MAINS plug or an appliance coupler is used as the disconnet device, the disconnet device shall remain readily operable.**

16. **Battery usage CAUTION** – To prevent battery leakage which may result in bodily injury, property damage, or damage to the unit:

Install **all** batteries correctly, **+** and **-** as marked on the unit.

Do not mix batteries (**old** and **new** or **carbon** and **alkaline**, etc.).

Remove batteries when the unit is not used for a long time.

17. **Apparatus shall not be exposed to dripping or splashing.**
18. **Do not place any sources of danger on the apparatus** (e.g. liquid filled objects, lighted candles).
19. This product may contain lead and mercury. Disposal of these materials may be regulated due to environment considerations.

**For disposal or recycling information, please contact your local authorities or the Electronic Industries Alliance: [www.eiae.org](http://www.eiae.org).**

**EL 6475-S004: 03/12**

**Class II equipment symbol**



This symbol indicates that the unit has a double insulation system

# Index

English

English ..... 7

Français

Français ..... 20

Español

Español ..... 36

## Canada

### English:

This digital apparatus does not exceed the Class B limits for radio noise emissions from digital apparatus as set out in the Radio Interference Regulations of the Canadian Department of Communications.

### Français:

Cet appareil numérique n'émet pas de bruits radioélectriques dépassant les limites applicables aux appareils numériques de Class B prescrites dans le Règlement sur le Brouillage Radioélectrique édicté par le Ministère des Communications du Canada.

## CAUTION

*Use of controls or adjustments or performance of procedures other than herein may result in hazardous radiation exposure or other unsafe operation.*

## ATTENTION

*L'utilisation des commandes ou réglages ou le non-respect des procédures ci-incluses peuvent se traduire par une exposition dangereuse à l'irradiation.*

## ATENCIÓN

*El uso de mando o ajustes o la ejecución de métodos que no sean los aquí descritos puede ocasionar peligro de exposición a radiación.*

## General Information

Environmental information .....	8
Supplied accessories .....	8
Safety information .....	8

## Preparations

Rear connections .....	9–10
Optional connection .....	10
Before using the remote control .....	10
Replacing battery (lithium CR2025) into the remote control .....	10

## Controls

Controls on the system and remote control .....	11
---	----

## Basic Functions

Switching the system on .....	12
Adjusting volume and sound .....	12

## CD Operation

Playing a disc .....	13
Selecting a different track .....	13
Finding a passage within a track .....	13
Different play modes: Shuffle and Repeat .....	14
Programming track numbers .....	14
Reviewing the programme .....	14
Erasing the programme .....	14

## Radio Reception

Tuning to radio stations .....	15
Programming radio stations .....	15
Tuning to preset radio stations .....	15

## Clock/Timer

Setting the clock .....	16
Viewing the clock .....	16
Setting the timer .....	16
Activating and deactivating TIMER .....	16
Activating and deactivating SLEEP .....	16

<b>Specifications</b> .....	17
-----------------------------	----

<b>Maintenance</b> .....	17
--------------------------	----

<b>Troubleshooting</b> .....	18
------------------------------	----

## Hearing Safety

### Listen at a moderate volume.

- Using headphones at a high volume can impair your hearing. This product can produce sounds in decibel ranges that may cause hearing loss for a normal person, even for exposure less than a minute. The higher decibel ranges are offered for those that may have already experienced some hearing loss.
- Sound can be deceiving. Over time your hearing "comfort level" adapts to higher volumes of sound. So after prolonged listening, what sounds "normal" can actually be loud and harmful to your hearing. To guard against this, set your volume to a safe level before your hearing adapts and leave it there.

### To establish a safe volume level:

- Set your volume control at a low setting.
- Slowly increase the sound until you can hear it comfortably and clearly, without distortion.

### Listen for reasonable periods of time:

- Prolonged exposure to sound, even at normally "safe" levels, can also cause hearing loss.
- Be sure to use your equipment reasonably and take appropriate breaks.

### Be sure to observe the following guidelines when using your headphones.

- Listen at reasonable volumes for reasonable periods of time.
- Be careful not to adjust the volume as your hearing adapts.
- Do not turn up the volume so high that you can't hear what's around you.
- You should use caution or temporarily discontinue use in potentially hazardous situations.
- Do not use headphones while operating a motorized vehicle, cycling, skateboarding, etc.; it may create a traffic hazard and is illegal in many areas.

## General Information

Congratulations on your purchase, and welcome to Philips! To fully benefit from the support that Philips offers, register your product at [www.philips.com/welcome](http://www.philips.com/welcome).

**This system complies with the FCC rules, Part 15 and with 21 CFR 1040. 10.**

**Operation is subject to the following two conditions:**

- **This device may not cause harmful interference, and**
- **this device must accept any interference received, including interference that may cause undesired operation.**

### Environmental Information

All unnecessary packaging has been omitted. We have tried to make the packaging easy to separate into three materials: cardboard (box), polystyrene foam (buffer) and polyethylene (bags, protective foam sheet).

Your system consists of materials which can be recycled and reused if disassembled by a specialized company. Please observe the local regulations regarding the disposal of packaging materials, exhausted batteries and old equipment.

Your product is designed and manufactured with high quality materials and components, which can be recycled and reused.

Never dispose of your product with other household waste. Please inform yourself about the local rules on the separate collection of electrical and electronic products and batteries. The correct disposal of these products helps prevent potentially negative consequences on the environment and human health.

Your product contains batteries, which cannot be disposed of with normal household waste. Please inform yourself about the local rules on separate collection of batteries. The correct disposal of batteries helps prevent potentially negative consequences on the environment and human health.

Please visit [www.recycle.philips.com](http://www.recycle.philips.com) for additional information on a recycling center in your area.

Perchlorate Material - special handling may apply. See [www.dtsc.ca.gov/hazardouswaste/perchlorate](http://www.dtsc.ca.gov/hazardouswaste/perchlorate).

### Supplied accessories

- 2 speaker boxes
- remote control (with battery)
- AM loop antenna
- FM wire antenna
- stand
- screw and plug assembly

### Safety Information

- Before operating the system, check that the operating voltage indicated on the typeplate (or the voltage indication beside the voltage selector) of your system is identical with the voltage of your local power supply. If not, please consult your dealer.
- Where the MAINS plug or an appliance coupler is used as the disconnect device, the disconnect device shall remain readily operable.
- Place the system on a flat, hard and stable surface.
- Place the system in a location with adequate ventilation to prevent internal heat build-up in your system. Allow at least 10 cm (4 inches) clearance from the rear and the top of the unit and 5 cm (2 inches) from each side.
- The ventilation should not be impeded by covering the ventilation openings with items, such as newspapers, table-cloths, curtains, etc.
- Do not expose the system, batteries or discs to excessive moisture, rain, sand or heat sources caused by heating equipment or direct sunlight.
- No naked flame sources, such as lighted candles, should be placed on the apparatus.
- No objects filled with liquids, such as vases, shall be placed on the apparatus.
- If the system is brought directly from a cold to a warm location, or is placed in a very damp room, moisture may condense on the lens of the disc unit inside the system. Should this occur, the CD player would not operate normally. Leave the power on for about one hour with no disc in the system until normal playback is possible.
- The mechanical parts of the set contain self-lubricating bearings and must not be oiled or lubricated.
- **When the system is switched to Standby mode, it is still consuming some power. To disconnect the system from the power supply completely, remove the AC power plug from the wall socket.**



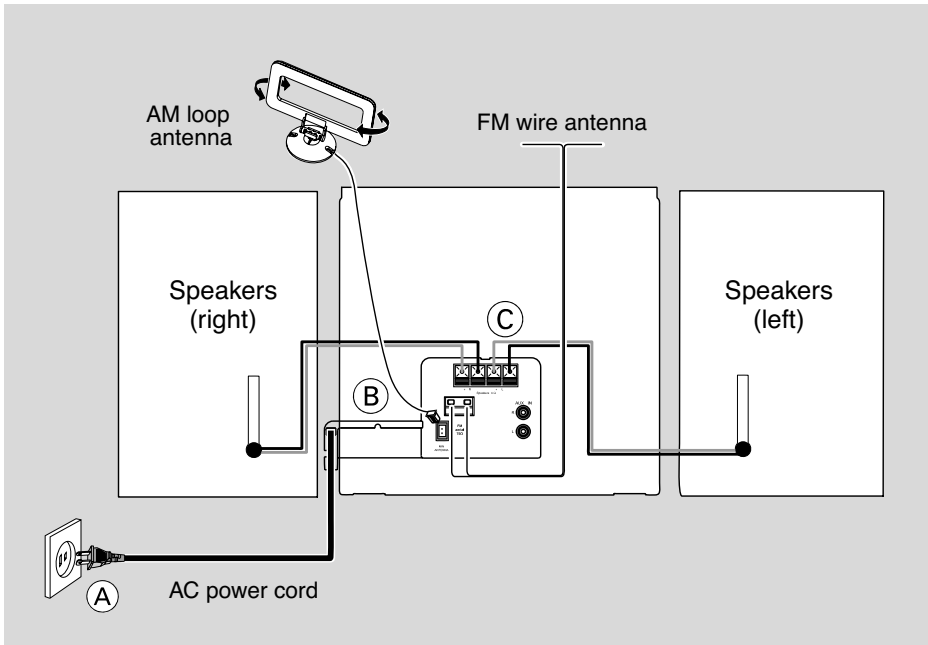

## Rear connections

*The type plate is located at the rear of the system.*

### (A) Power

Before connecting the AC power cord to the wall outlet, ensure that all other connections have been made.

#### **WARNING!**

- For optimal performance, use only the original power cable.
- Never make or change any connections with the power switched on.

*To avoid overheating of the system, a safety circuit has been built in. Therefore, your system may switch to Standby mode automatically under extreme conditions. If this happens, let the system cool down before reusing it (not available for all versions).*

### (B) Antennas Connection

Connect the supplied AM loop antenna and FM antenna to the respective terminals. Adjust the position of the antenna for optimal reception.

#### AM Antenna

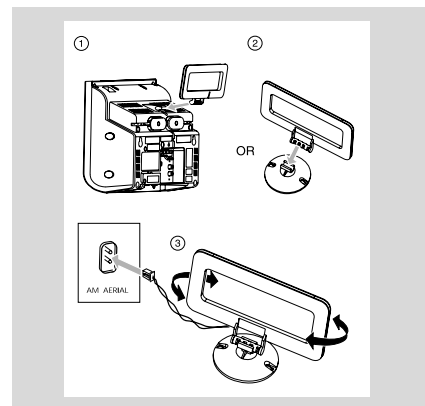

- Position the antenna as far as possible from a TV, VCR or other radiation source.

# Preparations

## FM Antenna

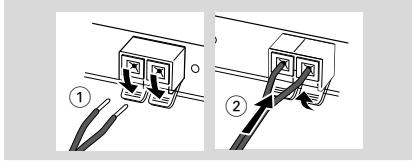

- For better FM stereo reception, connect an outdoor FM antenna to the FM AERIAL (FM ANTENNA) terminal.

## C Speakers Connection

### Front Speakers

Connect the speaker wires to the SPEAKERS terminals, right speaker to "RIGHT" and left speaker to "LEFT", coloured (marked) wire to "+" and black (unmarked) wire to "-".

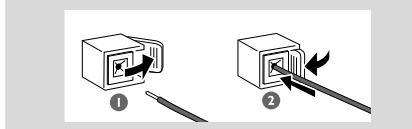

- Fully insert the stripped portion of the speaker wire into the terminal as shown.

### Notes:

- For optimal sound performance, use the supplied speakers.
- Do not connect more than one speaker to any one pair of + / - speaker terminals.
- Do not connect speakers with an impedance lower than the speakers supplied. Please refer to the SPECIFICATIONS section of this manual.

## Optional connection

The optional equipment and connecting cords are not supplied. Refer to the operating instructions of the connected equipment for details.

### Connecting other equipment to your system

Connect the audio left and right OUT terminals of a TV, VCR, Laser Disc player, DVD player or CD Recorder to the **AUX-IN** terminals.

### Note:

- If you are connecting equipment with a mono output (a single audio out terminal), connect it to the AUX IN left terminal. Alternatively, you can use a "single to double" cinch cable (the output sound still remain mono).

## Before using the remote control

- 1 Pull out the plastic protective sheet.
- 2 Select the source you wish to control by pressing one of the source select keys on the remote control (for example CD, TUNER).
- 3 Then select the desired function (for example **▶▶**, **◀◀**, **▶▶**).

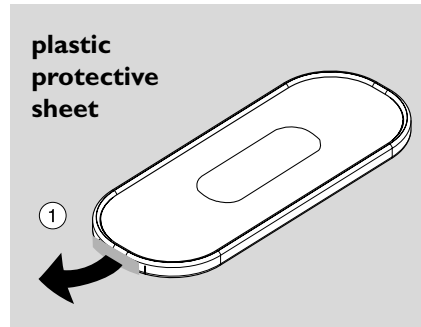

## Replacing battery (lithium CR2025) into the remote control

- 1 Pull out the knob (A) slightly to the left.
- 2 Pull out the battery compartment (B).
- 3 Replace a new battery and fully insert the battery compartment back to the original position.

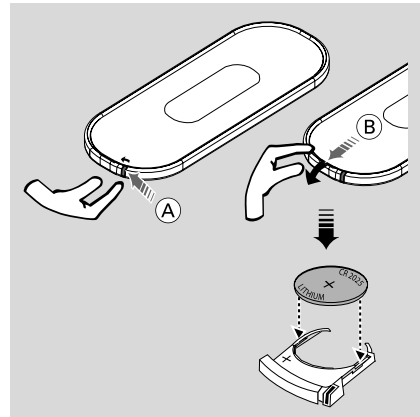

### CAUTION!

Batteries contain chemical substances, so they should be disposed off properly.

### NOTE:

Perchlorate Material - special handling may apply. See [www.dtsc.ca.gov/hazardouswaste/perchlorate](http://www.dtsc.ca.gov/hazardouswaste/perchlorate).

### Controls on the system and remote control

- ① **STANDBY-ON**
  - switches the system on or to standby.
- ② **Display**
  - shows the status of the system.
- ③ **OPEN • CLOSE ▲**
  - opens/ closes the CD door.
- ④ **IR**
  - remote sensor
- ⑤ **VOLUME (▲ / ▼) (+ / -)**
  - adjusts the volume level.
- ⑥ **CD Door**
- ⑦ **Mode Selection**
  - SEARCH/TUNE (◀ / ▶)**
    - for TUNER ..... tunes to a station
    - for CD ..... fast searches back and forward within a track/ CD.
  - STOP ■** ..... stops CD playback or erases a CD programme.
  - PLAY ▶▶** ..... starts or interrupts playback.
  - PRESET (◀ / ▶)**
    - for TUNER ..... selects a preset radio station.
    - for CD ..... skips to the beginning of a current track/ previous/ subsequent track
- ⑧ **DBB (Dynamic Bass Boost)**
  - enhances the bass.
- ⑨ **BAND**
  - selects a waveband.
- ⑩ **PROGRAM**
  - for CD ..... programmes tracks and reviews the programme.
  - for TUNER ..... programmes tuner stations.
- ⑪ **SOURCE**
  - selects the respective sound source for CD/ TUNER/ AUX.
- ⑫ **CLOCK SET**
  - sets the clock function.
  - views the clock.
- ⑬ **TIMER**
  - activates/deactivates or sets the timer function.
- ⑭ **SLEEP**
  - activates/deactivates or selects the sleeper time.
- ⑮ **DSC (Digital Sound Control)**
  - selects sound characteristics: ROCK/ JAZZ/ POP/ CLASSIC.

- ⑯ **RDS.NEWS**
  - activates RDS news and Traffic Announcement (not for all versions).
- ⑰ **MUTE**
  - interrupts and resumes sound reproduction.
- ⑱ **REPEAT**
  - repeats a track/ CD programme/ entire CD.
- ⑲ **SHUFFLE**
  - plays CD tracks in random order.
- ⑳ **🎧**
  - connects headphones

#### Notes for remote control:

- First select the source you wish to control by pressing one of the source select keys on the remote control (for example CD, TUNER).
- Then select the desired function (for example ▶▶, ◀, ▶).

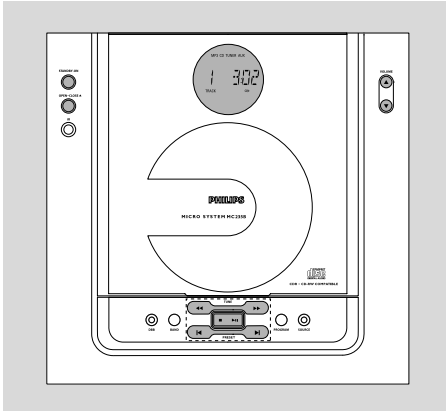

## Basic Functions



### **IMPORTANT!**

**Before you operate the system, complete the preparation procedures.**



### Switching the system on

- Press **STANDBY-ON** / .
  - The system will switch to the last selected source.
- Press **SOURCE** (or **CD**, **TUNER** or **AUX** on the remote control).
  - The system will switch to the selected source.
- Press **OPEN • CLOSE** .

### To switch the system to standby mode

- Press **STANDBY-ON** / .
  - The system enters the standby mode with clock display.
- The volume level (up to a maximum volume level of 20), interactive sound settings, source and tuner presets will be retained in the player's memory.

### Adjusting volume and sound

- 1 Press the **VOLUME**  /  (**+/-**) control to decrease or increase the volume.
    - Display shows the volume level  and a number from MIN1, 2, ...30, 31 MAX.
  - 2 Press **DSC** repeatedly to select the desired sound effect: **ROCK** / **JAZZ** / **POP** / **CLASSIC**.
  - 3 Press **DBB** to switch bass enhancement on or off.
    - Display shows: **DBB**.
  - 4 Press **MUTE** on the remote control to interrupt sound reproduction instantly.
    - Playback will continue without sound and the display shows **MUTE**.
- To activate sound reproduction you can:
    - press **MUTE** again;
    - adjust the volume controls;
    - change source.

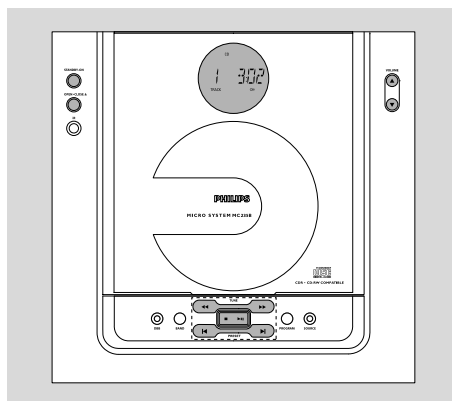

### IMPORTANT!

The lens of the CD player should never be touched.

### Playing a disc

This CD player plays Audio Discs including CD-Recordables and CD-Rewritables.

- CD-ROM, CD-I, CDV, VCD, MP3, DVD or computer CDs, however, are not possible.

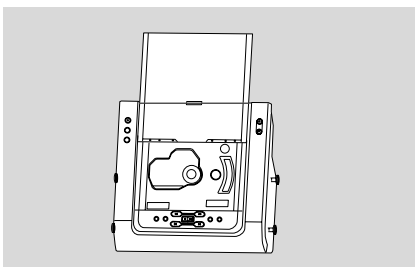

- 1 Press **SOURCE** to select CD.
- 2 Press **OPEN • CLOSE ▲** on the front panel of the system to open the CD compartment.  
→ **OPEN** is displayed when the compartment cover slides up.
- 3 Insert a disc with the printed side facing up. Press **OPEN • CLOSE ▲** again to close the compartment.  
→ **READING** is displayed as the CD player scans the contents of the disc.  
→ The total playing time and the total number of tracks are displayed.

- 4 Press **▶||** to start playback.  
→ Current track number and elapsed playing time of the track are displayed during disc playback.
- 5 To interrupt playback press **▶||**. Press **▶||** again to resume play.
- 6 To stop disc playback, press **STOP ■**.

*Note: CD play will also stop when;*

- the CD door is opened.
- the disc has reached the end.
- you select another source: **TUNER, AUX** or **standby**.

### Selecting a different track

- Press **◀|** or **|▶** once or repeatedly until the desired track number appears in the display.
- If you have selected a track number shortly after loading a disc or in the **PAUSE** position, you will need to press **▶||** to start playback.

### Finding a passage within a track

- 1 Press and hold **◀◀** or **▶▶**.  
→ The disc is played at high speed and low volume.
- 2 When you recognise the passage you want, release **◀◀** or **▶▶**.  
→ Normal playback continues.

# CD Operation

## Different play modes: SHUFFLE and REPEAT

You can select and change the various play modes before or during playback. The play modes can also be combined with PROGRAMME.

**SHUFFLE** .....tracks of the entire disc/ programme are played in random order

**SHUFFLE** and **REPEAT ALL**...to repeat the entire disc/ programme continuously in random order

**REPEAT ALL** ...repeats the entire disc/ programme

**REPEAT** .....plays the current track continuously

- 1 To select your play mode, press the **SHUFFLE** or **REPEAT** button before or during playback until the display shows the desired function.
  - 2 Press **▶||** to start playback if in the STOP position.  
→ If you have selected SHUFFLE, playback starts automatically.
  - 3 To return to normal playback, press the respective **SHUFFLE** or **REPEAT** button until the various SHUFFLE/ REPEAT modes are no longer displayed.
- You can also press **STOP ■** to cancel your play mode.

## Programming track numbers

Programme in the STOP position to select and store your disc tracks in the desired sequence. If you like, store any track more than once. Up to 40 tracks can be stored in the memory.

- 1 Press **PROGRAM** to enter the programming mode.  
→ A track number is shown and **PROGRAM** flashes.
- 2 Use the **◀** or **▶** to select your desired track number.
- 3 Press **PROGRAM** to confirm the track number to be stored.

→ The number of tracks programmed and the total playing time of the programme are show briefly, then the selected track and *PROG*.

- 4 Repeat steps 2-3 to select and store all desired tracks.  
→ *FULL* is displayed if you attempt to programme more than 40 tracks.
- 5 To start playback of your disc program, press **STOP ■** followed by **▶||** or press **▶||** directly.

## Reviewing the programme

In **STOP** mode, press and hold down **PROGRAM** for a while until the display shows all your stored track numbers in sequence.

## Erasing the programme

You can erase the programme by:

- pressing **STOP ■** once in the STOP mode;
- pressing **STOP ■** twice during playback;
- opening the CD compartment;  
→ **PROGRAM** disappears.  
→ *ERROR* scrolls and then disappears from the display.

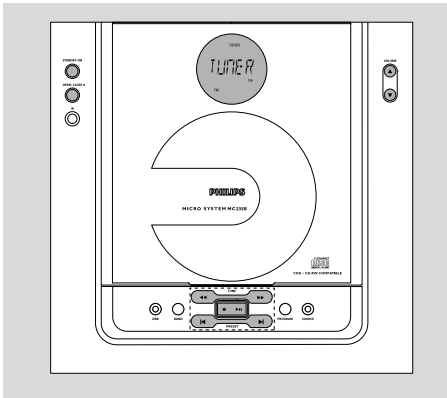

## Tuning to radio stations

- 1 Press **SOURCE** to select TUNER.  
→ TUNER is displayed briefly.
  - 2 Press **BAND** (or TUNER on the remote control) once or more to select your waveband. (FM/AM)
  - 3 Press and hold **TUNE** ◀◀ or ▶▶.  
→ The radio automatically tunes to a station with sufficient reception. Display indication during automatic tuning: SEARCH.
  - 4 Repeat step 3 if necessary until you find the desired station.
- To tune to a weak station, press **TUNE** ◀◀ or ▶▶ briefly and repeatedly until you have found optimal reception.

## Programming radio stations

You can store up to a total of 40 radio stations in the memory.

### Automatic programming

Automatic programming will start with a chosen preset number. From this preset number upwards, former programmed radio stations will be overridden. The system will only program stations which are not in the memory already.

- 1 Press **PRESET** ◀ or ▶ to select the preset number where programming should start.

#### Note:

- If no preset number is selected, default is preset (1) and all your presets will be overridden.

- 2 Press **PROGRAM** for more than 2 seconds to activate programming.  
→ AUTO is displayed and available stations are programmed in order of waveband reception strength: FM followed by AM. The last preset automatically stored will then be played.

### Manual programming

- 1 Tune to your desired station (see Tuning to radio stations).
  - 2 Press **PROGRAM** to activate programming.  
→ PROGRAM flashes in the display.
  - 3 Press **PRESET** ◀ or ▶ to allocate a number from 1 to 40 to this station.
  - 4 Press **PROGRAM** again to confirm the setting.  
→ PROGRAM disappears, the preset number and the frequency of the preset station are shown.
  - 5 Repeat the above four steps to store other stations.
- You can override a preset station by storing another frequency in its place.

### Tuning to preset radio stations

- Press **PRESET** ◀ or ▶ until the desired preset station is displayed.

# Clock/Timer

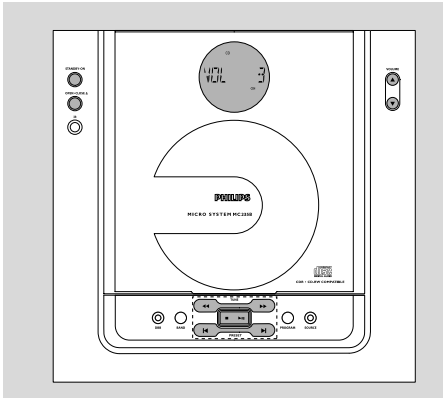

## Setting the clock

- 1 In standby mode or system on, press and hold **CLOCK SET** on the remote control for more than 3 seconds.  
→ *SET CLOCK* scrolls on the display.  
→ The clock digits for the hours flash.
- 2 Press **VOLUME +/-** to set the hours.
- 3 Press **CLOCK SET** again.  
→ The clock digits for the minutes flash.
- 4 Press **VOLUME +/-** to set the minutes.
- 5 Press **CLOCK SET** to confirm the time.

## Viewing the clock

Press **SET CLOCK**.  
→ The clock time is displayed.

## Setting the timer

- The system can be used as an alarm clock, whereby the CD, TUNER is switched on at a set time. The clock time needs to be set first before the timer can be used.
  - During setting, if no button is pressed within 90 seconds, the system will exit timer setting mode automatically.
- 1 In standby mode or system on, press and hold **TIMER** on the remote control for more than 3 seconds.  
→ *SET TIMER* and *SELECT SOURCE* scrolls on the display.
  - 2 Press **SOURCE** or **VOLUME +/-** to select sound source.

→ Display sequence shows *CD, TUNER*.  
→ flashes.

- 3 Press **TIMER** to confirm your desired mode.
- 4 Press **VOLUME +/-** to set the hours.
- 5 Press **TIMER** again.  
→ The clock digits for the minutes flash.
- 6 Press **VOLUME +/-** to set the minutes.
- 7 Press **TIMER** to confirm the time.  
→ The timer is now set and activated.

## Activating and deactivating TIMER

- Press **TIMER** on the remote to turn off the timer or turn on to the last setting again.  
→ If activated, the timer information will display for a few seconds, then the system resumes to the last active source or stays in standby mode.  
→ If deactivated, "OFF" appears.

### Note:

– The system will exit timer setting mode if no button is pressed within 90 seconds.

## Activating and deactivating SLEEP

The sleep timer enables the system to switch off by itself after a set period of time. The clock time needs to be set first before the sleep timer can be used.

- Press **SLEEP** on the remote control once or more.  
→ Display shows *SLEEP* and one of the sleep time options in sequence: *90, 75, 60, ..., 45, 30, 15, OFF, 90*. If you have selected a time. Once *SLEEP* is activated, *SLEEP* scrolls across the display at repeated intervals.
- To deactivate, press **SLEEP** on the remote control once or more until *OFF* is shown, or press **STANDBY-ON** on the system or remote control.

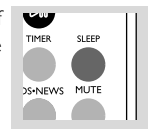



## AMPLIFIER

Output power ..... 20W total power  
 ..... 2 x 5 W RMS  
 ..... 2 x 4 W FTC<sup>(1)</sup>  
 Signal-to-noise ratio ..... ≥ 62 dBA (IEC)  
 Frequency response ..... 63 – 16000 Hz, ± 3 dB  
 Input sensitivity AUX ..... 0.5 V (max. 2 V)  
 Impedance loudspeakers ..... 4 Ω  
 Impedance headphones ..... 32 Ω -1000 Ω  
 (1) (4Ω, 60Hz - 12.5Hz, 10% THD)

## CD PLAYER

Frequency range ..... 30 – 16000 Hz  
 Signal-to-noise ratio ..... 75 dBA

## TUNER

FM wave range ..... 87.5 – 108 MHz  
 AM wave range ..... 530 – 1700 kHz  
 Sensitivity at 300 Ω  
 – mono, 26 dB signal-to-noise ratio ..... 2.8 μV  
 – stereo, 46 dB signal-to-noise ratio ..... 61.4 μV  
 Selectivity ..... ≥ 28 dB  
 Total harmonic distortion ..... ≤ 5%  
 Frequency response ..... 63 – 12500 Hz (± 3 dB)  
 Signal-to-noise-ratio ..... ≥ 50 dBA

## SPEAKERS

Bass reflex system  
 Dimensions (w x h x d) .... 166 x 245 x 90 (mm)

## GENERAL INFORMATION

AC Power ..... 110 - 220V / 60 Hz  
 Dimensions (w x h x d) .... 250 x 245 x 96 (mm)  
 Weight (with/without speakers) .....  
 ..... approx. 4.1 / 1.9 kg  
 Standby power consumption ..... < 2 W

### *Subject to modification*

# Maintenance

## Cleaning the Cabinet

- Use a soft cloth slightly moistened with a mild detergent solution. Do not use a solution containing alcohol, spirits, ammonia or abrasives.

## Cleaning Discs

- When a disc becomes dirty, clean it with a cleaning cloth. Wipe the disc from the center out.
- Do not use solvents such as benzene, thinner, commercially available cleaners, or antistatic spray intended for analog records.



## Cleaning the disc lens

- After prolonged use, dirt or dust may accumulate at the disc lens. To ensure good playback quality, clean the disc lens with Philips CD Lens Cleaner or any commercially available cleaner. Follow the instructions supplied with cleaner.

# Troubleshooting

## WARNING

*Under no circumstances should you try to repair the system yourself, as this will invalidate the warranty. Do not open the system as there is a risk of electric shock.*

*If a fault occurs, first check the points listed below before taking the system for repair. If you are unable to remedy a problem by following these hints, consult your dealer or Philips for help.*

## Problem

## Solution

### CD OPERATION

**"NO DISC" is displayed.**

- Insert a disc.
- Check if the disc is inserted upside down.
- Wait until the moisture condensation at the lens has cleared.
- Replace or clean the disc, see "Maintenance".
- Use a finalised CD-RW or CD-R.

### RADIO RECEPTION

**Radio reception is poor.**

- If the signal is too weak, adjust the antenna or connect an external antenna for better reception.
- Increase the distance between the Micro HiFi System and your TV or VCR.

### GENERAL

**The system does not react when buttons are pressed.**

- Remove and reconnect the AC power plug and switch on the system again.

**Sound cannot be heard or is of poor quality.**

- Adjust the volume.
- Disconnect the headphones.
- Check that the speakers are connected correctly.
- Check if the stripped speaker wire is clamped.

**The left and right sound outputs are reversed.**

- Check the speaker connections and location.

**The remote control does not function properly.**

- Select the source (CD or TUNER, for example) before pressing the function button (▶||, ◀, ▶).
- Reduce the distance between the remote control and the system.
- Insert the batteries with their polarities (+/- signs) aligned as indicated.
- Replace the batteries.
- Point the remote control directly toward IR sensor on the front of the system.

**The timer is not working.**

- Set the clock correctly.
- Press TIMER to switch on the timer.

**The Clock/Timer setting is erased.**

- Power has been interrupted or the power cord has been disconnected. Reset the clock/timer.

## PHILIPS LIMITED WARRANTY ONE (1) YEAR

### WARRANTY COVERAGE:

PHILIPS warranty obligation is limited to the terms set forth below.

### WHO IS COVERED:

Philips warrants the product to the original purchaser or the person receiving the product as a gift against defects in materials and workmanship as based on the date of original purchase ("Warranty Period") from an Authorized Dealer. The original sales receipt showing the product name and the purchase date from an authorized retailer is considered such proof.

### WHAT IS COVERED:

The Philips warranty covers new products if a defect in material or workmanship occurs and a valid claim is received by Philips within the Warranty Period. At its option, Philips will either (1) repair the product at no charge, using new or refurbished replacement parts, or (2) exchange the product with a product that is new or which has been manufactured from new, or serviceable used parts and is at least functionally equivalent or most comparable to the original product in Philips current inventory, or (3) refund the original purchase price of the product. Philips warrants replacement products or parts provided under this warranty against defects in materials and workmanship from the date of the replacement or repair for ninety (90) days or for the remaining portion of the original product's warranty, whichever provides longer coverage for you. When a product or part is exchanged, any replacement item becomes your property and the replaced item becomes Philips' property. When a refund is given, your product becomes Philips' property.

**Note: Any product sold and identified as refurbished or renewed carries a ninety (90) day limited warranty.**

**Replacement product can only be sent if all warranty requirements are met. Failure to follow all requirements can result in delay.**

### WHAT IS NOT COVERED - EXCLUSIONS AND LIMITATIONS:

This Limited Warranty applies only to the new products manufactured by or for Philips that can be identified by the trademark, trade name, or logo affixed to it. This Limited Warranty does not apply to any non-Philips hardware product or any software, even if packaged or sold with the product. Non-Philips manufacturers, suppliers, or publishers may provide a separate warranty for their own products packaged with the bundled product.

Philips is not liable for any damage to or loss of any programs, data, or other information stored on any media contained within the product, or any non-Philips product or part not covered by this warranty. Recovery or reinstallation of programs, data or other information is not covered under this Limited Warranty.

This warranty does not apply (a) to damage caused by accident, abuse, misuse, neglect, misapplication, or non-Philips product, (b) to damage caused by service performed by anyone other than Philips or Philips Authorized Service Location, (c) to a product or a part that has been modified without the written permission of

Philips, or (d) if any Philips serial number has been removed or defaced, or (e) product, accessories or consumables sold "AS IS" without warranty of any kind by including refurbished Philips product sold "AS IS" by some retailers.

### This Limited Warranty does not cover:

- Shipping charges to return defective product to Philips.
- Labor charges for installation or setup of the product, adjustment of customer controls on the product, and installation or repair of antenna/signal source systems outside of the product.
- Product repair and/or part replacement because of improper installation or maintenance, connections to improper voltage supply, power line surge, lightning damage, retained images or screen markings resulting from viewing fixed stationary content for extended periods, product cosmetic appearance items due to normal wear and tear, unauthorized repair or other cause not within the control of Philips.
- Damage or claims for products not being available for use, or for lost data or lost software.
- Damage from mishandled shipments or transit accidents when returning product to Philips.
- A product that requires modification or adaptation to enable it to operate in any country other than the country for which it was designed, manufactured, approved and/or authorized, or repair of products damaged by these modifications.
- A product used for commercial or institutional purposes (including but not limited to rental purposes).
- Product lost in shipment and no signature verification receipt can be provided.
- Failure to operate per Owner's Manual.

### TO OBTAIN ASSISTANCE IN THE U.S.A., PUERTO RICO, OR U.S. VIRGIN ISLANDS...

Contact Philips Customer Care Center at:  
1-888-PHILIPS (1-888-744-5477)

### TO OBTAIN ASSISTANCE IN CANADA...

1-800-661-6162 (French Speaking)  
1-888-PHILIPS (1-888-744-5477) - (English or Spanish Speaking)

REPAIR OR REPLACEMENT AS PROVIDED UNDER THIS WARRANTY IS THE EXCLUSIVE REMEDY FOR THE CONSUMER. PHILIPS SHALL NOT BE LIABLE FOR ANY INCIDENTAL OR CONSEQUENTIAL DAMAGES FOR BREACH OF ANY EXPRESS OR IMPLIED WARRANTY ON THIS PRODUCT. EXCEPT TO THE EXTENT PROHIBITED BY APPLICABLE LAW, ANY IMPLIED WARRANTY OF MERCHANTABILITY OR FITNESS FOR A PARTICULAR PURPOSE ON THIS PRODUCT IS LIMITED IN DURATION TO THE DURATION OF THIS WARRANTY.

Some states do not allow the exclusions or limitation of incidental or consequential damages, or allow limitations on how long an implied warranty lasts, so the above limitations or exclusions may not apply to you.

*This warranty gives you specific legal rights. You may have other rights which vary from state/province to state/province.*

Philips, P.O. Box 10313 Stamford, CT 06904

3140 035 50201

English

Français

Español

Philips Consumer Lifestyle  
A division of Philips Electronics North America Corporation  
P.O. Box 10313  
Stamford, CT 06904  
Phone: 1-888-PHILIPS (744-5477)  
Meet Philips at the Internet  
<http://www.philips.com/welcome>

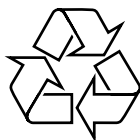

MC235B



Printed In China

MC235B\_37\_UM\_V2.0