



Thank you for choosing Philips.

Need help fast?

Read your Quick Use Guide and/or Owner's Manual first for quick tips that make using your Philips product more enjoyable.

If you have read your instructions and still need assistance, you may access our online help at

www.philips.com/usasupport
or call

1-888-PHILIPS (744-5477)
while with your product.
(and Model / Serial number)



Philips vous remercie de votre confiance.

Besoin d'une aide rapide?

Les Guide d'utilisation rapide et Manuel de l'utilisateur regorgent d'astuces destinées à simplifier l'utilisation de votre produit Philips. Toutefois, si vous ne parvenez pas à résoudre votre problème, vous pouvez accéder à notre aide en ligne à l'adresse

www.philips.com/usasupport
ou formez le

1-800-661-6162 (Francophone)
1-888-PHILIPS (744-5477) (English speaking)
Veuillez à avoir votre produit à portée de main.
(et model / serial nombre)



Gracias por escoger Philips

Necesita ayuda inmediata?

Lea primero la Guía de uso rápido o el Manual del usuario, en donde encontrará consejos que le ayudarán a disfrutar plenamente de su producto Philips.

Si después de leerlo aún necesita ayuda, consulte nuestro servicio de asistencia en línea en

www.philips.com/usasupport
o llame al teléfono

1-888-PHILIPS (744-5477)
y tenga a mano el producto.
(y número de model / serial)



PHILIPS

Canada

English:

This digital apparatus does not exceed the Class B limits for radio noise emissions from digital apparatus as set out in the Radio Interference Regulations of the Canadian Department of Communications.

Français:

Cet appareil numérique n'émet pas de bruits radioélectriques dépassant les limites applicables aux appareils numériques de Class B prescrites dans le Règlement sur le Brouillage Radioélectrique édicté par le Ministère des Communications du Canada.

CAUTION

Use of controls or adjustments or performance of procedures other than herein may result in hazardous radiation exposure or other unsafe operation.

ATTENTION

L'utilisation des commandes ou réglages ou le non-respect des procédures ci-incluses peuvent se traduire par une exposition dangereuse à l'irradiation.

ATENCIÓN

El uso de mando o ajustes o la ejecución de métodos que no sean los aquí descritos puede ocasionar peligro de exposición a radiación.

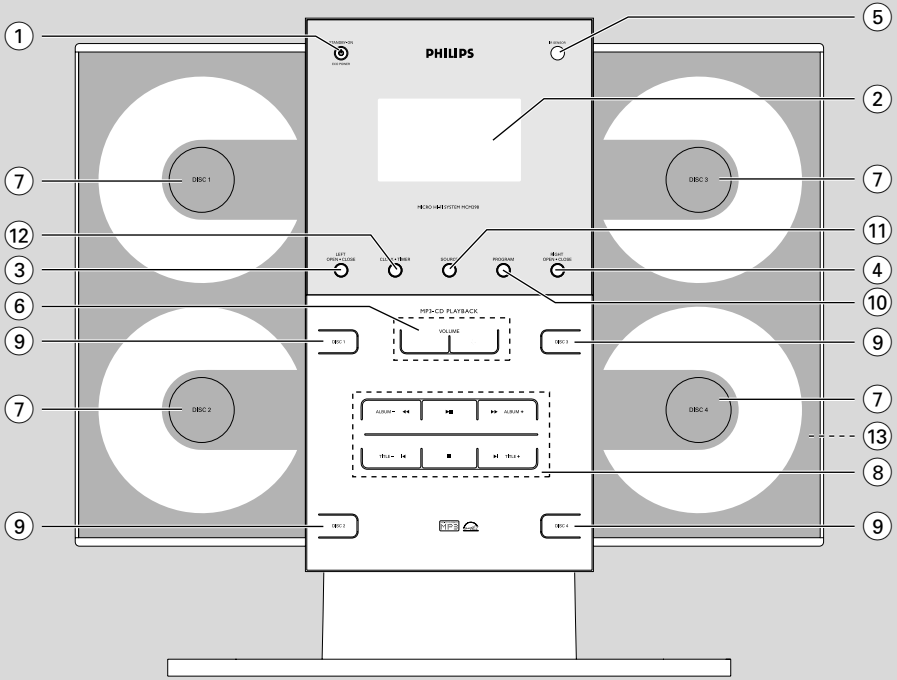

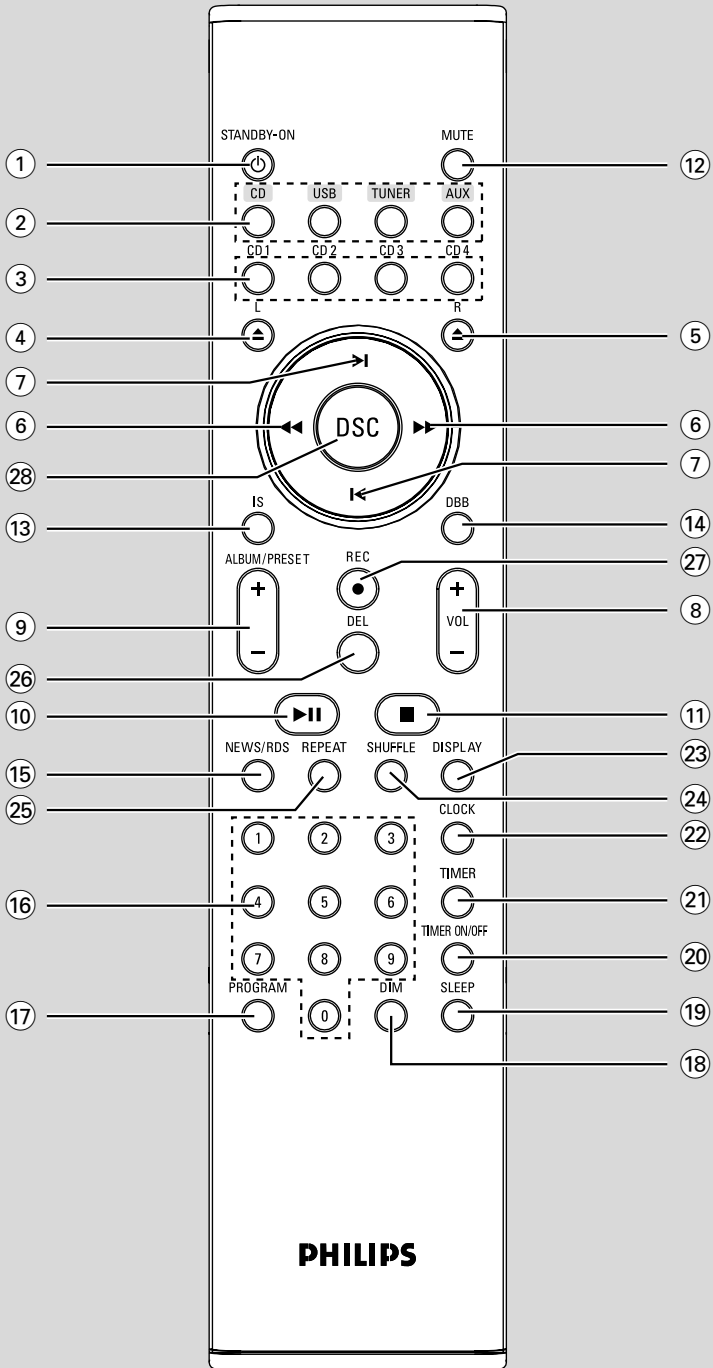

**Return your Product Registration Card or register online at
www.philips.com/usasupport today to get the very most from your purchase.**

Registering your model with PHILIPS makes you eligible for all of the valuable benefits listed below, so don't miss out. Complete and return your Product Registration Card at once, or register online at www.philips.com/usasupport to ensure:

***Proof of Purchase**

Returning the enclosed card guarantees that your date of purchase will be on file, so no additional paperwork will be required from you to obtain warranty service.

***Product Safety Notification**

By registering your product, you'll receive notification - directly from the manufacturer - in the rare case of a product recall or safety defect.

***Additional Benefits**

Registering your product guarantees that you'll receive all of the privileges to which you're entitled, including special money-saving offers.

PHILIPS

Congratulations on your purchase, and welcome to the "family!"

Dear PHILIPS product owner:

Thank you for your confidence in PHILIPS. You've selected one of the best-built, best-backed products available today. We'll do everything in our power to keep you happy with your purchase for many years to come.

As a member of the PHILIPS "family," you're entitled to protection by one of the most comprehensive warranties and outstanding service networks in the industry. What's more, your purchase guarantees you'll receive all the information and special offers for which you qualify, plus easy access to accessories from our convenient home shopping network.

Most importantly, you can count on our uncompromising commitment to your total satisfaction.

All of this is our way of saying welcome - and thanks for investing in a PHILIPS product.

P.S. To get the most from your PHILIPS purchase, be sure to complete and return your Product Registration Card at once, or register online at:

www.philips.com/usasupport

Know these **safety** symbols



⚡ This "bolt of lightning" indicates uninsulated material within your unit may cause an electrical shock. For the safety of everyone in your household, please do not remove product covering.

⚠ The "exclamation point" calls attention to features for which you should read the enclosed literature closely to prevent operating and maintenance problems.

WARNING: To reduce the risk of fire or electric shock, this apparatus should not be exposed to rain or moisture and objects filled with liquids, such as vases, should not be placed on this apparatus.

CAUTION: To prevent electric shock, match wide blade of plug to wide slot, fully insert.

ATTENTION: Pour éviter les choc électriques, introduire la lame la plus large de la fiche dans la borne correspondante de la prise et pousser jusqu'au fond.

For Customer Use

Enter below the Serial No. which is located on the rear of the cabinet. Retain this information for future reference.

Model No. _____
Serial No. _____

PHILIPS

Visit our World Wide Web Site at <http://www.philips.com/usasupport>

IMPORTANT SAFETY INSTRUCTIONS

1. **Read these instructions.**
2. **Keep these instructions.**
3. **Heed all warnings.**
4. **Follow all instructions.**
5. **Do not use this apparatus near water.**
6. **Clean only with dry cloth.**
7. **Do not block any ventilation openings. Install in accordance with the manufacturer's instructions.**
8. **Do not install near any heat sources** such as radiators, heat registers, stoves, or other apparatus (including amplifiers) that produce heat.

9. **Do not defeat the safety**

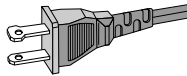

AC Polarized Plug

purpose of the polarized or

grounding-type plug. A polarized plug has two blades with one wider than the other. A grounding type plug has two blades and a third grounding prong. The wide blade or the third prong are provided for your safety. If the provided plug does not fit into your outlet, consult an electrician for replacement of the obsolete outlet.

10. **Protect the power cord** from being walked on or pinched, particularly at plugs, convenience receptacles, and the point where they exit from the apparatus.
11. **Only use attachments/accessories** specified by the manufacturer.

12.  **Use only with the cart,** stand, tripod, bracket, or table specified by the manufacturer or sold with the apparatus. When a cart is used, use caution when moving the cart /apparatus combination to avoid injury from tip-over.

13. **Unplug this apparatus** during lightning storms or when unused for long periods of time.
14. **Refer all servicing** to qualified service personnel. Servicing is required when the apparatus has been damaged in any way, such as power-supply cord or plug is damaged, liquid has been spilled or objects have fallen into the apparatus, the apparatus has been exposed to rain or moisture, does not operate normally, or has been dropped.

15. **Battery usage CAUTION** – To prevent battery leakage which may result in bodily injury, property damage, or damage to the unit:

Install **all** batteries correctly, **+** and **-** as marked on the unit.

Do not mix batteries (**old** and **new** or **carbon** and **alkaline**, etc.).

Remove batteries when the unit is not used for a long time.

16. **Apparatus shall not be exposed to dripping or splashing.**
17. **Do not place any sources of danger on the apparatus** (e.g. liquid filled objects, lighted candles).
18. This product may contain lead and mercury. Disposal of these materials may be regulated due to environment considerations. **For disposal or recycling information, please contact your local authorities or the Electronic Industries Alliance: www.eiae.org.**

EL 6475-S004: 03/12

Class II equipment symbol 
This symbol indicates that the unit has a double insulation system

English 8

Français 30

Español 53

English

Français

Español

Contents

General Information

Environmental information	9
Supplied accessories	9
Safety information	9

Preparations

Rear connections	10 – 11
Placing the set and speakers	11
Optional connection	11
Connecting other equipment to your system	
Inserting batteries into the Remote Control ...	
.....	12
Using the Remote Control to operate the Player	

Controls

Controls on the system	13
Controls on the remote	13~14

Basic Functions

Switching the system on	15
Switching the system to Eco Power Standby mode	15
Power Saving Automatic Standby	15
Adjusting volume and sound	15
Dimming the display screen	15

CD/MP3-CD Operation

Discs for playback	16
About MP3 disc	16
Loading a disc	16
Basic playback controls	17~18
Different play modes: SHUFFLE and REPEAT ...	
.....	18
Programming track numbers	18
Erasing the programme	18

Radio Reception

Tuning to radio stations	19
Programming radio stations	19~20
Automatic programming	
Manual programming	
Tuning to preset radio stations	20

Clock/Timer

Clock setting	21
Timer setting	21~22
Sleep timer setting	22

Specifications

Maintenance

Troubleshooting

Appendix

Environmental Information

All unnecessary packaging has been omitted. We have tried to make the packaging easy to separate into three materials: cardboard (box), polystyrene foam (buffer) and polyethylene (bags, protective foam sheet).

Your system consists of materials which can be recycled and reused if disassembled by a specialized company. Please observe the local regulations regarding the disposal of packaging materials, exhausted batteries and old equipment.

Supplied accessories

- 2 speaker boxes
- remote control (with battery)
- AM loop antenna
- FM wire antenna
- stands for the main set and speakers
- wall mounting kit

Safety Information

- Before operating the system, check that the operating voltage indicated on the typeplate (or the voltage indication beside the voltage selector) of your system is identical with the voltage of your local power supply. If not, please consult your dealer.
- Place the system on a flat, hard and stable surface.
- Place the system in a location with adequate ventilation to prevent internal heat build-up in your system. Allow at least 10 cm (4 inches) clearance from the rear and the top of the unit and 5 cm (2 inches) from each side.
- The ventilation should not be impeded by covering the ventilation openings with items, such as newspapers, table-cloths, curtains, etc.
- Do not expose the system, batteries or discs to excessive moisture, rain, sand or heat sources caused by heating equipment or direct sunlight.
- No naked flame sources, such as lighted candles, should be placed on the apparatus.
- No objects filled with liquids, such as vases, shall be placed on the apparatus.
- Install this unit near the AC outlet and where the AC power can be reached easily.
- If the system is brought directly from a cold to a warm location, or is placed in a very damp room, moisture may condense on the lens of the disc unit inside the system. Should this occur, the CD player would not operate normally. Leave the power on for about one hour with no disc in the system until normal playback is possible.
- The mechanical parts of the set contain self-lubricating bearings and must not be oiled or lubricated.
- **When the system is switched to Standby mode, it is still consuming some power. To disconnect the system from the power supply completely, remove the AC power plug from the wall socket.**

Preparations

English

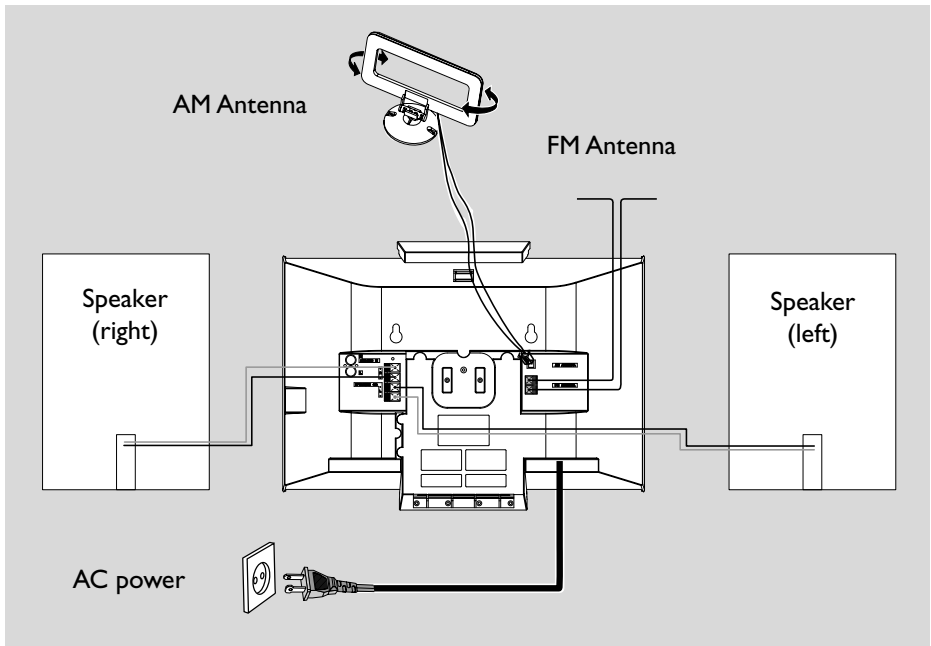

Rear connections

The type plate is located at the rear of the system.

A Power

Before connecting the AC power cord to the wall outlet, ensure that all other connections have been made.

Warning!

- For optimal performance, use only the original power cable.
- Never make or change any connections with the power switched on.

To avoid overheating of the system, a safety circuit has been built in. Therefore, your system may switch to Standby mode automatically under extreme conditions. If this happens, let the system cool down before reusing it (not available for all versions).

B Antennas Connection

Connect the supplied AM loop antenna and FM antenna to the respective terminals. Adjust the position of the antenna for optimal reception.

AM Antenna

- Position the antenna as far as possible from a TV, VCR or other radiation source.

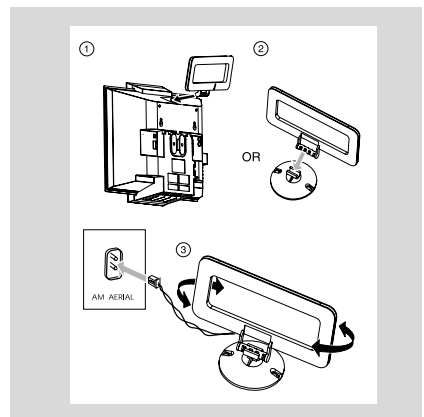

FM Antenna

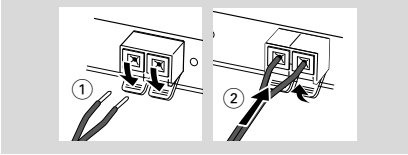

- For better FM stereo reception, connect an outdoor FM antenna to the FM ANTENNA terminal.

C Speakers Connection

Front Speakers

Connect the speaker wires to the SPEAKERS terminals, right speaker to "RIGHT" and left speaker to "LEFT", colored (marked) wire to "+" and black (unmarked) wire to "-".

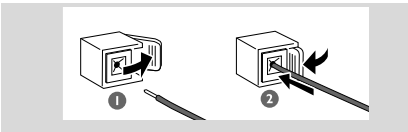

- Fully insert the stripped portion of the speaker wire into the terminal as shown.

Notes:

- For optimal sound performance, use the supplied speakers.
- Do not connect more than one speaker to any one pair of +/- speaker terminals.
- Do not connect speakers with an impedance lower than the speakers supplied. Please refer to the SPECIFICATIONS section of this manual.

Placing the set and speakers

With the supplied detachable stands and wall mounting kit, you can either place the main set and speakers on desktop or mount them onto wall. Desktop installation is taken for example here. For how to mount the system onto wall, please refer to **Appendix** and the attached **Wall Mounting Instructions**.

- 1 Align the side marked **PRESS▼** of the larger-size stand with the slots at the bottom of the main set.

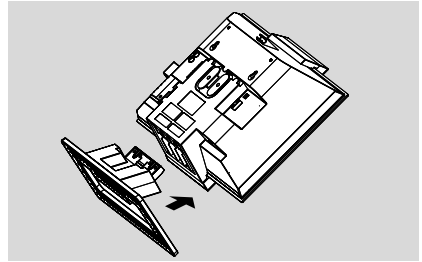

- 2 Push the stand down into the slots until you hear a click.
- 3 Attach the two smaller-size stands to the speakers in the same way.
- 4 Place the main set and speakers upright on the desktop with the support of the stands.

Note:

- To remove the stand from the main set or either speaker, while pressing down **PRESS▼**, pull the stand out from the slots.

Optional connection

The optional equipment and connecting cords are not supplied. Refer to the operating instructions of the connected equipment for details.

Connecting other equipment to your system

Connect the audio left and right OUT terminals of a TV, VCR, Laser Disc player, DVD player or CD Recorder to the **AUX/CDR IN** terminals.

Note:

- If you are connecting equipment with a mono output (a single audio out terminal), connect it to the AUX left terminal. Alternatively, you can use a "single to double" cinch cable (the output sound still remain mono).

Preparations

Inserting batteries into the Remote Control

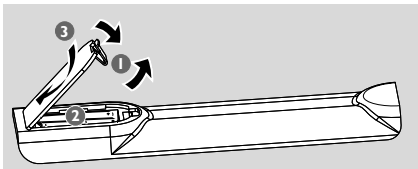

- 1 Open the battery compartment.
- 2 Insert two AAA batteries following the indications (+/-) inside the compartment.
- 3 Close the cover.







Using the Remote Control to operate the Player

- 1 Aim the Remote Control directly at the remote sensor (IR) on the front panel.
- 2 Do not put any objects between the Remote Control and the system while operating the system.

CAUTION!

- **Remove batteries if they are exhausted or if the Remote Control is not being used for a long time.**
- **Do not use old and new or different types of batteries in combination.**
- **Batteries contain chemical substances, so they should be disposed of properly.**

Controls on the system (illustrations on page 3)

- ① **STANDBY-ON/ ECO POWER** 
 - switches the system on or to Eco Power standby/normal standby with clock display.
- ② **Display screen**
 - shows the status of the system.
- ③ **LEFT OPEN • CLOSE**
 - opens/closes the left CD door.
- ④ **RIGHT OPEN • CLOSE**
 - opens/closes the right CD door.
- ⑤ **IR**
 - remote sensor
- ⑥ **VOLUME** $- / +$
 - adjusts the volume level.
- ⑦ **Disc trays**
- ⑧ **Mode Selection**
 - ALBUM** $- / +$  
 - for TUNER tunes to a station.
 - for CD/MP3-CD fast searches back and forward within a track/disc (press and hold).
 - for MP3-CD skips to the beginning of a current/previous/subsequent album.
 - for Clock/Timer sets the hour.
 -  stops disc playback or erases a disc program.
 -  starts or interrupts playback.
 - TITLE** $- / +$  
 - for TUNER selects a preset radio station.
 - for CD/MP3 -CD skips to the beginning of a current/previous/subsequent track.
 - for Clock/Timer sets the minute.
- ⑨ **DISC 1/2/3/4**
 - selects a disc tray for playback.
- ⑩ **PROGRAM**
 - for CD/MP3-CD programmes tracks and reviews the program.
 - for TUNER programs tuner stations.
- ⑪ **SOURCE**
 - selects the respective sound source for CD/TUNER (FM/AM)/ AUX.

⑫ CLOCK • TIMER

- sets the clock or timer function.

⑬

- connects headphones

Controls on the remote (illustrations on page 4)

① STANDBY-ON

- switches the system on or to Eco Power standby/normal standby with clock display.

② Source selection (USB unavailable for this version)

- selects the respective sound source for CD/TUNER (FM/AM)/ AUX.

③ CD 1/2/3/4

- selects a disc tray for playback.

④ **L**

- opens/closes the left CD door.

⑤ **R**

- opens/closes the right CD door.

⑥

- for TUNER tunes to a station.
- for CD/MP3-CD fast searches back and forward within a track/disc (press and hold).
- for MP3-CD skips to the beginning of a current/previous/subsequent album.
- for Clock/Timer sets the hour.

⑦

- for CD/MP3 -CD skips to the beginning of a current/previous/subsequent track.

⑧ **VOL +/-**

- adjusts the volume level.

⑨ **ALBUM/PRESET +/-**

- for TUNER selects a preset radio station.
- for MP3-CD skips to the beginning of a current/previous/subsequent album.
- for Clock/Timer sets the minute.

Controls

- ⑩ **▶ II**
 - starts or interrupts playback.
- ⑪ **■**
 - stops disc playback or erases a disc program.
- ⑫ **MUTE**
 - interrupts and resumes sound reproduction.
- ⑬ **IS (Incredible Surround)**
 - activates or deactivates the surround sound effect.
- ⑭ **DBB (Dynamic Bass Boost)**
 - enhances the bass.
- ⑮ **NEWS/RDS (unavailable for this version)**
- ⑯ **Numeric Keypad (0-9)**
 - for CD/MP3-CD selects a track for playback directly.
- ⑰ **PROGRAM**
 - for CD/MP3-CD programs tracks and reviews the program.
 - for TUNER programs tuner stations.
- ⑱ **DIM**
 - turns on or off the dim function for the display screen.
- ⑲ **SLEEP**
 - activates/deactivates or selects the sleeper time.
- ⑳ **TIMER ON/OFF**
 - activates/deactivates the timer function.
- ㉑ **TIMER**
 - sets the timer function.
- ㉒ **CLOCK**
 - sets the clock function.
- ㉓ **DISPLAY**
 - displays disc information during playback.
- ㉔ **SHUFFLE**
 - plays disc tracks in random order.
- ㉕ **REPEAT**
 - repeats a track/disc program/entire disc.
- ㉖ **DEL (unavailable for this version)**
- ㉗ **REC • (unavailable for this version)**
- ㉘ **DSC (Digital Sound Control)**
 - selects sound characteristics: ROCK/JAZZ/POP/CLASSIC.

Notes for remote control:

- First select the source you wish to control by pressing one of the source select keys on the remote control (for example CD, TUNER).
- Then select the desired function (for example ▶ II, ◀ ▶).

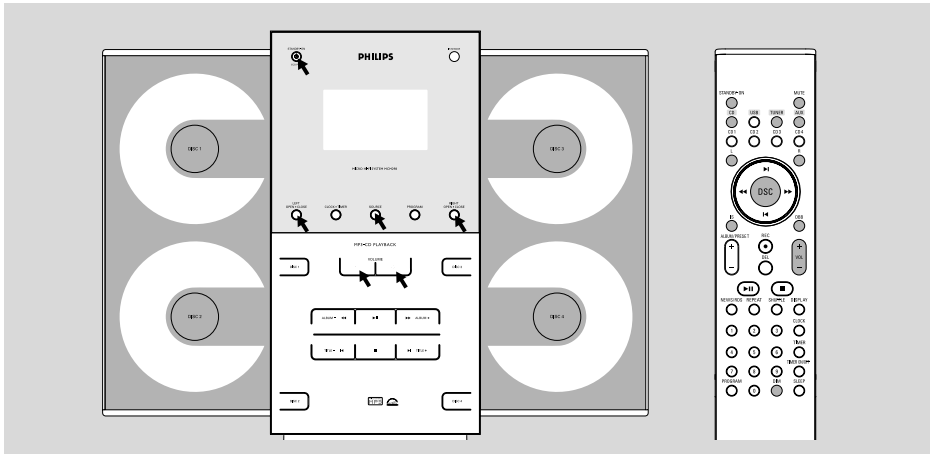

Important!

Before you operate the system, complete the preparation procedures.

Switching the system on

- Press **STANDBY-ON/ECO POWER** .
→ The system will switch to the last selected source.
- Press **SOURCE** on the front panel or **CD**, **TUNER** or **AUX** on the remote control.
→ The system will switch to the selected source.
- Press **LEFT OPEN • CLOSE** or **RIGHT OPEN • CLOSE** on the front panel (**L ▲** or **R ▲** on the remote).
→ The system will switch to the CD source.

Switching the system to Eco Power Standby mode

- Press **STANDBY-ON/ECO POWER** in the active mode.
→ The system enters Eco power standby (the ECO POWER LED is on) or normal standby with clock display.
- If the system is in normal standby with clock display, press and hold **STANDBY-ON/ECO POWER** for 3 seconds or more to switch to Eco power standby or vice versa.
- The volume level (up to a maximum volume level of 13), interactive sound settings, last selected mode, source and tuner presets will be retained in the player's memory.

Power Saving Automatic Standby

As a power-saving feature, the system automatically switches to Standby 30 minutes after a CD has reached the end and no control is operated.

Adjusting volume and sound

- 1 Press **VOLUME +/- (VOL +/-)** on the remote to decrease or increase the volume.
→ Display shows the volume level VOL and a number from MIN1, 2, ...30, 31 MAX.
 - 2 Press **DSC** on the remote repeatedly to select the desired sound effect: **ROCK/ JAZZ/ POP/ CLASSIC**.
 - 3 Press **DBB** on the remote to switch bass enhancement on or off.
→ Display shows: **DBB**.
 - 4 Press **IS** on the remote repeatedly.
→ If activated, **INCR SUR** is displayed.
→ If deactivated, **IS OFF** is displayed.
 - 5 Press **MUTE** on the remote to interrupt sound reproduction instantly.
→ Playback will continue without sound and the display shows **MUTE**.
- To activate sound reproduction you can:
 - press **MUTE** again;
 - adjust the volume controls;
 - change source.

Dimming the display screen

- Press **DIM** on the remote repeatedly to turn on or off the dim function for the display screen.

CD/MP3-CD Operation

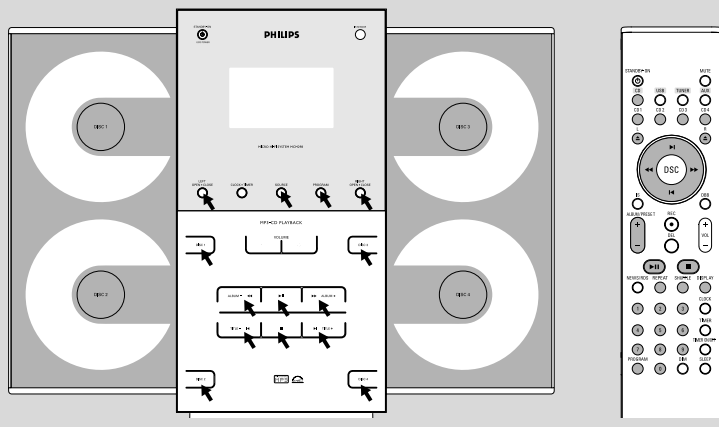

IMPORTANT!

- This system is designed for regular discs. Therefore, do not use any accessories such as disc stabiliser rings or disc treatment sheets, etc., as offered on the market, because they may jam the changer mechanism.
- Do not load more than one disc into each tray.
- The lens of the CD player should never be touched.

Discs for playback

This CD player plays Audio Discs including CD Recordables, CD-Rewritables and MP3 CD.

- CD-ROM, CD-I, CDV, VCD, DVD or computer CDs, however, are not possible.

About MP3 disc

Supported MP3 disc formats:

- ISO9660, Joliet, UDF 1.5
- Maximum title number: 256 (depending on filename length)
- Maximum album number: 99
- Supported sampling frequencies: 32 kHz, 44.1kHz, 48 kHz
- Supported Bit-rates: 32~256 (kbps), variable bitrates

Loading discs

- 1 Press **SOURCE** on the front panel of the system to select CD or press **CD** on the remote.
- 2 Press **LEFT OPEN • CLOSE** or **RIGHT OPEN • CLOSE** on the front panel (**L ▲** or **R ▲** on the remote) to open the left or right CD door respectively.
→ **OPEN** is displayed when the left or right CD door slides open.
- 3 Insert one or more discs with the printed side facing you. Press **LEFT OPEN • CLOSE** or **RIGHT OPEN • CLOSE** on the front panel (**L ▲** or **R ▲** on the remote) again to close the CD door.
→ **CLOSE** is displayed briefly. Then, the CD player will play all the discs in the four disc trays one by one starting from "DISC 1". If no disc is found in a disc tray, the CD player will automatically turn to the next one. In this case, **CHANGING** will be displayed briefly followed by **TOC READ**. If no disc is found in any of the four disc trays, **NO DISC** will be displayed.
→ **TOC READ** is displayed as the CD player scans the contents of a disc, and then the total number of tracks and playing time (or the total number of albums and tracks for MP3 disc) are shown.

Basic playback controls

To play currently available disc(s) on the disc trays

- Press **▶ ||** to start playback.
 - All loaded discs will play once, then stop.
 - The current track number and elapsed playing time of the track are displayed during disc playback.
 - For mixed mode discs, only one mode will be selected for playback depending on the recording format.

To play the selected disc only

- In CD mode, press **DISC 1/2/3/4 (CD 1/2/3/4)** on the remote).
 - The selected disc will play once, then stop.

To select a different track

- Press **TITLE +/- ◀ / ▶ (◀ / ▶)** on the remote) once or repeatedly until the desired track number appears in the display.
- If you have selected a track number shortly after loading a disc or in the PAUSE position, you will need to press **▶ ||** to start playback.

To select a desired album/title (MP3 disc only)

To select a desired album

- Press **ALBUM +/- ◀ ▶▶ALBUM/PRESET +/-** on the remote) repeatedly.
 - The album name will scroll through the display once.

To select a desired title

- Press **TITLE +/- ◀ / ▶ (◀ / ▶)** on the remote) repeatedly.
 - The title name will scroll through the display once.

Note:

– The album and title names will only be displayed once when selected. To view again, press the **DISPLAY** button repeatedly to display **ALBUM** and **TITLE** alternatively.

Text display during playback

In CD mode

- Press **DISPLAY** to see the following information:
 - Current track number and elapsed playback time of the current track.
 - Current track number and remaining playback time of the current track.
 - Current track number and total remaining playback time of the whole disc.

In MP3-CD mode

- Press **DISPLAY** repeatedly to show the current file and album names.

To find a passage within a track

- 1 Press and hold down on **ALBUM +/- ◀▶▶▶** (◀▶▶▶ on the remote).
 - The disc is played at high speed and low volume.
- 2 When you recognize the passage you want, release **ALBUM +/- ◀▶▶▶** (◀▶▶▶ on the remote).
 - Normal playback continues.

To replace discs during playback

- During playback of a disc in "DISC 1" or "DISC 2", you can press **RIGHT OPEN • CLOSE (R ▲)** on the remote) to open the right CD door to replace discs without affecting the current playback.
- During playback of a disc in "DISC 3" or "DISC 4", you can press **LEFT OPEN • CLOSE (L ▲)** on the remote) to open the left CD door to replace discs without affecting the current playback.

To interrupt playback

- Press **▶ ||** during playback.
 - The display freezes and the elapsed playing time flashes when playback is interrupted.
 - To resume, press **▶ ||** again.

To stop playback

- Press **■**.

CD/MP3-CD Operation

Notes:

- CD playback will also stop when;
 - the CD door where the disc is playing is opened.
 - you select another source: TUNER or AUX.
 - you select standby.
 - the set auto off time is out.
 - no button is pressed within 15 minutes in the CD PAUSE position.

Different play modes: SHUFFLE and REPEAT

You can select and change the various play modes before or during playback. The REPEAT modes can also be combined with PROGRAM.

- SHUF tracks of the entire disc are played in random order.
- REP ALL repeats the entire disc/ program.
- REP plays the current track continuously.

- To select your play mode, press **SHUFFLE** or **REPEAT** on the remote control before or during playback until the display shows the desired function. (SHUF, REP, REP ALL)
 - Press **▶ ||** to start playback if in the STOP position.
→ If you have selected SHUFFLE, playback starts automatically.
 - To return to normal playback, press the respective **SHUFFLE** or **REPEAT** button until the various SHUFFLE / REPEAT modes are no longer displayed.
- You can also press **■** to cancel your play mode.

Programming track numbers

Programming tracks is possible when playback is stopped. Up to 40 tracks can be stored in the memory in any order.

- Load the desired discs on the disc tray (refer to "Loading discs").
- Press **DISC 1/2/3/4 (CD 1/2/3/4)** on the remote to select a disc.
- Press **PROGRAM** to start programming.
→ **PROG** starts flashing.
- Press **TITLE +/- ◀ / ▶ (◀ / ▶)** on the remote) repeatedly to select the desired track.

- For MP3 disc, press **ALBUM +/- ◀ ▶ (ALBUM/PRESET +/- on the remote)** and **TITLE +/- ◀ / ▶ (◀ / ▶ on the remote)** to select the desired album and title for programming.

- Press **PROGRAM** to store the track.
- To end programming, press **■ once**.
→ **PROG** stays and the programme mode remains active.
→ The total number of tracks programmed and the total playing time are displayed.
→ For MP3 disc, total playing time will not be shown.
- To start program play, press **▶ ||**.

Notes:

- It is not possible to create a programme with MP3 tracks from multiple CDs, or combined with normal audio tracks.
- If the total playing time is more than "99:59" then "--:--" is displayed instead of the total playing time.
- If you attempt to programme more than 40 tracks, "PROGRAM FULL" is displayed.
- During programming, if no button is pressed within 20 seconds, the system will exit the programme mode automatically.

To review the program

- Stop playback and press **TITLE +/- ◀ / ▶ (◀ / ▶ on the remote)** repeatedly.
- To exit review mode, press **■**.

Erasing the program

- Press **■ once** when playback is stopped or **twice** during playback.
→ **PROG** disappears and "PROGRAM CLEARED" is displayed.

Note:

- The program will be erased when the system is disconnected from the power supply or when the disc tray is opened.

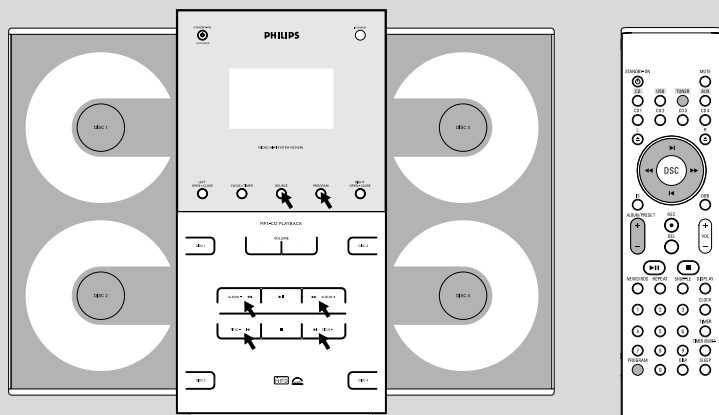

Tuning to radio stations

- 1 Press **SOURCE** on the front panel of the system repeatedly or **TUNER** on the remote to select TUNER.
→ TUNER is displayed briefly.
- 2 Press **SOURCE** on the front panel of the system or **TUNER** on the remote once or more to select your waveband (FM/AM).
- 3 Press and hold **ALBUM +/- << / >> (<< / >>)** on the remote).
→ The radio automatically tunes to a station with sufficient reception. Display indication during automatic tuning: SEARCH.
- 4 Repeat step 3 if necessary until you find the desired station.
- To tune to a weak station, press **ALBUM +/- << / >> (<< / >>)** on the remote) briefly and repeatedly until you have found optimal reception.

Programming radio stations

You can store up to a total of 40 radio stations in the memory for each band.

Automatic programming

Automatic programming will start with a chosen preset number. From this preset number upwards, former programmed radio stations will be overridden.

- 1 Press **TITLE +/- < / >** (**ALBUM/PRESET +/-** on the remote) to select the preset number where programming should start.

Note:

– If no preset number is selected, default is preset (1) and all your presets will be overridden.

- 2 Press **PROGRAM** for more than 2 seconds to activate programming.
→ AUTO is displayed and available stations are programmed in order of waveband reception strength: FM followed by AM. The last preset automatically stored will then be played.

Radio Reception

Manual programming

- 1 Tune to your desired station (see "Tuning to radio stations").
 - 2 Press **PROGRAM** to activate programming.
 - 3 Press **TITLE +/- ◀ / ▶ (ALBUM/PRESET +/-** on the remote) on the remote to allocate a number from 1 to 40 to this station.
 - 4 Press **PROGRAM** again to confirm the setting.
→ The preset number and the frequency of the preset station are shown.
 - 5 Repeat the above four steps to store other stations.
- You can override a preset station by storing another frequency in its place.

Tuning to preset radio stations

- Press **TITLE +/- ◀ / ▶ (ALBUM/PRESET +/-** on the remote) until the desired preset station is displayed.

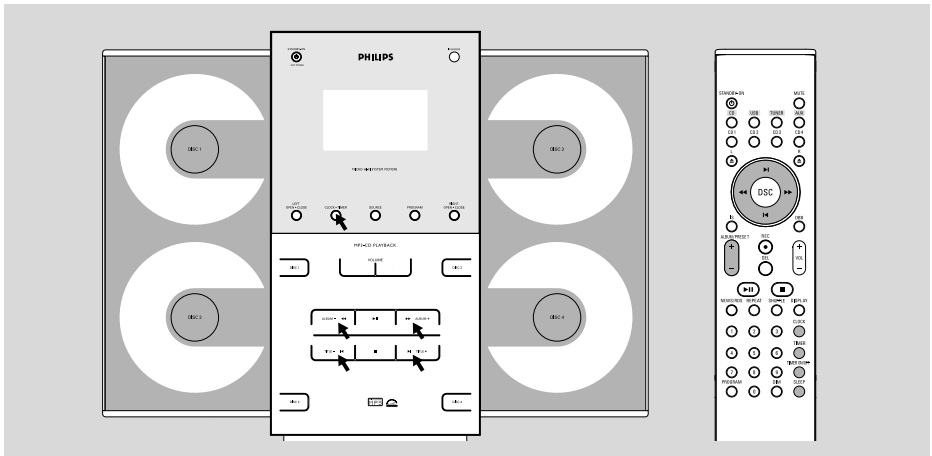

Clock setting

The system only supports 12-hour time mode.

- 1 In active mode, press **CLOCK•TIMER** (**CLOCK** on the remote) repeatedly until the time digits flash.
- 2 Press **ALBUM-/+** **◀◀ ▶▶◀◀ ▶▶** on the remote) repeatedly to set the hour.
- 3 Press **TITLE -/+ ◀ / ▶** (**ALBUM/PRESET +/-** on the remote) repeatedly to set the minute.
- 4 Press **CLOCK•TIMER** (**CLOCK** on the remote) again to store the setting.
→ The clock starts working.

To exit without storing the setting

- Press **■** on the system.

Notes:

- The clock setting will be cancelled when the power cord is disconnected or if a power failure occurs.
- During clock setting, if no button is pressed within 70 seconds, the system will exit clock setting mode automatically.

Timer setting

The system can switch on to CD or TUNER mode automatically at a preset time, serving as an alarm to wake you up.

IMPORTANT!

– Before setting the timer, ensure that the clock is set correctly.

- 1 Press and hold **CLOCK•TIMER** on the front panel of the system for more than **two seconds** or press **TIMER** on the remote to select timer mode.
→ The last timer setting starts flashing.
→ The selected source will be lighted.
- 2 Press **SOURCE** (**CD** or **TUNER** on the remote) to select the desired source.
- You can press **DISC 1/2/3/4** (**CD 1/2/3/4** on the remote) to select the specific disc you would like to play.
- Before setting timer, make sure the music source has been prepared.
CD – Load the disc(s). To start from a specific track, make a program (refer to "CD/MP3 CD Operation - Programming the disc tracks").
TUNER – tune to the desired radio station.
- 3 Press **ALBUM-/+** **◀◀ ▶▶◀◀ ▶▶** on the remote) repeatedly to set the hour for the timer to start.

Clock/Timer

- 4 Press **TITLE** +/- ◀ / ▶ (**ALBUM/PRESET** +/- on the remote) repeatedly to set the minute for the timer to start.
 - 5 Press **CLOCK•TIMER** (**TIMER** on the remote) to store the start time.
- At the preset time, the selected source will play.

To exit without storing the setting

- Press ■ on the system.

Notes:

- When the preset time is reached and the selected disc tray is empty, the next available disc will be selected. If all the disc trays are not available, Tuner will be selected automatically.
- During timer setting, if no button is pressed within 70 seconds, the system will exit timer setting mode automatically.

To deactivate the TIMER

- Press **TIMER ON/OFF** on the remote control.
→  will disappear from the display.

To activate the TIMER

- Press **TIMER ON/OFF** on the remote control.
→  will appear on the display.

Sleep timer setting

The sleep timer enables the system to switch to standby mode automatically at a preset time.

- 1 Press **SLEEP** on the remote control repeatedly to select a preset time.
→ The selections are as follows (time in minutes):
15 → 30 → 45 → 60 → OFF → 15 ...
- 2 When you reach the desired length of time, stop pressing **SLEEP**.
→ **ZZZ** is shown, except for "OFF" mode.
→ The sleep timer is now set.

To check the remaining length of time after sleep timer is activated

- Press **SLEEP** once.

To change the preset sleep timer

- Press **SLEEP** again while the remaining sleep timer is shown.
→ The display will show the next sleep timer options.

To deactivate the sleep timer

- Press **SLEEP** repeatedly until "OFF" is displayed, or press **STANDBY-ON/ECO POWER** .

Note:

- **ZZZ** will start flashing when the remaining length of time after activation of the sleep timer is less than 1 minute.

AMPLIFIER

Output power	2 × 15 W RMS
.....	2 × 30 MPO
.....	2 × 10W FTC ⁽¹⁾
Signal-to-noise ratio	≥ 62 dBA
Frequency response	63 – 16000 Hz, ± 3 dB
Input sensitivity AUX	600mV
Impedance loudspeakers	4 Ω
Impedance headphones	32 Ω -1000 Ω
(1) (4 Ω, 120-12.5 kHz, 10% THD)	<0.5W

CD PLAYER

Frequency range	65 – 16000 Hz
Signal-to-noise ratio	65 dBA
Total harmonic distortion	≤ 3%
Frequency response	63 – 12500 Hz (± 3 dB)

TUNER

FM wave range	87.5 – 108 MHz
AM wave range	530 - 1700 kHz
Antenna	
– FM	300 Ω Wire
– AM	Loop antenna

SPEAKERS

Bas reflex system	
Dimensions (w x h x d)	171 × 297 × 89 (mm)
.....	6.73" × 11.7" × 3.50" (inch)

GENERAL INFORMATION

AC Power	120V / 60 Hz
Dimensions (w x h x d) .	450 × 335 × 115 (mm)
.....	17.7" × 13.2" × 4.53" (inch)
Weight(with/without speakers)	6.5 / 4.2 kg
.....	2.9 / 1.86 pounds
Power consumption	
Active	80 W
Standby	<5 W
Eco power standby	<1 W

Specifications and external appearance are subject to change without notice.

Maintenance

Cleaning the Cabinet

- Use a soft cloth slightly moistened with a mild detergent solution. Do not use a solution containing alcohol, spirits, ammonia or abrasives.

Cleaning Discs

- When a disc becomes dirty, clean it with a cleaning cloth. Wipe the disc from the centre out.
- Do not use solvents such as benzene, thinner, commercially available cleaners, or antistatic spray intended for analogue records.

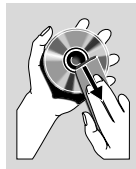

Cleaning the disc lens

- After prolonged use, dirt or dust may accumulate at the disc lens. To ensure good playback quality, clean the disc lens with Philips CD Lens Cleaner or any commercially available cleaner. Follow the instructions supplied with cleaner.

Troubleshooting

WARNING

Under no circumstances should you try to repair the system yourself, as this will invalidate the warranty. Do not open the system as there is a risk of electric shock.

If a fault occurs, first check the points listed below before taking the system for repair. If you are unable to remedy a problem by following these hints, consult your dealer or Philips for help.

Problem	Solution
"NO DISC" is displayed.	<ul style="list-style-type: none">✓ Insert a disc.✓ Check if the disc is inserted upside down.✓ Wait until the moisture condensation at the lens has cleared.✓ Replace or clean the disc, see "Maintenance".✓ Use a finalised CD-RW or a correct MP3-CD format disc.
Radio reception is poor.	<ul style="list-style-type: none">✓ If the signal is too weak, adjust the antenna or connect an external antenna for better reception.✓ Increase the distance between the Micro HiFi System and your TV or VCR.
The system does not react when buttons are pressed.	<ul style="list-style-type: none">✓ Remove and reconnect the AC power plug and switch on the system again.
Sound cannot be heard or is of poor quality.	<ul style="list-style-type: none">✓ Adjust the volume.✓ Disconnect the headphones.✓ Check that the speakers are connected correctly.✓ Check if the stripped speaker wire is clamped.✓ Make sure the MP3-CD was recorded within 32~256 kbps bit rate with sampling frequencies at 48 kHz, 44.1 kHz or 32 kHz.
The left and right sound outputs are reversed.	<ul style="list-style-type: none">✓ Check the speaker connections and location.
The remote control does not function properly.	<ul style="list-style-type: none">✓ Select the source (CD or TUNER, for example) before pressing the function button (▶▶, ◀◀, ▶).✓ Reduce the distance between the remote control and the system.✓ Insert the battery with its polarities (+/- signs) aligned as indicated.✓ Replace the battery.✓ Point the remote control directly toward IR sensor on the front of the system.
The timer is not working.	<ul style="list-style-type: none">✓ Set the clock correctly.✓ Press TIMER to switch on the timer.
The Clock/Timer setting is erased.	<ul style="list-style-type: none">✓ Power has been interrupted or the power cord has been disconnected. Reset the clock/timer.

How to mount your system onto wall

IMPORTANT!

- The wall mounting instructions are for use by the qualified wall mounting person only!
- Ask a qualified person to help you with the wall mounting, which includes drilling holes on the wall and mounting the set onto wall.

What's in the supplied mounting kit

1 x template

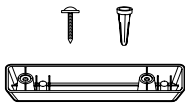
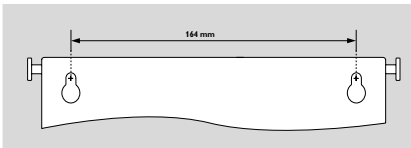

6 x screws and dowels

2 x speaker brackets

What else you'll need

- Drilling tools (e.g. an electric drill)

Preparation

- 1 Find a suitable location for mounting and complete necessary rear connections (see **Preparations**).
- 2 Ask a qualified person to help you with the wall mounting, who should:
 - to avoid unexpected damage, learn about the piping, wiring and other relevant information inside your wall;
 - according to the drilling requirements, choose suitable drilling tools;
 - take other precautions necessary for the wall mounting work.

Mounting your main unit onto wall

- 1 Align the template in the chosen location on a wall. Use a pencil to mark the drilling positions (as shown).

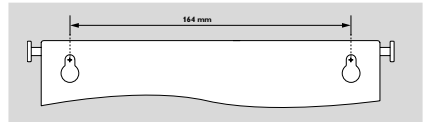

- 2 Drill two 6mm diameter holes as marked.
- 3 Secure the dowels and screws in the holes respectively, leaving the screws 5mm proud of the wall.

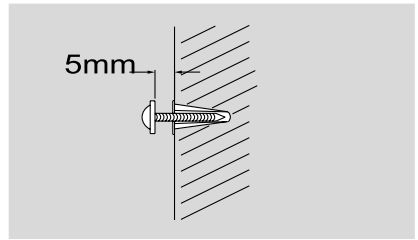

- 4 To detach the stand from the main unit,
 - a. As shown, hold down **PRESS**.
 - b. Move out the stand to detach.

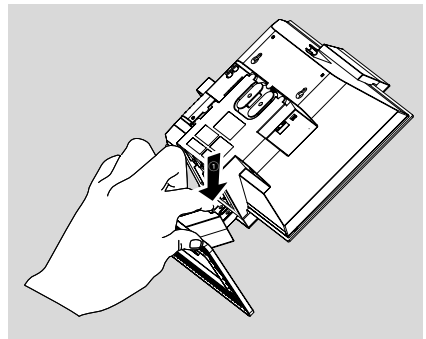

- 5 Hang the main unit on the fastening screws.

Mounting your speakers onto wall

The supplied speaker brackets enable you to mount your speakers onto wall too.

- 1 Position the brackets on the wall where you want to hang the speakers one by one. Drill 2 holes slightly undersized for each bracket to ensure a firm fit.
- 2 Secure each bracket on the wall using 2 dowels and 2 screws (supplied).

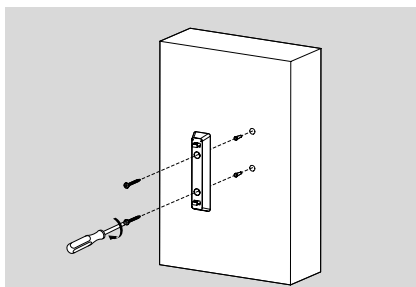

- 3 Detach the speaker stands in the same way as you do the main unit stand.

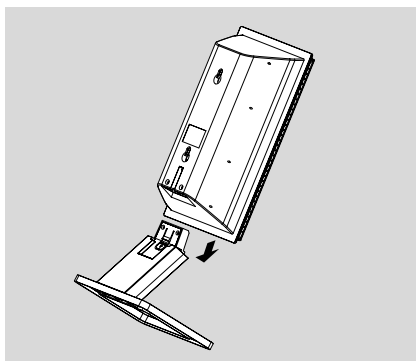

- 4 Hang the speakers on the brackets securely.

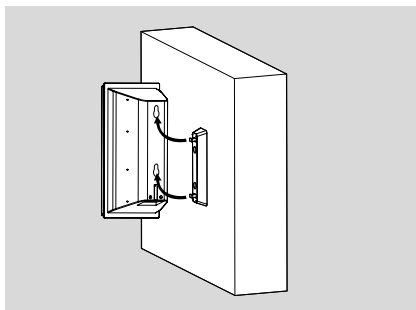

PHILIPS LIMITED WARRANTY ONE (1) YEAR

WARRANTY COVERAGE:

PHILIPS warranty obligation is limited to the terms set forth below.

WHO IS COVERED:

Philips warrants the product to the original purchaser or the person receiving the product as a gift against defects in materials and workmanship as based on the date of original purchase ("Warranty Period") from an Authorized Dealer. The original sales receipt showing the product name and the purchase date from an authorized retailer is considered such proof.

WHAT IS COVERED:

The Philips warranty covers new products if a defect arises and a valid claim is received by Philips within the Warranty Period. At its option, Philips will either (1) repair the product at no charge, using new or refurbished replacement parts, or (2) exchange the product with a product that is new or which has been manufactured from new, or serviceable used parts and is at least functionally equivalent or most comparable to the original product in Philips current inventory, or (3) refund the original purchase price of the product.

Philips warrants replacement products or parts provided under this warranty against defects in materials and workmanship from the date of the replacement or repair for ninety (90) days or for the remaining portion of the original product's warranty, whichever provides longer coverage for you. When a product or part is exchanged, any replacement item becomes your property and the replaced item becomes Philips' property. When a refund is given, your product becomes Philips' property.

Note: Any product sold and identified as refurbished or renewed carries a ninety (90) day limited warranty.

Replacement product can only be sent if all warranty requirements are met. Failure to follow all requirements can result in delay.

WHAT IS NOT COVERED - EXCLUSIONS AND LIMITATIONS:

This Limited Warranty applies only to the new products manufactured by or for Philips that can be identified by the trademark, trade name, or logo affixed to it. This Limited Warranty does not apply to any non-Philips hardware product or any software, even if packaged or sold with the product. Non-Philips manufacturers, suppliers, or publishers may provide a separate warranty for their own products packaged with the bundled product.

Philips is not liable for any damage to or loss of any programs, data, or other information stored on any media contained within the product, or any non-Philips product or part not covered by this warranty. Recovery or reinstallation of programs, data or other information is not covered under this Limited Warranty.

This warranty does not apply (a) to damage caused by accident, abuse, misuse, misapplication, or non-Philips product, (b) to damage caused by service performed by anyone other than Philips or Philips Authorized Service Location, (c) to a product or a part that has been modified without the written permission of Philips, or (d) if any Philips serial number has been removed or defaced, or (e) product, accessories or consumables sold "AS IS" without warranty of any kind by including refurbished Philips product sold "AS IS" by some retailers.

This Limited Warranty does not cover:

- Shipping charges to return defective product to Philips.
- Labor charges for installation or setup of the product, adjustment of customer controls on the product, and installation or repair of antenna systems outside of the product.
- Product repair and/or part replacement because of improper installation, connections to improper voltage supply, abuse, neglect, misuse, accident, unauthorized repair or other cause not within the control of Philips.
- Damage or claims for products not being available for use, or for lost data or lost software.
- Damage occurring to product during shipping.
- A product that requires modification or adaptation to enable it to operate in any country other than the country for which it was designed, manufactured, approved and/or authorized, or repair of products damaged by these modifications.
- A product used for commercial or institutional purposes (including but not limited to rental purposes).
- Product lost in shipment and no signature verification receipt can be provided.
- Failure to operate per Owner's Manual.

TO OBTAIN ASSISTANCE IN THE U.S.A., PUERTO RICO, OR U.S. VIRGIN ISLANDS...

Contact Philips Customer Care Center at:
1-888-PHILIPS (1-888-744-5477)

TO OBTAIN ASSISTANCE IN CANADA...

1-800-661-6162 (French Speaking)
1-888-PHILIPS (1-888-744-5477) - (English or Spanish Speaking)

REPAIR OR REPLACEMENT AS PROVIDED UNDER THIS WARRANTY IS THE EXCLUSIVE REMEDY FOR THE CONSUMER. PHILIPS SHALL NOT BE LIABLE FOR ANY INCIDENTAL OR CONSEQUENTIAL DAMAGES FOR BREACH OF ANY EXPRESS OR IMPLIED WARRANTY ON THIS PRODUCT, EXCEPT TO THE EXTENT PROHIBITED BY APPLICABLE LAW. ANY IMPLIED WARRANTY OF MERCHANTABILITY OR FITNESS FOR A PARTICULAR PURPOSE ON THIS PRODUCT IS LIMITED IN DURATION TO THE DURATION OF THIS WARRANTY.

Some states do not allow the exclusions or limitation of incidental or consequential damages, or allow limitations on how long an implied warranty lasts, so the above limitations or exclusions may not apply to you.

This warranty gives you specific legal rights. You may have other rights which vary from state/province to state/province.

Philips, P.O. Box 671539, Marietta, GA. 30006-0026

3121 233 48801