

# Quick start guide



Step A *Connect*

Step B *Setup*

Step C *Enjoy*

## What's in the Box?

You should find these items upon opening the box.

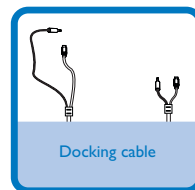
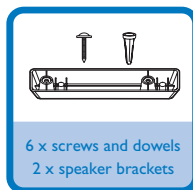
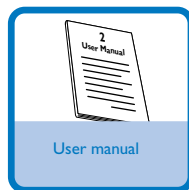
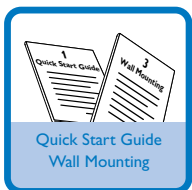
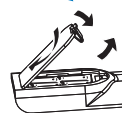
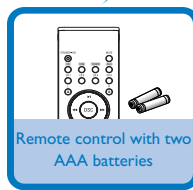
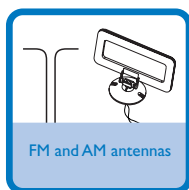
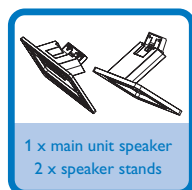

# Step A **Connect**

**1**  
Attach the supplied stands to the main unit and speakers respectively so that they can stand firmly on a desktop.

**2**  
Connect the speaker cables.

**3**  
Connect the AM and FM antennas.

**4**  
Connect the power cable of the system.

**Tip**  
– See the *User Manual* for how to connect other equipment to this system.  
– See *Wall Mounting* for detailed instructions if you want to mount the system on the wall.

**WARNING:** When you are holding the speakers for mounting them on the stands, please **DO NOT** press on the speaker cloth directly to avoid any speaker damage!

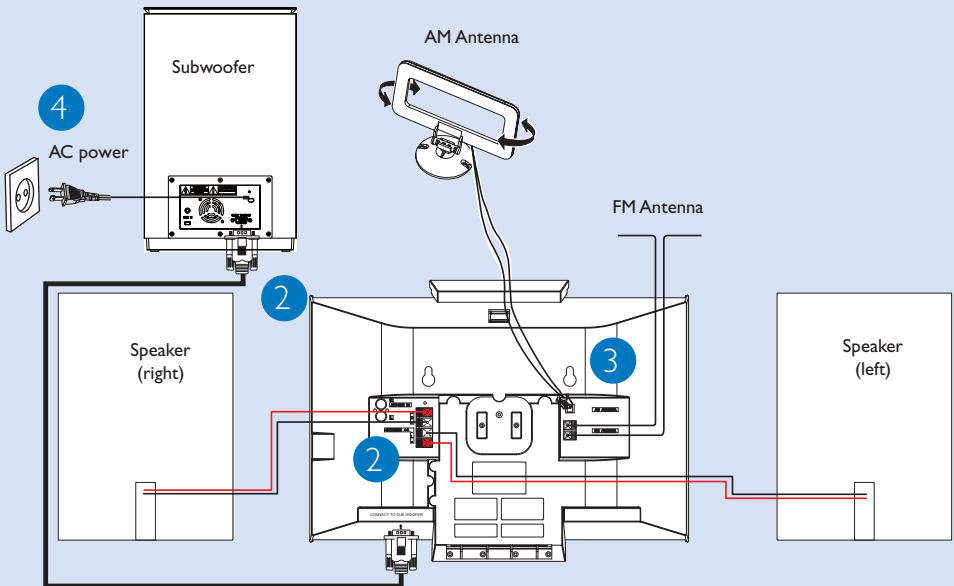
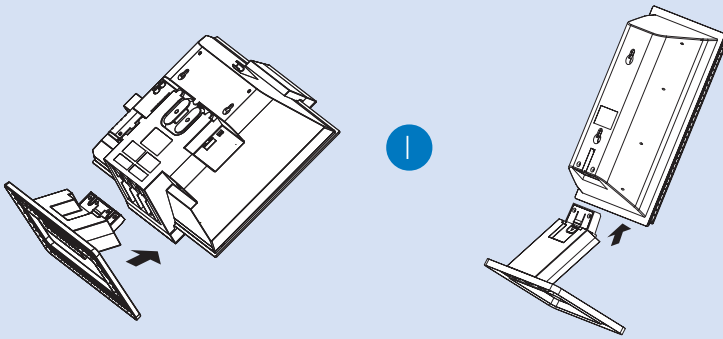

## Step B Setup

### Setting the clock

- 1 In active mode, press **CLOCK•TIMER** (**CLOCK** on the remote) repeatedly until the time digits flash.
- 2 Press **ALBUM•/+** **<< >>** (**<< >>** on the remote) repeatedly to set the hour.
- 3 Press **TITLE -/+** **◀▶** (**ALBUM/PRESET +/-** on the remote) repeatedly to set the minute.
- 4 Press **CLOCK•TIMER** (**CLOCK** on the remote) again to store the setting.

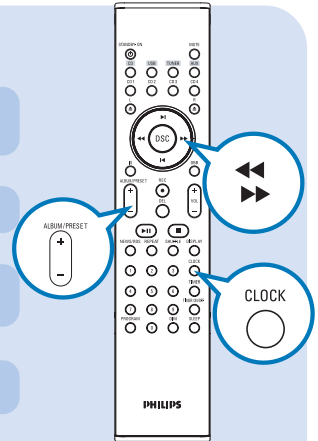

### Setting the timer

#### Important!

– Before setting the timer, ensure that the clock is set correctly.

- 1 Press and hold **CLOCK•TIMER** on the front panel of the system for more than two seconds or press **TIMER** on the remote to select timer mode.
- 2 Press **SOURCE** (**CD** or **TUNER** on the remote) to select the desired source.
- 3 Press **ALBUM/PRESET +/-** **<< >>** (**<< >>** on the remote) repeatedly to set the hour for the timer to start.
- 4 Press **TITLE -/+** **◀▶** (**ALBUM/PRESET +/-** on the remote) repeatedly to set the minute for the timer to start.
- 5 Press **CLOCK•TIMER** (**TIMER** on the remote) to store the start time.

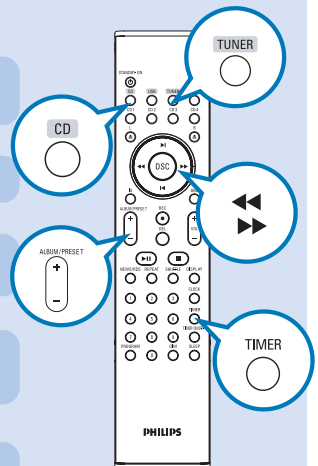

## Playing a disc

1

Press **LEFT OPEN • CLOSE** or **RIGHT OPEN • CLOSE** on the front panel (**L ▲** or **R ▲** on the remote) to open the left or right CD door respectively.

2

Insert one or more discs with the printed side facing you. Press **LEFT OPEN • CLOSE** or **RIGHT OPEN • CLOSE** on the front panel (**L ▲** or **R ▲** on the remote) again to close the CD door.

3

Use **DISC 1/2/3/4** (or **CD 1/2/3/4** on the remote control) to select a disc for playback.

→ Playback will start automatically. If not press **▶ ||**.

4

To stop playback, press **■**.

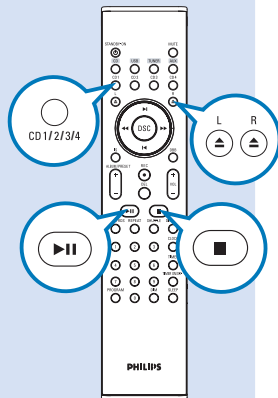

## Programming and tuning to radio stations

1

Press **SOURCE** on the front panel of the system repeatedly or **TUNER** on the remote to select the tuner source.

2

Press **PROGRAM** for more than two seconds to program all available stations in order of waveband.

3

Press **TITLE +/-** / **◀ / ▶** (**ALBUM/PRESET +/-** on the remote) until the desired preset station is displayed.

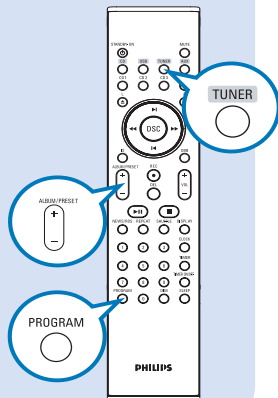

### Tip

Detailed playback features and additional functions are described in the accompany owner's manual.

