

Portable DVD player

PET1030

User manual



PHILIPS

1

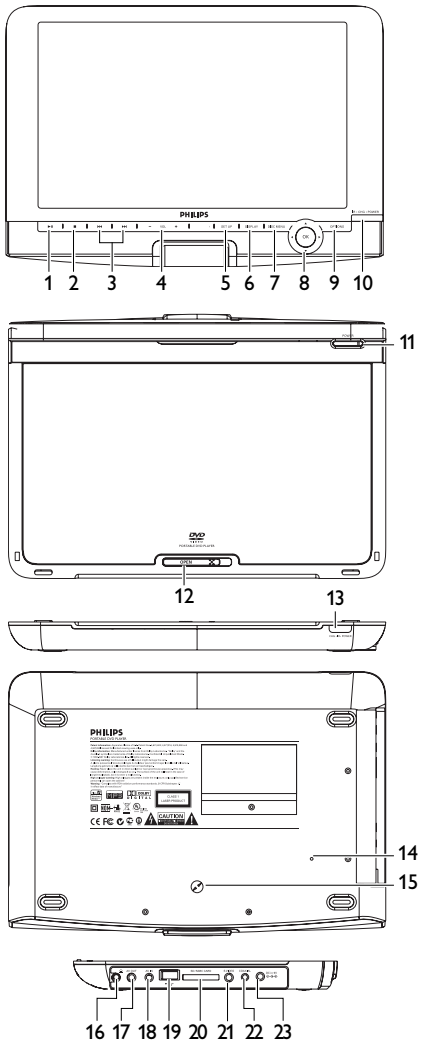

2

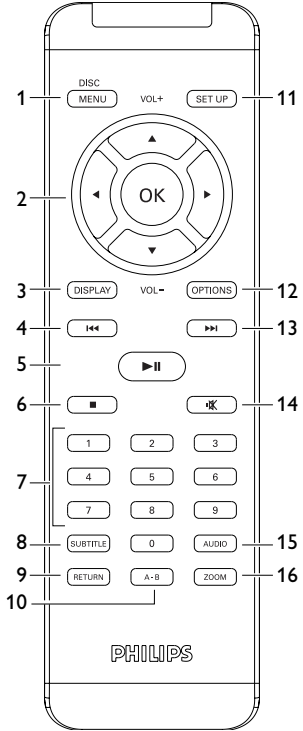

Content

1 Control elements and functional components

- 1.1 Main unit controls
- 1.2 Disc door
- 1.3 Front of player
- 1.4 Bottom of the player
- 1.5 Right of player
- 1.6 Remote Control
- 2 Introduction
 - 2.1 Your portable DVD player
 - 2.2 Unpacking
 - 2.3 Placement
 - 2.4 Playable disc formats
 - 2.4.1 DVD-Video
 - 2.4.2 Video CD
 - 2.4.3 Audio CD / MP3 CD / WMA CD
 - 2.4.4 CD with JPEG files
 - 2.4.5 DivX video discs
 - 2.4.6 About SD Memory Card
 - 2.5 Zero Bright Dot™
 - 2.6 Compatibility of the USB connection on this portable DVD player:
 - 2.6.1 Music:
 - 2.6.2 Picture:
 - 2.6.3 Video (vary with models):
- 3 General information
- 4 Charging the units
 - 4.1 Charge the DVD player
 - 4.2 Powering your remote control
- 5 Start up
 - 5.1 Setup
 - 5.2 Playback DVD
 - 5.3 Playback VCD
 - 5.4 Playback Super (S)-VCD
 - 5.5 Playback Music CD
 - 5.6 Playback Music MP3/WMA-CD
 - 5.7 Playback Picture-CD
 - 5.8 Playback from USB
- 6 Addition Functions
 - 6.1 DISPLAY Menu
 - 6.2 Connection
 - 6.2.1 Headphone
 - 6.2.2 TV
 - 6.2.3 AV input
 - 6.2.4 USB
 - 6.2.5 Coaxial
 - 6.2.6 SD/MMC card slot
 - 6.2.7 S Video
- 7 Troubleshooting
- 8 Technical data

1 Control elements and functional components

1.1 Main unit controls (see figure 1)

- 1 **▶||** Start / pause / resume playback
- 2 **■** Press once to stop playback and store the stop position. Press twice to stop playback completely.
- 3 **◀◀ / ▶▶** Search backward (◀◀) or search forward (▶▶)
- 4 **-VOL +** Volume control
- 5 **SETUP** Enter **SETUP** menu
- 6 **DISPLAY** Adjust the display value of the system
- 7 **DISC MENU** Display **MENU** page
- 8 **▲, ▼, ◀, ▶** Up / down / left / right cursor
- OK** Confirm selection
- 9 **OPTION** Access additional functions
- 10 **CHR·IR·POWER** Power / Remote sensor / charging indicator

1.2 Disc door (see figure 1)

- 11 **OPEN** Open disc door to insert or remove disc
- 12 **POWER** Switch the player on / off

1.3 Front of player (see figure 1)

- 13 **CHR·IR·POWER** Power / Remote sensor / charging indicator

1.4 Bottom of the player (see figure 1)

- 14 **Reset** Reset the player when it is hanged up
- 15 **Car mounting screw hole**

1.5 Right of player (see figure 1)

- 16 **🎧** Headphones jack
- 17 **AV OUT** Audio/Video output
- 18 **AV IN** Audio video input
- 19 **USB** USB connector
- 20 **SD/MMC card** Insert SD/MMC card
- 21 **S VIDEO** S video output
- 22 **COAXIAL** Digital audio output
- 23 **DC IN 9V** Power supply socket

1.6 Remote Control (see figure 2)

- 1 **MENU** Display **MENU** page
- 2 **▲, ▼, ◀, ▶** Up / down / left / right navigation key
- OK** Confirm selection
- VOL+ / -** Volume control
- 3 **DISPLAY** Adjust the display value of the system
- 4 **◀◀** Skip to previous chapter, track or title
- 5 **▶▶** Start / pause / resume playback
- 6 **■** Press twice to stop playback
- 7 **0 - 9** Numeric keypad
- 8 **SUBTITLE** Subtitle language selector
- 9 **RETURN** For VCD menu page
- 10 **A - B** To repeat or loop a sequence in a title
- 11 **SETUP** Enter **SETUP** menu
- 12 **OPTION** Access additional functions
- 13 **▶▶** Skip to next chapter, track or title
- 14 **🔇** Mute player volume
- 15 **AUDIO** Audio language selector
- 16 **ZOOM** Enlarge video image

CAUTION Use of controls or adjustments or performance of procedures other than herein may result in hazardous radiation exposure or other unsafe operation.

2 Introduction

2.1 Your portable DVD player

Your portable DVD player plays digital video discs conforming to the universal DVD Video standard. With it, you will be able to enjoy full-length movies with true cinema picture quality, and stereo or multichannel sound (depending on the disc and on your playback set-up).

The unique features of DVD-Video, such as selection of soundtrack and subtitle languages, and of different camera angles (again depending on the disc), are all included. What's more, parental lock lets you decide which discs your children will be able to see. You will find your player remarkably easy to use with the On-Screen Display and player display in combination with the remote control.

2.2 Unpacking

First check and identify the contents of your package, as listed below:

- Portable DVD player
- Remote Control (AY5507)
- Car adaptor (12V)
- User manual
- Travel bag
- AC power adaptor (AY4112/AY4134)

2.3 Placement

- Place the player on a firm, flat surface.
- Keep away from domestic heating equipment and direct sunlight.
- If the player cannot read CDs/DVDs correctly, try using a commonly available cleaning CD/DVD to clean the lens before taking the player to be repaired. Other cleaning methods may destroy the lens.
- Always keep the disc door closed to avoid dust on the lens.
- The lens may cloud over when the player is suddenly moved from cold to warm surroundings. It is then not possible to play a CD/DVD. Leave the player in a warm environment until the moisture evaporates.

2.4 Playable disc formats

In addition to DVD-Video disc, you will also be able to play all Video CDs, CDs, CDR, CDRW, DVD±R and DVR±RW.

2.4.1 DVD-Video

Depending on the material on the disc (a movie, video clips, a drama series, etc.) these discs may have one or more Titles, and each Title may have one or more Chapters. To make access easy and convenient, your player lets you move between Titles, and also between Chapters.



2.4.2 Video CD

Depending on the material on the disc (a movie, video clips, a drama series, etc.) these discs may have one or more Tracks, and tracks may have one or more indexes, as indicated on the disc case. To make access easy and convenient, your player lets you move between tracks and between indexes.



2.4.3 Audio CD / MP3 CD / WMA CD

Audio CDs / MP3 CD / WMA CD contain music tracks only. You can play them in the conventional way through a stereo system using the keys on the remote control and/or main unit, or via the TV using the On Screen Display (OSD).



2.4.4 CD with JPEG files

You can also view JPEG still photos on this player.

2.4.5 DivX video discs

DivX is a popular media technology created by DivX, Inc. DivX media files contain highly compressed video with high visual quality that maintains a relatively small file size. DivX files can also include advanced media features like menus, subtitles, and alternate audio tracks. Many DivX media files are available for download online, and you can create your own using your personal content and easy-to-use tools from DivX.com.



2.4.6 About SD Memory Card

SD Memory Card is a slim and compact bridge media linking various kinds of digital equipment through its easy connectivity. The card's control circuitry allows data to be read and written (in its protection area) only when appropriate external devices are detected. Using decoder software, an SD Memory Card-compatible device can play music, video clips and more without a drive mechanism like those in CD and DVD players.



2.5 Zero Bright Dot™

Enjoy highest-quality images that are free from annoying blank spots on the LCD screen. LCD displays commonly have imperfections, termed as 'bright dots' by the LCD industry. A limited number of bright dots were once considered an inevitable side effect of LCD mass production. With Philips' strict quality control procedures used in our Portable DVD Players, our LCD displays are produced with zero tolerance for bright dots. Select Portable DVD Players come with Philips Zero Bright Dot™ Policy to guarantee optimal screen quality.



Warranty service varies from region to region. Contact your local Philips representative for more detailed information.

2.6 Compatibility of the USB connection on this portable DVD player:



This portable DVD player supports most USB Mass storage devices (MSD) that are compliant to the USB MSD standards.

—Most common Mass storage class devices are flash drives, memory sticks, jump drives and etc.

—If you see a "Disc Drive" show up on your computer after you plugged the mass storage device into your computer, most likely it is MSD compliant and it will work with this portable DVD player.

If your Mass storage device required a battery / power source. Please make sure you have a fresh battery in it or charge the USB device first and then plug it into the portable DVD player again.

2.6.1 Music:

- This device only supports unprotected music with the following file extension:
.mp3
.wma (vary with model)
- Music bought from on-line music stores are not supported because they are secured by Digital Rights Management protection (DRM).

2.6.2 Picture:

- This device only support picture file with the following file extension:
.jpg

2.6.3 Video (vary with models):

- This device support DivX video files. The following file extension is:
.dixv, .dix

No Direct connection can be made from computer USB port to the portable DVD player even you have either or both mp3 or wma files in your computer.

3 General information

Power Sources

This unit operates on a supplied AC adaptor, car adapter, or a rechargeable battery pack.

- Make sure that the input voltage of the AC adaptor is in line with the local voltage. Otherwise, the AC adaptor and unit may be damaged.
- Do not touch the AC adaptor with wet hands to prevent electric shock.
- When connecting with car power (cigarette lighter) adaptor, be sure the input voltage of the adaptor is identical with car voltage.
- Unplug the AC adaptor from the outlet or remove the battery pack when the unit is not used for long periods of time.
- Hold the plug to disconnect the AC adaptor. Do not pull the power cord.

Please always use supplied AC/DC adaptor (AY4112/AY4134)

Safety and maintenance

- Do not disassemble the unit for laser rays are dangerous to eyes. Any service should be done by qualified service personnel.
- Unplug the AC adaptor to cut the power if liquid or objects get inside the unit.
- Take care not to drop the unit or subject it to strong shocks, which may cause malfunction.

Hearing Safety

Listen at a moderate volume.

- Using headphones at a high volume can impair your hearing. This product can produce sounds in decibel ranges that may cause hearing loss for a normal person, even for exposure less than a minute. The higher decibel ranges are offered for those that may have already experienced some hearing loss.
- Sound can be deceiving. Over time your hearing "comfort level" adapts to higher volumes of sound. So after prolonged listening, what sounds "normal" can actually be loud and harmful to your hearing. To guard against this, set your volume to a safe level before your hearing adapts and leave it there.



To establish a safe volume level:

- Set your volume control at a low setting.
- Slowly increase the sound until you can hear it comfortably and clearly, without distortion.

Listen for reasonable periods of time:

- Prolonged exposure to sound, even at normally "safe" levels, can also cause hearing loss.

- Be sure to use your equipment reasonably and take appropriate breaks.

Be sure to observe the following guidelines when using your headphones.

- Listen at reasonable volumes for reasonable periods of time.
- Be careful not to adjust the volume as your hearing adapts.
- Do not turn up the volume so high that you can't hear what's around you.
- You should use caution or temporarily discontinue use in potentially hazardous situations.
- Do not use headphones while operating a motorized vehicle, cycling, skateboarding, etc.; it may create a traffic hazard and is illegal in many areas.
- Important (for models with by-packed headphones): Philips guarantees compliance with the maximum sound power of its audio players as determined by relevant regulatory bodies only with the original model of provided headphones. In case this one needs replacement, we recommend that you contact your retailer to order a model identical to that of the original provided by Philips.
- Traffic safety: do not use while driving or cycling as you may cause an accident.
- Do not expose to excessive heat caused by heating equipment or direct sunlight.
- This product is not waterproof: do not allow your player to be submerged in water. Water entering the player may cause major damage.
- Do not use any cleaning agents containing alcohol, ammonia, benzene, or abrasives as these may harm the player.
- Apparatus shall not be exposed to dripping or splashing. Do not place any sources of danger on the apparatus (e.g. liquid filled objects, lighted candles)
- Do not touch the lens!

When the player is in use for a long period of time, the surface will be heated. This is normal.

Handling discs

- Do not attach paper or tape to the disc.
- Keep the disc away from direct sunlight or heat sources.
- Store the disc in a disc case after playback.
- To clean, wipe the disc outwards from the center with a soft, lint-free clean cloth.



On handling the LCD screen

The LCD is manufactured using high precision technology. You may, however, see tiny black points that continuously appear on the LCD. This is a normal result of the manufacturing process and does not indicate a malfunction.

Environmental information

We have reduced the packaging to its minimum and made it easy to separate into mono materials: cardboard, PS, PE and PET.

Your set consists of material which can be recycled if disassembled by a specialized company. Please observe the local regulations to dispose of packaging, exhausted batteries and old equipment.

Copyright information

"DivX, DivX" Certified, and associated logos are trademarks of DivX, Inc. and are used under license."

All other brand and product names are trademarks of their respective companies or organizations.

Unauthorized duplication of any recordings downloaded from the internet or made from CDs / VCDs / DVDs is a violation of copyright laws and international treaties.

The Windows Media and the Windows logo are registered trademarks of Microsoft Corporation in the United States and/or other countries.

4 Charging the units

4.1 Charge the DVD player

Plug in the AC/DC adaptor

- The **RED** LED indicates that charging is in progress. When the set is not in use, it will take about 4 hours to fully charge it. However, when in use, it will take more than 8 hours to fully charge it.*
- The **RED** LED will turn off when the set is fully charged. When the low battery icon appears on the screen, please charge the player.

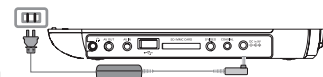

* Rechargeable batteries have a limited number of charge cycles and may eventually need to be replaced. Battery life and number of charge cycles vary by use and settings.

4.2 Powering your remote control

- 1 Open the battery compartment. Remove the protective plastic tab (first time users only).
- 2 Insert 1 x lithium 3V battery, type CR2025, then close the compartment.

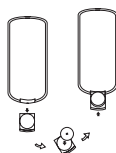

CAUTION

- Batteries contain chemical substances, so they should be disposed of properly.
- Danger of explosion if battery is incorrectly replaced. Replace only with the same or equivalent type.
- Incorrect use of batteries can cause electrolyte leakage and will corrode the compartment or cause the batteries to burst.
- Remove the batteries if the set is not to be used for a long time.
- Perchlorate Material – special handling may apply. See www.dtsc.ca.gov/hazardouswaste/perchlorate.

5 Start up

5.1 Setup

- 1 Press **SETUP**. A list of features is shown.

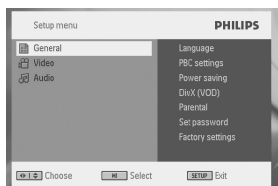

- 2 Use **▲** / **▼** to highlight your selection.
- 3 Use **◀** or **▶** to enter a sub-menu
- 4 Use the navigation keys to highlight your desired setting and press **OK** to confirm.
- 5 The **SETUP** menu includes:

General	
Language	Set On Screen Display (OSD) languages
PBC settings	Set Playback Control function ON/OFF. This feature is available for Super VCD.
Power save	Set Power Saving mode ON/OFF
DivX (VOD)	Get the DivX (Video-On-Demand) code
Parental	Set parental options
Set password	Change password (default: 9999)
Factory settings	Restore factory settings
Video	
TV Display	Set screen display aspect ratio
TV standard	Set video output format to TV system
Mpeg 4 subtitle	Select subtitle language for Mpeg 4 video, e.g. DivX video
Audio	
Dolby	Set Dolby output
Digital (SPDIF)	Set digital output format

5.2 Playback DVD



- 1 Briefly press **POWER** on the main control of the player to switch on the set.
- 2 Open the disc door and insert the disc.
- 3 The player will start to play the disc automatically.
- 4 Use navigation keys **◀**, **▶**, **▲**, **▼** to select an item from the DVD disc menu, such as play now, select languages and subtitle.
- 5 The following functions are available during playback:

Pause	Press ▶ to pause playback. You can resume playback by pressing ▶ again
Previous/Next	Briefly press ◀◀ or ▶▶ once or several times to select your desired chapters
Fast backward / Fast forward	Keep pressing ◀◀ or ▶▶ will search in fast speed, 2X, 4X, 6X... Then, press ▶ to resume normal playback
Volume Control	Press ▲ or ▼ briefly or repeatedly to increase or decrease the sound volume
Stop	Briefly press ■ on the right side of the player to stop playback
Subtitle	Change subtitle display. The function is available by pressing either the SUBTITLE or OPTIONS key
Language	Change language. The function is available by pressing either the AUDIO or OPTIONS key
Angle	Change the viewing angle provided in the DVD disc. The function is available by pressing the OPTIONS key.
Zoom	Zoom in the screen, and then use the navigation keys to pan the screen. The function is available by pressing either the ZOOM or OPTIONS key
A-B Repeat	Set repeat loop playback. Press A-B to set the starting point and press A-B again to set the ending point. Then, the player will repeat the loop playback. Press A-B to cancel the loop playback

5.3 Playback VCD



- 1 Briefly press **POWER** on the main control of the player to switch on the set.
- 2 Open the disc door and insert the disc.
- 3 The set will start to play the disc automatically.

- 4 The following functions are available during playback:

Pause	Press ▶ to pause playback. You can resume playback by pressing ▶ again
Previous/Next	Briefly press ◀◀ or ▶▶ once or several times to select your desired track
Fast backward / Fast forward	Keep pressing ◀◀ or ▶▶ will search in fast speed, 2X, 4X, 6X or 8X. Then, press ▶ to resume normal playback
Volume Control	Press ▲ or ▼ briefly or repeatedly to increase or decrease the sound volume
Stop	Briefly press ■ on the right side of the player to stop playback
Audio	Some VCDs only contain 2 languages for selection. You can change the language using this function. The function is available by pressing either the AUDIO or OPTIONS key
Zoom	Zoom in the screen, and then use the navigation keys to pan the screen. The function is available by pressing either the ZOOM or OPTIONS key
A-B Repeat	Set repeat loop playback. Press A-B to set the starting point and press A-B again to set the ending point. Then, the player will repeat the loop playback. Press A-B to cancel the loop playback

5.4 Playback Super (S)-VCD



(Super) Video CDs may feature **PBC (Play Back Control)**. This allows you to play the video CDs interactively, following the menu on the display.

- 1 Briefly press **POWER** on the main control of the player to switch on the set.
- 2 Insert the (S)VCD into the disc slot on the right side of the player. If **PBC** is on, the disc index menu will appear on the screen.
- 3 Use numeric keypad 0-9 to input your selection or select a play option.
- 4 Press **RETURN** on the remote control to return to the previous menu.
- 5 To turn Playback Control mode on/off, please go to **SETUP** and select **PBC settings**.

5.5 Playback Music CD



- 1 Briefly press **POWER** on the main control of the player to switch on the set.
- 2 Open the disc door and insert the disc.
- 3 The set will start to play the disc automatically.
- 4 The following functions are available during playback:

Pause	Press ▶ to pause playback. You can resume playback by pressing ▶ again
Previous/Next	Briefly press ◀◀ or ▶▶ once or several times to select your desired track
Fast backward / Fast forward	Keep pressing ◀◀ or ▶▶ will enter the fast search mode. Then, press ▶ will change the searching speed to 2X, 4X, 6X, 8X, 16x or 32x.
Volume Control	Press ▲ or ▼ briefly or repeatedly to increase or decrease the sound volume
Repeat	Press OPTIONS key to select Repeat 1 track or Repeat all tracks
Shuffle	Press OPTIONS key to turn shuffle playback on or off
Stop	Briefly press ■ on the right side of the player to stop playback

5.6 Playback Music MP3/WMA-CD



- 1 Briefly press **POWER** on the main control of the player to switch on the set.
- 2 Open the disc door and insert the disc.
- 3 The set will start to play the disc automatically.
- 4 Use navigation keys to select the folder and MP3/WMA file to be played.

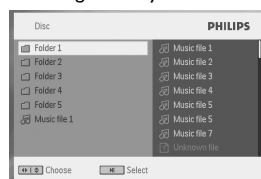

- 5 The following functions are available during playback:

Pause	Press ▶ to pause playback. You can resume playback by pressing ▶ again
Previous/Next	Briefly press ◀◀ or ▶▶ once or several times to select your desired track
Fast backward / Fast forward	Keep pressing ◀◀ or ▶▶ will search in fast speed, 2X, 4X, 6X or 8X. Then, press ▶ to resume normal playback
Volume Control	Press ▲ or ▼ briefly or repeatedly to increase or decrease the sound volume
Repeat	Press OPTIONS key to select Repeat 1 track or Repeat all tracks
Shuffle	Press OPTIONS key to turn shuffle playback on or off
Stop	Briefly press ■ on the right side of the player to stop playback

5.7 Playback Picture-CD



The player can only read pictures in JPEG format.

- 1 Briefly press **POWER** on the main control of the player to switch on the set.
- 2 Open the disc door and insert the disc.
- 3 The set will start to play the disc automatically.

4 Use navigation keys to select the folder and JPEG file to be played.

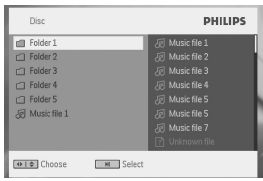

5 The following functions are available during playback:

- Pause** Press **II** to pause playback. You can resume playback by pressing **II** again.
- Previous/Next** Briefly press **II** or **II** once or several times to select your desired track.
- Rotate** Press **OPTIONS** key to select rotate mode. Then, use **◀** to rotate the picture clockwise. Use **▶** to rotate the picture anti-clockwise. Press **OPTIONS** key to exit rotate mode.
- Zoom** Zoom in the screen, and then use the navigation keys to pan the screen. The function is available by pressing either the **ZOOM** or **OPTIONS** key.
- Stop** Briefly press **■** on the right side of the player to stop playback.

6 At the end of the playback, press **■▲** to eject the disc from the player.

5.8 Playback from USB

This USB port supports the playback of JPEG / MP3 / WMA / DivX / MPG-4 files.

Transferring and recording of data from the DVD to the USB port is not possible.

- 1 Briefly press **POWER** on the main control of the player to switch on the set.
- 2 Insert a USB flash drive or USB memory card reader into the USB port.

The USB plug-in storage only support Mass Storage (MSC) device. It does not support support Hard Disk USB storage device and storage in MTP (Music Transfer Protocol) format.

3 The player will browse and show the contents in the USB flash device automatically.

The DVD player will take some time to browse the content of your USB flash drive. The browsing time will vary for memory capacity and the number of content in your USB drive.

4 Use navigation keys to select the file you want to access, then press **OK** to play it.

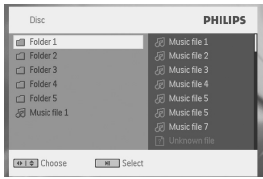

5 At the end of the playback, unplug the USB flash drive or USB memory card from the player.

To deactivate the USB browser or want to switch to DVD playback, simply unplug the USB connection.

6 Addition Functions

6.1 DISPLAY Menu

When you press **DISPLAY** during playback, the following menu will appear and you can access the corresponding function and information:



- Brightness** It allows you to adjust the brightness of the screen.
- Contrast** It allows you to adjust the contrast of the screen.
- Color** It allows you to adjust the color of the screen from cool, warm and normal.
- Turn off LCD** You can turn off the screen in some situations, such as when connected to TV or playing music discs. This can save the battery power.
- Battery level** It shows the battery level.

6.2 Connection

6.2.1 Headphone

Connect the headphones into the jack of your set.



6.2.2 TV

You can connect the player to a TV and enjoy your DVD.

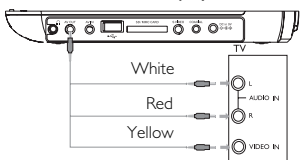

6.2.3 AV input

You can connect to other devices such as Digital Video Recorder, Digital Camera, etc.

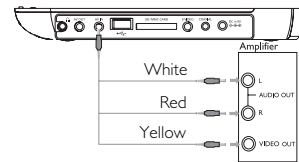

The video input devices, such as video amplifier, digital video recorder, digital camera should have the RCA output connection on the device. If your device does not have the RCA output, please consult your dealer.

6.2.4 USB

You can plug in the USB flash drive to view the stored pictures and video.

- 1 After plug in the USB flash drive, the DVD player will browse the content of your USB drive automatically.
- 2 See section 5.8 Playback from USB for playback details.
- 3 Unplug the USB drive after enjoyment. This will also deactivate the USB browser function.

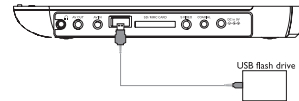

6.2.5 Coaxial

It provides digital audio output signal that you can connect to your home theater equipment to decode the digital audio signal.

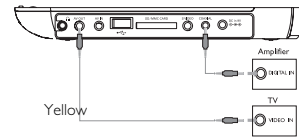

6.2.6 SD/MMC card slot

You can play video/audio/picture files stored in an SD/MMC card by inserting it into the SD/MMC CARD slot.

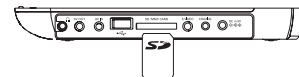

On the DVD player panel, press the **SOURCE** key repeatedly (or SD/MMC CARD on the remote) to select the SD/MMC source.

TIP Make sure the metal contact of the card to be inserted is facing down.

6.2.7 S Video

On the DVD player panel, press **VIDEO OUT** to select A/V OR S-VIDEO OUT.

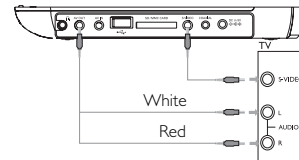

7 Troubleshooting

If it appears that the DVD-Video player is faulty, first consult this checklist. It may be that something has been overlooked.

WARNING Under no circumstances should you try to repair the set yourself as this will invalidate the guarantee.

If a fault occurs, first check the points listed, before taking the set for repair. If you are unable to solve a problem by following these hints, consult your dealer or service centre.

Symptom	Remedy
No power	<ul style="list-style-type: none"> • Check if both plugs of the mains cord are properly connected. • Check if there is power at the AC outlet by plugging in another appliance. • Check if battery pack is inserted appropriately. • Check if car adaptor is connected appropriately.
Distorted picture	<ul style="list-style-type: none"> • Check the disc for fingerprints and clean with a soft cloth, wiping from centre to edge. • Sometimes a small amount of picture distortion may appear. This is not a malfunction.
Completely distorted picture / no colour in the TV screen	The NTSC/PAL setting may be in the wrong status. Match your TV's setting with the player's setting.
No sound	Check audio connections. If using a HiFi amplifier, try another sound source.
Disc can't be played	<ul style="list-style-type: none"> • Ensure the disc label is upwards. • Clean the disc. • Check if the disc is defective by trying another disc.
The player does not respond to the remote control	Aim the remote control directly at the sensor on the front of the player. Avoid all obstacles that may interfere with the signal path. Inspect or replace the batteries.

Symptom	Remedy
Distorted or B/W picture with DVD	Use only discs formatted according to the TV-set used (PAL/NTSC).
No audio at digital output	<ul style="list-style-type: none"> • Check the digital connections.
Player does not respond to all operating commands during playback	<ul style="list-style-type: none"> • Operations are not permitted by the disc. • Refer to the instructions in the disc inlay.
Cannot detect USB plug-in	<ul style="list-style-type: none"> • Unplug the USB connection and plug-in again. Detection may take some time that vary with the capacity of your USB device. • The DVD player only support Mass Storage (MSC) format from USB flash drive. • The DVD player does not support Hard Disk storage or Media Transfer Protocol (MTP) format.
Cannot switch to AV-in or no signal	<ul style="list-style-type: none"> • Unplug the AV-in connection and plug-in again. • Check the connection from the AV output device, such as digital camera, video recorder, etc. • Use the provided AV cable for connection.
Switch between DVD/USB/AV-in	<ul style="list-style-type: none"> • DVD mode is default source during the DVD player power on. • Plug in USB will activate USB mode. Deactivate it by unplug the connection. • Plug in AV-in will activate AV-in mode. And deactivate it by unplugging the connection. • Do not plug-in USB & AV-in at the same time. Plug-in one type connection at a time only. • Unplug the connection before you plug-in another connection.
Player feels warm	When the player is in use for a long period of time, the surface will be heated. This is normal.
Display goes dimmer when AC is unplugged	The unit is saving power to ensure longer playtime with battery. It is normal. Adjust the brightness in the SETUP menu.
Player feels warm	When the player is in use for a long period of time, the surface will be heated. This is normal.

This set complies with the radio interference requirements of the European Union.

8 Technical data

Dimensions	27 x 19 x 3.8 cm 10.6 x 7.5 x 1.5 inches
Weight	1.5 kg / 3.3 lb
Power supply	DC 9V 2.2A
Power Consumption	≤ 20W
Operating temperature range	0 - 50°C (32 - 122°F)
Laser wavelength	650nm
Video system	NTSC / PAL / AUTO

PHILIPS reserves the right to make design and specification changes for product improvement without prior notice.

Modifications not authorized by the manufacturer may void users authority to operate this device.

All rights reserved.

Copyright information

The making of unauthorized copies of copy-protected material, including computer programmes, files, broadcasts and sound recordings, may be an infringement of copyrights and constitute a criminal offence. This equipment should not be used for such purposes.

Disposal of your old product



Your product is designed and manufactured with high quality materials and components, which can be recycled and reused.

When this crossed-out wheeled bin symbol is attached to a product, it means the product is covered by the European Directive 2002/96/EC.

Please be informed about the local separate collection system for electrical and electronic products.

Please act according to your local rules and do not dispose of your old product with your normal household waste. The correct disposal of your old product will help prevent potential negative consequences to the environment and human health.



**Be responsible
Respect copyrights**

Specifications are subject to change without notice.
Trademarks are the property of Koninklijke Philips Electronics N.V.
or their respective owners
2008 © Koninklijke Philips Electronics N.V. All rights reserved.

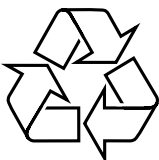

Printed in China

wk8021