



SA2300

SA2305

SA2310

SA2315

SA2320

SA2325

www.philips.com/support

For support call 0906 1010 017

Audio player

PHILIPS

Need help?

Please visit

www.philips.com/support

where you can access to a full set of supporting materials such as user manual, the latest software updates and answers to frequently asked questions.

Or call our Customer Care Helpline,

0906 1010 017 (£0.15/min)

where our professional support team will be pleased to assist you in solving any issues you may have with your player.

Country	Helpdesk	Tariff / min	Keep ready
Europe			
Austria	0820 901115	€0.20	Das Kaufdatum, Modellnummer und Serial nummer
Belgium	070 253 010	€0.17	La date d'achat la référence et le numéro de série du produit
Czech Republic	800142100	Místní tarif	Datum zakoupení, číslo modelu a sériové číslo
Denmark	35 25 87 61	Lokal tarif	Indkøbsdato, type-, model- og serienummer
Finland	09 2290 1908	Paikallispuhelumatksun hinta	Ostorpäivä ja tarkka mallinnumero ja sarjanumero
France	08 9165 0006	€0.23	La date d'achat la référence et le numéro de série du produit
Germany	0180 5 007 532	€0.12	Das Kaufdatum, Modellnummer und Serial nummer
Greek	0 0800 3122 1223	1 αστική μονάδα	Την ημερομηνία αγοράς και τον ακριβή κωδικό μοντέλου και τον αριθμό σειράς του προϊόντος σας
Hungary	06 80 018544	Helyi tarifa	A vásárlás dátuma, modell szám és szériaszám
Ireland	01 601 1161	Local tariff	Date of Purchase, Model number and Serial number
Italy	199 404 042	€0.25	La data di acquisto, numero di modello e numero di serie
Luxemburg	26 84 30 00	Tarifification locale	La date d'achat, la référence et le numéro de série du produit
Netherlands	0900 0400 063	€0.20	De datum van aankoop, modelnummer en serienummer
Norway	2270 8250	Lokal tariff	Dataoet da du kjøpte produktet & modellnummer & serienummeret
Poland	022 3491504	Cena połączenia lokalnego	Data zakupu, Numer modelu i numer serijny
Portugal	2 1359 1440	Preço local	A data de compra, número do modelo e número de série
Russia	(495) 961-1111 8 800 200-0880	по России звонок бесплатный	Дата покупки, Номер модели и Серийный номер
Slovakia	0800004551	Miestna tarifa	Dátum zakúpenia, číslo modelu a sériové číslo
Spain	902 888 785	€0,15	Fecha de compra y número del modelo y número de serie
Sweden	08 632 0016	Lokal kostnad	Inköpsdatum, modellnummer och serienummer
Switzerland	02 2310 2116	Ortstarif	Das Kaufdatum, Modellnummer und Serial nummer
UK	0906 1010 017	£0.15	Date of Purchase, Model number and Serial number
North America			
Canada	1-800-661-6162 (Francophone) 1-888-744-5477 (English / Spanish)	Free	Date of Purchase, Model number and Serial number
USA	1-888-744-5477	Free	Date of Purchase, Model number and Serial number
South America			
Argentina	11 4544 2047	Tarifa local	Fecha de compra y número del modelo y número de serie
Brazil	0800 701 02 03 (Except Sao Paulo) 2121 0203 (Sao Paulo)	Grátis Preço local	A data de compra, número do modelo e número de série
Chile	600 744 5477	Tarifa local	Fecha de compra y número del modelo y número de serie
Mexico	01 800 504 6200	Gratis	Fecha de compra y número del modelo y número de serie
Asia			
China	4008 800 008	本地费率	购买日期、型号及序号
Hong Kong	2619 9663	本地费率	購買日期、型號及序號
Korea	02 709 1200	관세	구매일자, 모델 번호, 시리얼 번호

Contents

1	Important safety information	4
2	Your new player	8
2.1	What's in the box	8
2.3	Register your product	8
3	Getting started	9
3.1	Overview of controls and connections	9
3.2	Install	9
3.3	Connect	10
3.3.1	Insert the battery	10
3.3.2	Read the battery level indication of your player	10
3.4	Transfer	10
3.4.1	Disconnect your player safely	11
3.5	Enjoy	11
3.5.1	Power on and off	11
3.5.2	Navigate the menu	11
4	Detail operation	12
4.1	Music mode	12
4.1.1	Control	12
4.1.2	Playback features	12
4.2	Radio*	13
4.2.1	Auto tune	13
4.2.2	Play a preset radio station and tune the station	13
4.2.3	Manual tune	14
4.2.4	Preset stations for each region	14
4.3	Recordings	14
4.3.1	Make recordings	14
4.3.2	Play back recordings	14
4.3.3	Upload recordings to the computer	15
4.3.4	Delete recordings	15
4.4	Settings	15
4.5	Use your player to store and carry data files	15
5	Upgrade your player	16
5.1	Manually verify whether your firmware is up to date	16
6	Technical data	17
8	Frequently asked questions	18
9	Glossary	20

* FM radio is only available to some regional version.

I Important safety information

General maintenance

To avoid damage or malfunction:

- Do not expose the player to excessive heat caused by heating equipment or direct sunlight.
- Do not drop your player or allow objects to fall on your player.
- Do not allow your player to be submerged in water. Do not expose headphone socket or battery compartment to water, as water entering the set may cause major damage.
- Do not use any cleaning agents containing alcohol, ammonia, benzene, or abrasives as these may harm the set.
- Active mobile phones in the vicinity may cause interference.
- Backup your files. Please ensure that you retain the original files you have downloaded to your device. Philips is not responsible for any loss of data if the product becomes damaged or not readable / legible.
- Manage (transfer, delete, etc.) your music files only with the supplied music software to avoid problems!

About operating and storage temperatures

- Operate in a place where temperature is always between 0 and 35°C (32 to 95°F)
- Store in a place where temperature is always between -20 and 45°C (-4 to 113°F)
- Battery life may be shortened in low temperature conditions.

Replacements parts/ accessories

Visit www.philips.com/support or www.philips.com/usasupport (for US residents) or contact our Customer Care Helpline (the telephone number can be found on the first page of this manual) to order replacement parts/ accessories.

Hearing Safety

Listen at a moderate volume.

- Using headphones at a high volume can impair your hearing. This product can produce sounds in decibel ranges that may cause hearing loss for a normal person, even for exposure less than a minute. The higher decibel ranges are offered for those that may have already experienced some hearing loss. 
- Sound can be deceiving. Over time your hearing “comfort level” adapts to higher volumes of sound. So after prolonged listening, what sounds “normal” can actually be loud and harmful to your hearing. To guard against this, set your volume to a safe level before your hearing adapts and leave it there.

To establish a safe volume level:

- Set your volume control at a low setting.
- Slowly increase the sound until you can hear it comfortably and clearly, without distortion.

Listen for reasonable periods of time:

- Prolonged exposure to sound, even at normally “safe” levels, can also cause hearing loss.
- Be sure to use your equipment reasonably and take appropriate breaks.

Be sure to observe the following guidelines when using your headphones.

- Listen at reasonable volumes for reasonable periods of time.
- Be careful not to adjust the volume as your hearing adapts.
- Do not turn up the volume so high that you can't hear what's around you.
- You should use caution or temporarily discontinue use in potentially hazardous situations.
- Do not use headphones while operating a motorized vehicle, cycling, skateboarding, etc.; it may create a traffic hazard and is illegal in many areas.

Important (for models supplied with headphones):

Philips guarantees compliance with the maximum sound power of its audio players as determined by relevant regulatory bodies only with the original model of provided headphones. In case this one needs replacement, we recommend that you contact your retailer to order a model identical to that of the original, provided by Philips.

Copyright information

All other brands and product names are trademarks of their respective companies or organizations.

Unauthorized duplication of any recordings whether downloaded from the Internet or made from audio CDs is a violation of copyright laws and international treaties.

The making of unauthorized copies of copy-protected material, including computer programmes, files, broadcasts and sound recordings, may be an infringement of copyrights and constitute a criminal offence. This equipment should not be used for such purposes.

The Windows Media and the Windows logo are registered trademarks of Microsoft Corporation in the United States and/or other countries.

Data logging

Philips is committed to improving the quality of your product and enhancing the Philips user experience. To understand the usage profile of this device, this device logs some info / data to the non-volatile memory region of the device. These data are used to identify and detect any failures or problems you as a user may experience while using the device. The data stored, for example, will be the duration of playback in music mode, duration of playback in turner mode, how many times battery low was encountered, etc. The data stored do not reveal the content or media used on the device or the source of downloads. The data stored on the device are retrieved and used **ONLY** if the user returns the device to the Philips service centre and **ONLY** to simplify error detection and prevention. The data stored shall be made available to user on user's first request.

Disposal of your old product



Your product is designed and manufactured with high quality materials and components, which can be recycled and reused.

When this crossed-out wheeled bin symbol is attached to a product, it means the product is covered by the European Directive 2002/96/EC.

Please be informed about the local separate collection system for electrical and electronic products.

Please act according to your local rules and do not dispose of your old product with your normal household waste. The correct disposal of your old product will help prevent potential negative consequences to the environment and human health.

Modifications

Modifications not authorized by the manufacturer may void user authority to operate this device.

Notice for USA

Note:

This equipment has been tested and found to comply with the limits for a Class B digital device, pursuant to part 15 of the FCC Rules. These limits are designed to provide reasonable protection against harmful interference in a residential installation. This equipment generates, uses, and can radiate radio frequency energy and, if not installed and used in accordance with the instruction manual, may cause harmful interference to radio communications.



However, there is no guarantee that interference will not occur in a particular installation. If this equipment does cause harmful interference to radio or television reception, which can be determined by turning the equipment off and on, the user is encouraged to try to correct the interference by one or more of the following measures:

- Relocate the receiving antenna.
- Increase the separation between the equipment and receiver.
- Connect the equipment into an outlet on a circuit different from that to which the receiver is connected.
- Consult the dealer or an experienced radio/ TV technician for help.

Notice for Canada

This Class B digital apparatus complies with Canadian ICES-003.

The set complies with the FCC-Rules, Part 15 and with 21 CFR 1040.10. Operation is subject to the following two conditions:

- This device may not cause harmful interference, and
- This device must accept any interference received, including interference that may cause undesired operation.

Notice for the European Union

This product complies with the radio interference requirements of the European Union.

2 Your new player

With your newly purchased player, you can enjoy the following:

- MP3 and WMA playback
- FM radio*
- Voice recording

2.1 What's in the box

The following accessories are included with your player:



Player



Headphones



USB extension
cable



AAA battery



Quick start guide



CD-ROM containing Philips Device Manager, User
Manual and Frequently Asked Questions

2.3 Register your product

We strongly recommend that you register your product in order to gain access to free upgrades. To register your product, please log on to www.philips.com/register or www.philips.com/usasupport (for US residents) so that we can inform you as soon as new updates become available.

* FM radio is only available to some regional version.

3 Getting started

3.1 Overview of controls and connections

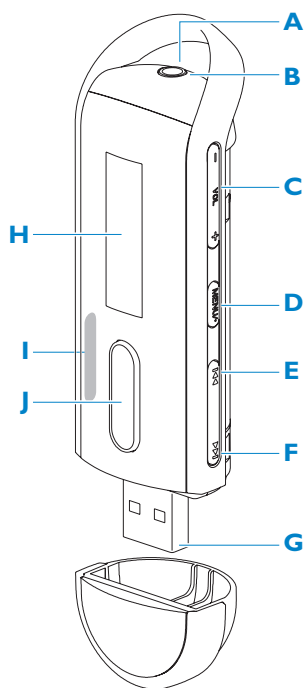

A	Headphones jack
B	Microphone
C - Vol +	Volume down / volume up
D MENU/REC	Press to access the menu / Return to previous menu Start or stop voice recording
E	Press to return to a previous song, press and hold to fast rewind. In menu mode, press to navigate through the menu.
F	Press to skip to the next song, press and hold to fast forward. In menu mode, press to navigate through the menu.
G	USB connector
H Display	Dynamically display menu, options and track information
I	Disable or enable the player's controls
J	Power on/off and play/pause, confirm a menu setting

3.2 Install

! **Important** Make sure to install the software provided in the supplied CD for music transfer.

System requirements:

- Windows XP, ME or 2000
- Pentium Class 300MHz processor or higher
- 128MB RAM
- 500MB hard disk space
- Internet connection (preferable)
- Microsoft Internet Explorer 6.0 or later
- USB port

1 Insert the CD supplied with your product into the CD ROM drive of your PC.

- 2 Follow the on-screen instructions to complete the installation of **Philips Device Manager**.
- 3 If the installation program does not start automatically, browse the CD contents with **Windows Explorer** and run the program by double clicking on the file ending with .exe.

Lost your CD? Don't worry, you can download the CD contents from www.philips.com/support or www.philips.com/usasupport (for U.S. residents).

3.3 Connect

3.3.1 Insert the battery



1 Remove the USB cap.

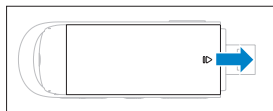

2 Remove the battery door by sliding it in the direction of arrow.

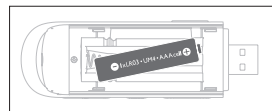

3 Insert the supplied AAA battery into the battery compartment.

3.3.2 Read the battery level indication of your player

The approximate power levels of your battery are indicated as follows:



Full



Two-thirds full



Half full



Low



Empty

Note When the batteries are almost empty, the low battery screen  blinks. Your player will power down in less than 60 seconds. Your player will save all settings and unfinished recordings before it powers down.

3.4 Transfer

Your player appears as a USB mass storage in **Windows Explorer**. You can organize files and transfer music to your player during USB connection.

- 1 Click and highlight one or more songs to transfer between your player and your computer.
- 2 Use drag and drop actions to complete your transfer.

✳ **Tip** To transfer music CDs to your player use software such as Musicmatch Jukebox or Windows Media Player, rip (convert) the songs on your music CD into MP3/WMA files. Copy the files into your digital audio player via Windows Explorer. Free versions of these programs can be downloaded from the internet.

✳ **Tip** Organize your music in folders. Your player support folder browsing so that you can organize your music by artists and albums. You can drag and drop entire folders to your player. You can also store your music outside the folder, you can play this music under the **Other songs** of folder menus or simply go to **shuffle all** to play all the musics stored inside and outside the folders.

3.4.1 Disconnect your player safely

Exit any active application working with your player. Remove your player safely by clicking  in the task tray shown in your PC.

3.5 Enjoy

3.5.1 Power on and off

To power on, press **▶||** until the Philips welcome screen appears.





To power off, press and hold **▶||** until there is no display on the screen.

✳ **Tip** Your player automatically powers down if there is no operation and no music played for 3 minutes.

3.5.2 Navigate the menu

Your player has an intuitive menu navigation system to guide you through various settings and operations. Use **◀◀** and **▶▶** to browse through menus. Press **▶||** to confirm your selection. You can press **MENU** to access the menu and return to previous level.

When your player powers up, you can see the Root menu. It includes:

 Music	Play your digital music tracks
 Radio	Listen to your radio presets
 Recordings	Play your recordings
 Settings	Change the playmode, equalizer or language settings, display the player information

4 Detail operation

4.1 Music mode (also applicable to playback of recordings)

4.1.1 Control

You can do the following action during music playback:

To	Do this
Play / Pause music	Press ►
Skip to next song	Press ►►
Return to previous song	Press ◀◀
Fast forward	Press and hold ►►
Fast rewind	Press and hold ◀◀
Return to browsing menu	Press MENU key
Increase volume	Press VOL +
Decrease volume	Press VOL -

From the main menu, select 🎵 to enter music mode.

You can search from the following music options:

Folder	▶ Folder	▶ Play alphabetically the songs per folder
	▶ Other songs	▶ Play alphabetically the songs outside folder
Shuffle all	▶ Shuffle all	▶ Play all songs randomly

 **Note** This player does not support copy right protected (Digital Rights Management – DRM) WMA songs bought from the Internet.

4.1.2 Playback features

Play modes

You can set your player to play songs either randomly or repeatedly.

- 1 Press MENU, select **Settings** and then select **Play modes**.
- 2 Press ◀◀ / ►► to browse through the different play modes (**Off**, **Repeat 1**, **Repeat all** and **Shuffle & repeat**).
- 3 Press ►|| to confirm your selection.

Icon	Meaning
Off	Normal playback
1-🔁 Repeat 1	Play one song repeatedly
🔁 Repeat all	Play all songs repeatedly
🔁 Shuffle & repeat	Play all songs randomly and repeatedly

 **Note** Playmodes are not available when playing recordings.

Sound settings

You can set your player to play music with different EQ (equalizers).

- 1 Press **MENU**, select **Settings**, then select **Sound settings**.
- 2 Press **◀◀** / **▶▶** to select between **Pop**, **Jazz**, **Rock**, **Classical** or **Off**.
- 3 Press **▶▶** to confirm your selection.

4.2 Radio*

From the main menu, select  to enter radio mode.

Connect the headphones

The supplied pair of headphones serves as a radio antenna. Make sure that it is properly connected to ensure optimal reception.

Select your FM region

From the main menu, select  > Radio settings.

Region	Frequency range	Tuning steps
America	87.5 - 108 MHz	0.1 MHz
Europe	87.5 - 108 MHz	0.05 MHz
Asia	87.5 - 108 MHz	0.05 MHz

4.2.1 Auto tune

- 1 Select **Auto tune** under Radio menu .
- > *The player will search for the stations with the strongest signals and automatically save them up to 10 maximum of presets channel.*

 **Tip** Stop auto tune by pressing any key except volume key.

4.2.2 Play a preset radio station and tune the station

- 1 From the Radio menu , select **Presets**.
- 2 Press **◀◀** or **▶▶** to browse and select the preset stations.
- 3 After you select a preset station, short press **◀◀** / **▶▶** can change to another preset stations.
- 4 You can also tune the frequency of selected preset station by long pressing **◀◀** / **▶▶** keys, the preset number will then go blink, short press **◀◀** or **▶▶** again to tune the frequency by step, long press to search next nearest strongest signal. To confirm and save the signal, press **▶▶**, or press **◀◀** / **▶▶** to search again.

* FM radio is only available to some regional version.

4.2.3 Manual tune

- 1 Manual tune under the radio menu offers you to directly tune the current / last played preset station.
- 2 The current / last played preset number will go blink after you enter this menu.
- 3 Short press ◀◀ or ▶▶ to tune the frequency by step (0.05MHz for Europe & Asia, 0.1MHz for USA)
- 4 Long press ◀◀ or ▶▶ to search the next nearest strongest signal.
- 5 To confirm and save the signal, press ▶||, or press ◀◀ / ▶▶ to search again as step 3 or 4 above.

4.2.4 Preset stations for each region

The player is capable to store the different set of preset station for each region. After select the region on the radio setting and save the preset station, those preset stations will be stored only in that region.

4.3 Recordings

Your player allows you to make voice recordings and play back your recordings.

4.3.1 Make recordings

- 1 Press and hold REC to start voice recording.
 - > Your player displays the recording progress.
- 2 Press and hold REC again to stop voice recording
 - > Your player displays the saving progress. Your voice recording will be saved on your player. (Filename format: VOICEXXX.WAV where XXX is the recording number which will be automatically generated.)

✳ **Tip** You can pause and resume a recording anytime with ▶|| key.

4.3.2 Play back recordings

You can find your recordings in the Recordings mode.

- 1 From the root menu, select 📁 to enter the Recordings mode. Your player will play all your recordings alphabetically and playback will start with the last recording made.
- 2 Press ▶|| to pause the recording on playback.
- 3 Press ◀◀ or ▶▶ to play the next or previous recordings.
- 4 Press and hold ◀◀ or ▶▶ to fast forward or fast rewind the current recording on playback.

4.3.3 Upload recordings to the computer

- 1 Connect your player to your computer.
- 2 Select your player in **Windows Explorer**.
> You will find a **Voice** folder. This folder contains the recordings.
- 3 Copy and paste the recordings to any desired location on the computer.

4.3.4 Delete recordings

Recordings can only be deleted on the computer.

- 1 Connect your player to your computer.
- 2 Select your player in **Windows Explorer**.
- 3 Double click the **Voice** folder.
- 4 Select the files you want to delete and press **Delete** on your computer keyboard.

4.4 Settings

You can set your preferences in your player to suit your needs.

- 1 Press **MENU** and select **SETTINGS**.
- 2 Press **◀◀** / **▶▶** to browse through the various options and press **▶||** to confirm your selection.
- 3 Press **MENU** to exit the current settings screen.

Settings	Further Options
Play mode	Off / Repeat 1 / Repeat all / Shuffle & repeat
Sound settings	Pop / Rock / Jazz / Classical / Off
Language	English / French / German / Spanish / Dutch / Italian / Portuguese / Polish / Swedish / Chinese Simplified / Chinese Traditional / Japanese / Korean / Russian
Information	FW (Firmware) version / Free space
Radio settings	America / Asia / Europe
Factory settings	Restore to default factory settings

4.5 Use your player to store and carry data files

You can use your player to store and carry data files by copying data files into your player with **Windows Explorer**.

5 Update your player

Your player is controlled by an internal program called the firmware. Newer versions of the firmware may have been released after you have purchased your player.

A software program called **Philips Device Manager** enables you to update the firmware on your device if a new firmware is available on your PC.

Install **Philips Device Manager** from the supplied CD or download the latest version from www.philips.com/support or www.philips.com/usasupport (for U.S. residents)

5.1 Manually verify whether your firmware is up to date

- 1 Connect your player to the computer.
- 2 Launch **Philips Device Manager** from **Start > Programs > Philips Digital Audio Player > SA23XX > Philips SA23XX Device Manager**.

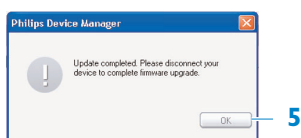
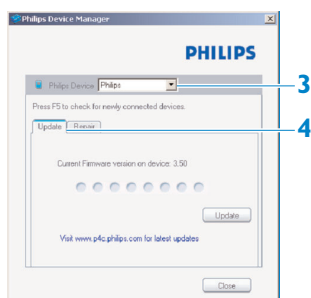

- 3 Make sure you are connected to the internet.
- 4 Click **Update**.
 - > **Philips SA23XX Device Manager** will check whether a new firmware is available on the Internet and install it on your player.
- 5 When **Update completed** appears on the screen, click **OK** and disconnect the player.
 - > A message **Updating firmware** will be displayed.

6 Technical data

Power

- Power supply: AAA alkaline battery*

Display

- Picture / Display: Mono display, 32 x 128 pixels

Sound

- Channel separation: 35dB
- Equalizer settings: Rock / Jazz / Pop / Classical / Off
- Frequency response: 80-18000Hz
- Signal to noise ratio: > 80dB
- Output Power (RMS): 2x3mW

Audio Playback

- Compression format: MP3 (8-320 kbps and VBR; Sample rate: 8, 11.025, 16, 22.050, 24, 32, 44.1, 48kHz), WMA (64-320kbps)
- ID3-tag support: Song title and artist name

Recording

- Audio Capturing: Built-in microphone (Mono)

Storage Media

- Built-in memory capacity:
SA230X 512MB NAND Flash +
SA231X 1GB NAND Flash +
SA232X 2GB NAND Flash +

Connectivity

- Headphone 3.5mm, USB 2.0++

Music transfer

- Drag and drop in Windows Explorer

* *Battery life vary by use and settings.*

+ *1MB = 1 million bytes; available storage capacity will be less.*

1GB = 1 billion bytes; available storage capacity will be less.

Full memory capacity may not be available as some memory will be reserved for the player.

Storage capacity based on 4 minutes per song and 64kbps WMA encoding.

++ *Actual transfer speed may vary based on your operating system and software configuration.*

System Requirements

- Windows® ME, 2000 or XP
- Pentium Class 300MHz processor or higher
- 128MB RAM
- 500MB hard disk space
- Internet connection
- Microsoft Internet Explorer 6.0 or later
- Video display card
- Sound card
- USB port

7 Frequently asked questions

If you encounter problems with your player, go through the following points listed in the next section. Please also check out FAQs at www.philips.com/support for further help and other troubleshooting tips.

Consult your dealer or service center if you are unable to find a solution by following these hints.

 **Warning** Under no circumstances should you try to repair the set yourself, as this will invalidate the warranty.

My player has no power or is locked up or seems dead.

- Your battery may have gone flat. Insert a new battery before use.
- You may have failed to press and hold **▶||** long enough. Press and hold **▶||** until the Philips welcome screen appears on display.
- Do a soft reset by re-inserting the battery.

If none of the above works, then you may have to use the Device Manager to recover your player:

- 1 Launch the **Philips Device Manager** at **Start > Programs > Philips Digital Audio Player > SA23XX > Philips SA23XX Device Manager** on your PC.
- 2 Connect your player to the PC.
- 3 **Device Manger** will acknowledges your player and goes into recovery mode. Follow the instructions given by the **Device Manager**.

There is no music on my player after transfer.

Are your songs in MP3 or WMA format?

Other formats will not playback on the player.

The player does not respond to any key press, and subsequently hangs or freezes.

Remove and insert the battery again.

There is no sound.

Make sure your headphones are inserted all the way into the headphones jack.

My player shows .

Switch **LOCK** slider to unlock the key press.

The player shows **Memory full!**

Connect your player to the computer. Delete unwanted files, disconnect safely and proceed with your record again.

Some songs do not show up or playback on the player.

- The audio file might be corrupted, try to playback the file on your PC first. If it does not play, rip the song again.
- Songs with bit rates higher than 320kbps are not supported by the player.
- This player does not support copyright protected (DRM) WMA tracks bought from on-line music stores, only unprotected WMA files can be played back on this player. The song is in a format that is not supported by the player. Only MP3, WMA are supported.

9 Glossary

A

Album

A collection list of songs.

D

Digital Rights Management (DRM)

A technology that provides a persistent level of protection to digital content by encrypting it with a cryptographic key. Authorized recipients (or end users) must acquire a license in order to unlock and consume the content.

M

MP3

An audio compression format known as MPEG-1 Audio Layer 3.

P

Playlist

A list of digital media contents.

R

Root menu

The main menu that sits on top of the user interface structure tree.

S

Songs

An individual track or a discrete piece of audio content.

T

Title

The largest unit of digital media content. For CD, it may be the name of the CD.

W

WAV

A digital media file format for storing sound.

Windows Media Audio (WMA)

An audio file in Windows Media Format. The audio content of the file is encoded with one of the Windows Media Audio codecs.

PHILIPS reserves the right to make design and specification changes for product improvement without prior notice.



Be responsible
Respect copyrights

Specifications are subject to change without notice.
Trademarks are the property of Koninklijke Philips
Electronics N.V. or their respective owners
© 2007 Koninklijke Philips Electronics N.V.
All rights reserved.
www.philips.com



print in china
wk7064