

Register your product and get support at
www.philips.com/welcome

SE659



US-EN

Telephone Answering Machine



Warning

Use only rechargeable batteries.

Charge the handset for 24 hours before use.

PHILIPS

Table of contents

1	Important Safety Instructions	4
2	Environment and safety	6
2.1	Safety information	6
2.2	Power requirements	6
2.3	Battery requirements	6
2.4	Telephone connection	6
2.5	Environmental care	7
2.6	Precautions	7
2.7	Equipment Approval Information	8
2.7.1	Notification to the Local Telephone Company	8
2.7.2	Rights of the Phone Company	8
2.8	Interference Information	9
2.9	Hearing Aid Compatibility (HAC)	10
2.10	FCC RF Radiation Exposure Statement	10
3	Important	10
3.1	Power requirements	11
3.2	Electric, Magnetic and Electromagnetic Fields ("EMF")	12
3.3	Recycle your batteries	12
4	The RBRC® seal	12
4.1	Service Centers	13
5	Your phone	14
5.1	What's in the box	14
5.2	Overview of your handset	15
5.3	Display icons and Messages	18
5.4	Overview of the base station	20
5.5	Base station display	22
6	Conventions Used in this Manual	22
7	Getting started	23
7.1	Connect the base station	23
7.2	Wall mounting the base	24
7.3	Install your phone	25
7.3.1	Install battery	25
7.3.2	Charge battery	25
7.4	Remove/Attach belt clip	26
7.5	Install optional headset	26
7.6	Power up	26
7.7	Using multipacks	27
7.8	Handset menu structure	28
8	Using your phone	33
8.1	Make a call	33
8.1.1	Predialling	33
8.1.2	Direct dialling	33
8.1.3	Call from redial list	33
8.1.4	Call from the call log	34
8.1.5	Call from the phonebook	34
8.1.6	Call from the phonebook while already on the phone	34
8.1.7	Call using Direct Access Memory	35
8.1.8	Enter a Dialing Pause	35
8.2	Answer a call	35
8.2.1	Handsfree answering with handset	35

8.3	Answer a call on the other line	36	9.9.3	Set Alarm (Handset only)	42
8.4	End a call	36	9.9.4	Set Alarm Tone (Handset only)	43
8.5	Using the Redial list	36	10	Using your Phonebook	43
8.5.1	Access Redial list	36	10.1	Store a contact in the phonebook	43
8.5.2	View redial number details	36	10.2	Access phonebook	44
8.5.3	Save a redial number into the phonebook	36	10.3	Modify a phonebook entry	44
8.5.4	Delete a redial number	37	10.4	Select phonebook melody (Handset only)	44
8.5.5	Delete all redial numbers	37	10.5	Delete a phonebook entry	45
9	Use more of your phone	38	10.6	Delete all phonebook entries	45
9.1	Switch the handset off/on	38	10.7	Direct Access Memory	45
9.2	Handset keypad lock/unlock	38	10.7.1	Add/Edit Direct Access Memory	45
9.3	Text or number entry	38	10.7.2	Delete Direct Access Memory	46
9.4	Call waiting	38	11	Using the Call log	46
9.5	Call in progress	38	11.1	Access the Call log	46
9.5.1	Adjust earpiece or speaker volume	39	11.1.1	To choose the format for call log display	47
9.5.2	Mute/Unmute microphone	39	11.2	Save call list entry into the phonebook	47
9.5.3	Activate/Deactivate handset loudspeaker mode	39	11.3	Delete a call list entry	47
9.6	Chain dialing	39	11.4	Delete all call list entries	48
9.7	Using the Intercom	39	12	Personal settings	48
9.7.1	Intercom another unit	39	12.1	Change the Handset Name (Handset only)	48
9.7.2	Transfer an external call to another unit	40	12.2	Ring Settings	48
9.7.3	Answer an external call during intercom	40	12.2.1	Set the Ring Volume	48
9.7.4	Switch between an internal and external call	40	12.2.2	Set the Ring Tones	49
9.7.5	Establish a three-party conference call	40	12.2.3	Activate/Deactivate Key Beep	49
9.8	Locate Handset	41	12.3	Change the Display Language	49
9.9	Clock and Alarm settings	42			
9.9.1	Set Date and Time	42			
9.9.2	Set Time and Date Format	42			

12.4	Select the Display Wallpaper (Handset only)	50	14.1.2	Set Voice Mail Number	60
12.5	Select the Color Theme (Handset only)	50	15	Telephone answering machine (TAM)	60
12.6	Set the Display Contrast	50	15.1	Playing Messages	61
12.7	Set the Backlight Time (Handset only)	51	15.1.1	Playback of messages via handset	61
12.8	Deactivate/Activate Auto Hang-Up (Handset only)	51	15.1.2	Functions available during playback	61
12.9	Changing the Line Setting (Base Station only)	51	15.2	Delete all messages from the handset	61
13	Advanced settings	52	15.3	Turn the Answering Machine On/Off from the Handset	62
13.1	Easy Call	52	15.4	Play, Record, or Delete an Outgoing Message	62
13.1.1	Set Easy Call to On or Off	52	15.5	Set the Answer mode	62
13.1.2	Set Easy Call number	52	15.6	Answering Machine Settings	63
13.2	Auto Conference	53	15.6.1	Ring Delay	63
13.3	Call Barring	53	15.6.2	Remote Access	63
13.3.1	Set Call Barring Mode	53	15.6.3	Handset Screening	64
13.3.2	Set a Call Barring number	53	15.6.4	Setting the Outgoing Message Language	65
13.4	XHD Sound	54	16	Technical data	65
13.5	Change PIN	54	17	Frequently asked questions	66
13.6	Registration	54	17.1	Connection	66
13.6.1	Easy registration	55	17.2	Set-up	66
13.6.2	Manual registration	55	17.3	Sound	66
13.7	Unregister	55	17.4	Product behaviour	67
13.8	Reset Unit	56	18	INDEX	69
13.9	Set Area Code	56			
13.10	Set Auto Prefix	56			
13.11	Change Flash time	57			
13.12	Change the Dial Mode	57			
13.13	Set First Ring Detection	57			
13.14	Changing the Line Setting (Handset only)	58			
13.15	Default Settings	59			
14	Network Service	59			
14.1	Voice Mail	59			
14.1.1	Access Voice Mail	60			

1 Important Safety Instructions

Some of the following information may not apply to your particular product; however, when using telephone equipment, basic safety precautions should always be followed to reduce the risk of fire, electric shock and injury to persons, including the following:

- 1 Read and understand all instructions.
- 2 Follow all warnings and instructions marked on the product.
- 3 Unplug this product from the wall outlet before cleaning. Do not use liquid cleaners or aerosol cleaners. Use a damp cloth for cleaning.
- 4 Telephones should not be used while you are in a bathtub, shower or pool. Immersion of the telephone or handset in water could cause an electrical shock.
- 5 Slots and openings in the cabinet back or bottom are provided for ventilation, to protect it from overheating. These openings must not be blocked or covered. The openings should never be blocked by placing the product on the bed, sofa, rug, or other similar surface. This product should not be placed in a built-in installation unless proper ventilation is provided.
- 6 This product should be operated only from the type of power source indicated on the marking label. If you are not sure of the type of power supply to your home, consult your dealer or local power company.
- 7 Do not allow anything to rest on the power cord. Do not locate this product where the cord will be abused by persons walking on it.
- 8 Do not overload wall outlets and extension cords as this can result in the risk of fire or electric shock.
- 9 Never push objects of any kind into this product through cabinet slots as they may touch dangerous voltage points or short out parts that could result in a risk of fire or electric shock.
Never spill liquid of any kind on the product.
- 10 To reduce the risk of electric shock, do not disassemble this product, but take it to a qualified service personnel when service or repair work is required. Opening or removing covers may expose you to dangerous voltages or other risks. Incorrect reassembly can cause electric shock when the appliance is subsequently used.
- 11 Do not expose the product to extreme temperatures such as areas near a hot radiator or stove or in a hot car.
- 12 Do not place lighted candles, cigarettes, cigars, etc., on the telephone.
- 13 Never touch uninsulated telephone wires or terminals unless the

telephone line has been disconnected at the network interface.

- 14** Never install or modify telephone wiring during a lightning storm.
- 15** Never install telephone jacks in wet locations unless the jack is specifically designed for wet locations.
- 16** Use caution when installing or modifying telephone lines to prevent electrical shock and/or fire.
- 17** Unplug this product from the wall outlet and refer servicing to qualified service personnel under the following conditions:
 - A** When the power supply cord or plug is damaged or frayed.
 - B** If the product has been exposed to rain or water.
 - C** If the product does not operate normally by following the operating instructions.
 - D** If the product's cabinet has been damaged.
 - E** If the product exhibits a distinct change in performance.
- 18** Avoid using a telephone (other than a cordless type) during an electrical storm. There may be a remote risk of electric shock from lightning.
- 19** Do not use the telephone to report a gas leak in the vicinity of the leak.
- 20** Do not place this product on an unstable cart, stand or table. The product may fall, causing serious damage to the product.

IF YOUR PRODUCT UTILIZES BATTERIES, THE FOLLOWING

ADDITIONAL PRECAUTIONS SHOULD BE OBSERVED:

- 1** Use only the type and size of battery(ies) specified in the user manual.
- 2** Do not dispose of the battery(ies) in fire. They may explode. Check with local codes for possible special disposal instructions.
- 3** Do not open or mutilate the battery(ies). Released electrolyte is corrosive and may cause damage to the eyes or skin. It may be toxic if swallowed.
- 4** Exercise care in handling battery(ies) in order not to short out the battery(ies) with conducting materials such as rings, bracelets, and keys. The battery(ies) or conductor may overheat and cause burns.
- 5** Do not attempt to recharge the battery(ies) provided with or identified for use with this product that are not intended to be charged. The battery(ies) may leak corrosive electrolyte or explode.
- 6** Do not attempt to rejuvenate the battery(ies) provided with or identified for use with this product by heating them. Sudden release of the battery(ies) electrolyte may occur causing burns or irritation to eyes or skin.
- 7** When replacing battery(ies), all batteries should be replaced at the same time. Mixing fresh and discharged batteries could increase internal cell pressure and rupture

the discharged battery(ies). (Applies to products employing more than one separately replaceable primary battery.)

- 8 When inserting battery(ies) into this product, the proper polarity or direction must be observed. Reverse insertion of battery(ies) can cause charging, and that may result in leakage or explosion.
- 9 Remove battery(ies) from this product if storing over 30 days because the battery(ies) could leak and damage the product.
- 10 Discard "dead" battery(ies) as soon as possible since "dead" batteries are more likely to leak in a product.
- 11 Do not store this product, or the battery(ies) provided with or identified for use with this product, in high temperature areas. Batteries that are stored in a freezer or refrigerator for the purpose of extending shelf life should be protected from condensation during storage and defrosting. Batteries should be stabilized at room temperature prior to use after cold storage.
- 12 If your product uses rechargeable battery(ies), charge the battery(ies) only in accordance with the instructions and limitation specified in the User Manual.

SAVE THESE INSTRUCTIONS

2 Environment and safety

2.1 Safety information

This telephone is not designed for making emergency telephone calls when the power fails. An alternative should be made available for access to emergency calling.

2.2 Power requirements

This product requires an electrical supply of 120 volts, single phase alternating current, excluding IT installations defined in standard UL 60950.

2.3 Battery requirements

The handset requires power source of two rechargeable NiMH batteries, size AAA 1.2V 600mAh (Hr11/45). IF THE INCORRECT TYPE OF BATTERIES ARE USED, A WARNING MESSAGE WILL BE DISPLAYED.

Use only Philips Multi-Life 600mAh rechargeable NiMH batteries.

For servicing or replacement, you can purchase a suitable headset through service centre or retail shop.

2.4 Telephone connection

The voltage on the network is classified as TNV- 3 (Telecommunication Network Voltages, as defined in the standard UL

60950). Following a power cut, the call in progress is lost.

Caution

Users should ensure for their own protection that the electrical ground connections of the power utility, telephone lines and internal metallic water pipe system, if present, are connected together. This precaution may be particularly important in rural areas.

2.5 Environmental care

Please remember to observe the local regulations regarding the disposal of your packaging materials, exhausted batteries and old phone and where possible promote their recycling.

2.6 Precautions

- Do not allow the handset to come into contact with liquids or moisture.
- Do not open the handset, base station or charger. This could expose you to high voltages.
- Do not allow the charging contacts of the charger or the battery to come into contact with extraneous conductive materials.
- There is a slight chance that the telephone could be damaged by an electrical storm. It is recommended that users unplug the phone from the USB socket and the phone line from the phone wall socket during a storm.
- Because the phone works by sending radio signals between the base unit and the handset, wearers of hearing

aids may experience interference in the form of a humming noise.

- We advise that this phone should not be used near intensive care medical equipment, nor by persons with pacemakers.
- Your phone can interfere with electrical equipment such as answering machines, TV and radio sets, clock radios and computers if placed too close. It is recommended that you position the base unit at least one meter from such appliances.

Caution

Use only the mains adapter supplied with this telephone. Incorrect adapter polarity or voltage can seriously damage the unit.

Base adapter:

Input: 100 V - 240 VAC 50/60 Hz

Output: 6 VDC 500 mA

Charger adapter:

Input: 100 V - 240 VAC 50/60 Hz

Output: 6 VDC 210 mA

Caution

RISK OF EXPLOSION IF BATTERY IS REPLACED BY AN INCORRECT TYPE.

Never use non-rechargeable batteries; use recommended type supplied with this telephone. NiMH batteries must be disposed of in accordance with the applicable waste disposal regulations.

FCC CERTIFICATION NUMBER IS LOCATED ON THE CABINET BOTTOM

The term "IC:" before the certification number signifies that Industry Canada technical specifications were met. This certification means that the equipment

meets certain radio communications and operational requirements.

2.7 Equipment Approval Information

Your telephone equipment is approved for connection to the public switched telephone network and is in compliance with parts 15 and 68, FCC Rules and Regulations and the Technical Requirements for Telephone Terminal Equipment published by ACTA.

2.7.1 Notification to the Local Telephone Company

On the bottom of this equipment is a label indicating, among other information, the US number and Ringer Equivalence Number (REN) for the equipment. You must, upon request, provide this information to your telephone company.

The REN is useful in determining the number of devices you may connect to your telephone line and still have all of these devices ring when your telephone number is called. In most (but not all) areas, the sum of the RENs of all devices connected to one line should not exceed 5. To be certain of the number of devices you may connect to your line as determined by the REN, you should contact your local telephone company. A plug and jack used to connect this equipment to the premises wiring and telephone network must comply with the

applicable FCC Part 68 rules and requirements adopted by the ACTA. A compliant telephone cord and modular plug is provided with this product. It is designed to be connected to a compatible modular jack that is also compliant. See installation instructions for details.

Notes

- This equipment may not be used on coin service provided by the telephone company.
- Party lines are subject to state tariffs, and therefore, you may not be able to use your own telephone equipment if you are on a party line. Check with your local telephone company.
- Notice must be given to the telephone company upon permanent disconnection of your telephone from your line.
- If your home has specially wired alarm equipment connected to the telephone line, ensure the installation of this product does not disable your alarm equipment. If you have questions about what will disable alarm equipment, consult your telephone company or a qualified installer.

2.7.2 Rights of the Phone Company

Should your equipment cause trouble on your line which may harm the telephone network, the telephone company shall, where practicable, notify you that

temporary discontinuance of service may be required. Where prior notice is not practicable and the circumstances warrant such action, the telephone company may temporarily discontinue service immediately. In case of such temporary discontinuance, the telephone company must:

(1) promptly notify you of such temporary discontinuance; (2) afford you the opportunity to correct the situation; and (3) inform you of your right to bring a complaint to the Commission pursuant to procedures set forth in Subpart E of Part 68, FCC Rules and Regulations. The telephone company may make changes in its communications facilities, equipment, operations or procedures where such action is required in the operation of its business and not inconsistent with FCC rules and Regulations. If these changes are expected to affect the use or performance of your telephone equipment, the telephone company must give you adequate notice, in writing, to allow you to maintain uninterrupted service.

2.8 Interference Information

This device complies with Part 15 of the FCC Rules. Operation is subject to the following two conditions:

(1) this device may not cause harmful interference; and (2) this device must accept any interference received, including interference that may cause undesired operation.

This equipment has been tested and found to comply with the limits for a Class B digital device, pursuant to Part 15 of the FCC Rules.

These limits are designed to provide reasonable protection against harmful interference in a residential installation. This equipment generates, uses, and can radiate radio frequency energy and, if not installed and used in accordance with the instructions, may cause harmful interference to radio communications. However, there is no guarantee that interference will not occur in a particular installation.

If this equipment does cause harmful interference to radio or television reception, which can be determined by turning the equipment off and on, the user is encouraged to try to correct the interference by one or more of the following measures:

- Reorient or relocate the receiving antenna (that is, the antenna for radio or television that is “receiving” the interference).
- Reorient or relocate and increase the separation between the telecommunications equipment and receiving antenna.
- Connect the telecommunications equipment into an outlet on a circuit different from that to which the receiving antenna is connected.

If these measures do not eliminate the interference, please consult your dealer or an experienced radio / television technician for additional suggestions. Also, the Federal Communications

Commission has prepared a helpful booklet, "How To Identify and Resolve Radio/TV Interference Problems". This booklet is available from the U.S.

Government Printing Office,
Washington, D.C. 20402.

Please specify stock number 004-000-00345-4 when ordering copies.

Notice: The changes or modifications not expressly approved by the party responsible for compliance could void the user's authority to operate the equipment.

2.9 Hearing Aid Compatibility (HAC)

This telephone system meets FCC and Industry Canada standards for Hearing Aid Compatibility.

2.10 FCC RF Radiation Exposure Statement

This equipment complies with FCC RF radiation exposure limits set forth for an uncontrolled environment. This equipment should be installed and operated with a minimum distance of 20 centimeters between the radiator and your body. This transmitter must not be co-located or operating in conjunction with any other antenna or transmitter. For hand held operation, this phone has been tested and meets the FCC RF exposure guidelines. Use of other accessories may not ensure compliance with FCC RF exposure guidelines.

3 Important

Take time to read this user manual before you use your phone. It contains important information and notes regarding your phone.

NOTICE: This product meets the applicable Industry Canada technical specifications.

The equipment must be installed using an acceptable method of connection. The customer should be aware that compliance with the above conditions may not prevent degradation of service in some situations.

Repairs to certified equipment should be made by an authorized Canadian maintenance facility designated by the supplier. Any repairs or alterations made by the user to this equipment, or equipment malfunctions, may give the telecommunications company cause to request the user to disconnect the equipment.

Users should ensure for their own protection that the electrical ground connections of the power utility, telephone lines and internal metallic water pipe systems, if present, are connected together. This precaution may be particularly important in rural areas. **CAUTION:** Users should not attempt to make such connections themselves, but should contact the appropriate electric inspection authority, or electrician, as appropriate.

NOTES: This equipment may not be used on coin service provided by the telephone company.

3.1 Power requirements

- This product requires an electrical supply of 100-240 volts AC. In case of power failure, the communication can be lost.
- The Electrical network is classified as hazardous. The only way to power down the charger is to unplug the power supply from the electrical outlet. Ensure that the electrical outlet is always easily accessible.
- The voltage on the network is classified as TNV-3 (Telecommunication Network Voltages), as defined in the standard UL 60950.

Warning

To avoid damage or malfunction:

- Do not allow the charging contacts or the battery to come into contact with metal objects.
- Do not open it as you could be exposed to high voltages.
- Do not allow the charger to come into contact with liquids.
- Never use any other battery than the one delivered with the product or recommended by Philips: risk of explosion.
- Always use the cables provided with the product.
- Handsfree activation could suddenly increase the volume in the earpiece to

a very high level: make sure the handset is not too close to your ear.

- This equipment is not designed to make emergency calls when the power fails. An alternative has to be made available to allow emergency calls.
- Do not expose the phone to excessive heat caused by heating equipment or direct sunlight.
- Do not drop your phone or allow objects to fall on your phone.
- Do not use any cleaning agents containing alcohol, ammonia, benzene, or abrasives as these may harm the set.
- Do not use the product in places where there are explosive hazards.
- Do not let small metal objects come into contact with the product. This can deteriorate audio quality and damage the product.
- Active mobile phones in the vicinity may cause interference.

About operating and storage temperatures:

- Operate in a place where temperature is always between 0 and 35° C (32 to 95° F).
- Store in a place where temperature is always between -20 and 70° C (-4 to 158° F).
- Battery life may be shortened in low temperature conditions.

3.2 Electric, Magnetic and Electromagnetic Fields (“EMF”)

1. Philips Royal Electronics manufactures and sells many consumer oriented products which usually, as with any electronic apparatus, have the ability to emit and receive electro magnetic signals.
2. One of Philips’ leading Business Principles is to take all necessary health and safety precautions for our products, to comply with all applicable legal requirements and to stay well within the EMF standards applicable at the time of producing the products.
3. Philips is committed to develop, produce and market products that cause no adverse health effects.
4. Philips confirms that if its products are handled properly for their intended use, they are safe to use according to scientific evidence available today.
5. Philips plays an active role in the development of international EMF and safety standards, enabling Philips to anticipate further developments in standardisation for early integration in its products.

3.3 Recycle your batteries

Do not dispose your rechargeable batteries. Call the toll free number 1-800-822-8837 to get instructions on how to recycle your batteries.

4 The RBRC[®] seal



The RBRC[®] Seal on the nickel metal hydride battery indicates that Philips Royal Electronics is voluntarily

participating in an industry program to collect and recycle these batteries at the end of their useful lives, when taken out of service within the United States and Canada.

The RBRC[®] program provides a convenient alternative to placing used nickel metal hydride batteries into the trash or municipal waste, which may be illegal in your area.

Philips’s participation in RBRC[®] makes it easy for you to drop off the spent battery at local retailers participating in the RBRC[®] program or at authorized Philips product service centers.

Please call 1-800-8-BATTERY for information on Ni-MH battery recycling and disposal bans/restrictions in your area. Philips’s involvement in this program is part of its commitment to protecting our environment and conserving natural resources.

RBRC[®] is a registered trademark of Rechargeable Battery Recycling Corporation.

4.1 Service Centers

US service center

Philips Accessories & Computer

Peripherals North America 1881 Route

46 WestLedgeWood, NJ 07852

Phone: (800) 233-8413

E-mail support:

<http://www.support.philips.com/support>

5 Your phone

Congratulations on your purchase and welcome to Philips!

To fully benefit from the support that Philips offers, register your product at www.philips.com/welcome.

5.1 What's in the box



Handset with belt clip

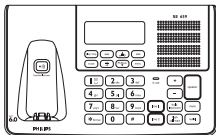

Base Station



Battery door

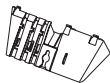

Bracket for wall mounting



2 AAA rechargeable batteries

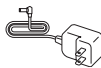

Power supply

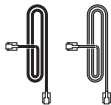

Line cords*



User manual



Guarantee



Do not return leaflet



Quick Start Guide

Note

* The black line cord is a 4-pin telephone line cord, * and the gray line cord is a 2-pin telephone line cord. Use these as explained in 7.1 Connect the base station. In multihandset packs, you will find one or more additional handsets, chargers with power supply units and additional rechargeable batteries.

5.2 Overview of your handset

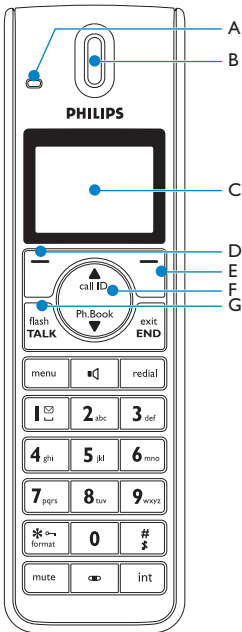

A Event LED

The event LED on your handset blinks when there is a new message recorded on your telephone answering machine. If you have subscribed to Caller Line Identification, the event LED also blinks when there is a new call, or a new voice mail message.

B Earpiece

C Display

See section 5.3 for an overview of the display icons.

D Select key

Press to receive an incoming call on Line 1, or to select Line 1 for making an outgoing call.

In a menu, selects the function displayed on the screen or go to the next lower level. Also used to confirm entries (for example, when setting date and time).



E Back/Clear key

Press to receive an incoming call on Line 2, or to select Line 2 for making an outgoing call.



When making an entry, press to clear (delete) a character or number, or long press to clear all.



When navigating menus, press to move to the previous higher menu level (**Back** is displayed).

F Navigation keys

In idle mode: Scroll up  call ID to access the Call log and scroll down  Ph.Book to access the Phonebook.

During a call: Scroll  to increase or decrease earpiece and speaker volume.

Editing and entry: Move to the previous character  call ID or next character  Ph.Book.

In other modes: Scroll up  call ID and down  Ph.Book a menu list or go to the previous or next record in the Phonebook, Redial list, or Call log.

G Talk key

In idle mode: Make or answer an external call on the default line, or answer an incoming internal call.

During a call: Activate the flash function.

In other modes: Dial the selected number in the Phonebook, Redial list, or Call log on the default line.

H Hang-up/Exit key

In idle mode: Long press (5 seconds) to switch off the handset.

When the handset is switched off: Long press (1 second) to switch it on.

During a call: Hang up a call.

In other modes: Press to return to idle mode.

I Menu key

In idle mode: Go to the main menu.

J Redial key



Access the Redial list in idle mode.

K Loudspeaker key

In idle mode: Turn on the loudspeaker and dial the number. Answer an incoming call on the default line using handsfree mode.

During a call: Toggle the loudspeaker on/off.

L Number keys

Use to dial numbers and write characters. With key , a long press invites you to select a line, then dials your voice mail subscriber access number via the selected line. With keys  to , a long press invites you to select a line, then dials one of your direct memory access numbers via the selected line.

M */Keypad lock & Format key

In idle mode: Long press to lock/ unlock keypad.

Redialling or editing: Press to enter a “*”.

Off hook: Long press to temporarily switch to tone (DTMF) dialling if using pulse.

During call log display: Toggles area code and long distance display on/off.

N #/Ringer on/off & Pause key

In idle mode: Long press to turn the ringer on/off.

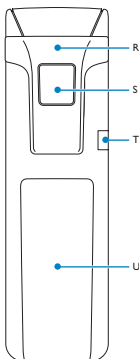
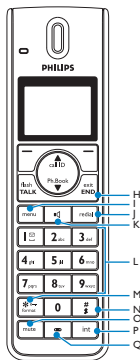

Dialling or editing: Long press to insert a pause (during pre-dialling) and short press to insert a “#”.

Editing: Short press to switch upper/ lower case.

O Mute key

When off hook: Deactivate/activate the microphone.

P Call transfer key & Intercom key

In idle mode: Initiate an internal call.

During a call: Short press to hold the line and page another handset. Long press to set up a conference between an external call and two handsets.

Q Microphone

R Belt clip

S Loudspeaker (underneath the belt clip)

Warning

Handsfree activation can suddenly increase the volume of the earpiece to a

very high level. Make sure the handset is not too close to your ear.

T Headset jack

U Battery door

5.3 Display icons and Messages



Indicates that the battery is fully charged. This icon blinks during charge and when the battery is low.



When the icon is empty the battery is practically discharged.

Note

If **Warning Batt** flashes together with a blinking battery icon, batteries of the wrong type are installed in the handset. Replace with batteries of the correct type.



Blinks when there is an incoming call. Steady On during a call.



If you subscribe to voice mail service, blinks when there is new voice mail.



Blinks when there are new and missed calls in the call log records.



Appears when the alarm clock is activated. Blinks when the alarm time comes.



Appears when the loudspeaker is activated.



Appears when the ringer is off.



Steady on when the answering machine is on. Blinks when messages have been received by the answering machine; blinks rapidly when answering machine memory is full.



Indicates that the handset is registered and within range of the base station. Icon blinks when the handset is out of range or is searching for a base. Appears when using Line 1.



Appears when using Line 2.



L1 IN USE

Steady ON when another unit is using Line 1 (appears only in talk mode).

L1 HOLD

Steady on when Line 1 is on hold (appears only in talk mode).

L1 CALL

Steady on when there is a incoming call on Line 1 (appears only in talk mode).

L2 IN USE

Steady ON when another unit is using Line 2 (appears only in talk mode).

L2 HOLD

Steady on when Line 2 is on hold (appears only in talk mode).

L2 CALL

Steady on when there is a incoming call on Line 2 (appears only in talk mode).

Line 1/Select/OK

Line 1 selects Line 1.

Select appears when in menu mode. Press the key directly below to move to the next menu level or to confirm a selection.

OK appears to request confirmation of an operation. Press the key directly below to confirm.



Indicates that more options are available in a scroll list, or that you can adjust the volume.

Line 2/Back/Clear

Line 2 selects Line 2.

Back appears when in menu mode. Press the key directly below to return to the previous menu level.

Clear appears when making an entry. Press the key directly below to clear (delete) a character or number when making an entry. Long press to clear all.

5.4 Overview of the base station

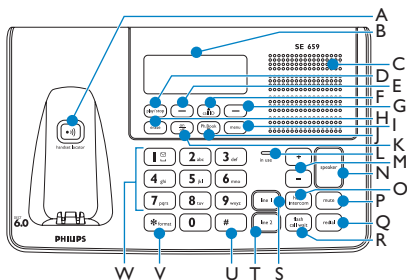

A Handset locator key

Locate handset.

Long press more than 3 seconds to start the registration procedure.

B Display

See 5.5 for an overview of the display.

C Speaker

D Play/Stop key

Play phone messages (the first message recorded will be played first). After pressing this key, select Line 1 or Line 2 using the soft keys. Voice prompts are played between messages and when all messages have been played.

Stop message playback.

E Previous/Select Key

During message playback: Go to the previous message.

In menu mode: Select the function displayed on the screen or go to the next lower level in a menu.

F Call log/Up key

In idle mode: Enter the call log.

In menu mode: Scroll up in the list.

G Back/Clear Key

During message playback: Go to the next message.

In menu mode: Go to the previous level in a menu.

H Erase Key

During message playback: Short press to delete the current message.

In idle mode: Long press to delete all old messages. After long pressing this key, select Line 1 or Line 2 using the soft keys.

I Menu key

Enter/exit the main menu.

J Phonebook/Down key

In idle mode: Enter the phonebook.

In menu mode: Scroll down in the list.

K On/Off Key

Short press to switch the answering machine on/off. After pressing this key, select Line 1 or Line 2 using the soft keys.

L Event LED

The event LED on the base blinks during handset locating. It is steady on when a handset has taken the line.

M Volume Keys

In idle mode: Increase or decrease the ring volume. Ring volume can be set separately for each of Line 1 and Line 2. During a conversation or during message playback: Increase or decrease the speaker volume.

N Speaker key

In idle mode: Pick up the first open line with the speaker on.

During a call: End the call. The speaker key LED blinks when receiving an incoming call. It is steady on when the base is in talk mode.

O Hold/Intercom key

In idle mode: Initiate an internal call. During a call: End the call. The speaker key LED blinks when receiving an incoming call. It is steady on when the base is in talk mode.

P Mute key

When off hook: Mute/Unmute the microphone.

Q Redial key

Access the Redial list.

R Flash/Call waiting

Send a flash on the line. If there is an incoming call waiting, answer the call.

S Line 1 key

In idle mode: Pick up Line 1 with the speaker on.

During a call: Release Line 1. If there is a current call on Line 2, pick up Line 1 and put the call on hold on Line 2.

T Line 2 key

In idle mode: Pick up Line 2 with the speaker on.

During a call: Release Line 2. If there is a current call on Line 1, pick up Line 2 and put the call on hold on Line 1.

U Hash key

Short press to enter a '#'.

Long press to enter a pause.

V Star/format key

Enter a '**'.
When viewing the call log, press to

change the number format. (See section 11.1.1 - "To choose the format for call log display.")

W Number keys

Short press to dial numbers.

Long press keys  to  to dial a direct access memory number.

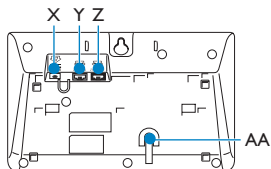

X DC IN 6V jack

Y TEL LINE 2 phone jack

Z TEL LINE 1/2 phone jack

AA Microphone (at the bottom front of the base station)

5.5 Base station display

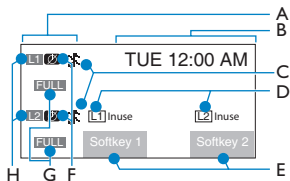

A Sub-screen display area

Shows answering machine status. See below.

B Main display area

In idle mode: Displays the time and date or new events.

In menu mode: Displays the options in the menu.

C Ringer Off Icon

Turns on when the ringer volume is set to zero. The small numerals "1" and "2" show which line(s) have ringer volume set to zero.

D L1 and L2 in Main Display Area

L1 is for Line 1 and L2 is for Line 2. These icons blink when the line is receiving a call.

They are steady on when:

- The line is off-hook.
- The line is in external talk mode.
- Viewing call log of the line.
- The line is in hold mode or in use by handset.
- The line is set to Call barring on.

E Soft keys

Soft key 1 is activated by the **Select/OK** key. Soft key 2 is activated by the **Back/Clear** key.

F Answering Machine Counters

Displays  steady on when the answering machine of the line is set to off.

Displays "AA" steady on when the answering machine of the line is in handset remote control mode or auto answering mode.

G Message Counter

Shows the number of the messages in answering machine for the line. Blinks when there are new messages.

The **FULL** icon comes on when message memory of the line is full, but only when there are no new messages.

H L1 and L2 in the Sub-screen Display Area

L1 is for Line 1 and L2 is for Line 2. These icons appear at all times.

6 Conventions Used in this Manual

This manual uses the following conventions.

• **Bold text**















Bold text is used for messages and instructions that are shown on the handset or base display screen.

• **Handset and Base Station Keys**

Except where indicated otherwise, basic operation is the same for both the handset and base station of this product. However, for some functions the keys

used on the handset and base station have different shapes or different lettering.

The procedures in this manual use the handset key icons. This table shows the corresponding keys for the base station. Refer to it when needed.

Key on Handset	Key on Base Station
 call ID  Ph.Book	 call ID  Ph.Book
	Left  key
	Right  key
 int	 hold intercom
 * format	 * format
 #	 #





These keys are used to access the main menu and utilize functions such as redial and caller ID.

For details, see 5.2 and 5.4.

• Terminology

When a procedure applies equally to the handset and the base station, the word “unit” is used to indicate both.

• Scrolling

“Scroll ” means to use the  call ID and  Ph.Book keys on the handset or the  call ID and  Ph.Book keys on the base station to scroll through a menu or list on the display screen.

Note: See Section 5 for detailed descriptions of the functions and use of the keys of the handset and base station.

7 Getting started

7.1 Connect the base station

- 1 Place the base station in a central location near the telephone line socket and electricity socket.
- 2 Connect the line cord(s) and the power cable to their corresponding connectors at the back of the base station.

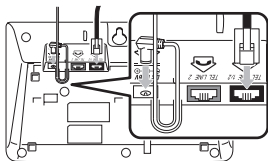

Note

For 2 line subscriptions, connect the 4-pin telephone line cord (the black cord) to the black TEL LINE 1/2 phone jack and to the telephone wall jack for line 1.

Connect the second telephone line cord (the gray cord) to the gray TEL LINE 2 phone jack and to the telephone wall jack for line 2.

If the two phone lines are on one modular wall jack, connect only the 4-pin telephone line cord (the black cord) to the black TEL LINE 1/2 phone jack and to the telephone wall jack. (Do not connect anything to the gray TEL LINE 2 phone jack.)

- 3 Connect the other end of each of the line cords to its socket.

- 4 Connect the power cable to the power outlet.

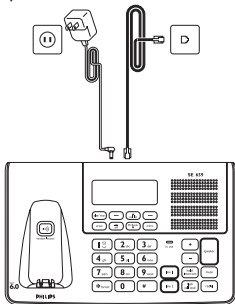

Note

Line adaptors may not be attached to the line cords. In this case, you have to connect line adaptors to the line cords first before plugging the line cords into the line sockets.

Warning

Avoid placing the base station too close to large metal objects such as filing cabinets, radiators or electrical appliances. This can impair the range and sound quality. Buildings with thick internal and external walls may impair transmission of signals to and from the base.

Warning

Power is applied when the power adaptor is plugged into the unit and connected to the electricity socket. The only way to power down the unit is to unplug the power adaptor from the electricity socket. Therefore, ensure that the electricity socket is easily accessible.

The power adaptor and telephone line cord(s) have to be connected correctly, as incorrect connection could damage the unit. Always use the telephone line cord(s) supplied with the unit. Otherwise, you may not get a dial tone.

7.2 Wall mounting the base

The base is designed to support wall mounting. To wall mount the base, follow the instructions below.

- 1 Attach the bracket to the base station as shown below.

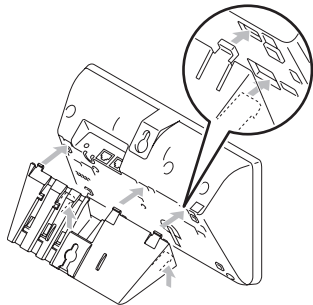

- 2 Use the pedestal wall mounting to plug your base station.

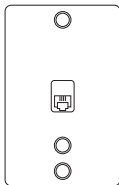

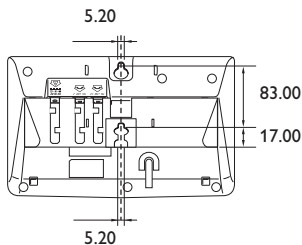

7.3 Install your phone

Before using the handset, the batteries have to be installed and fully charged.

Warning

When the batteries are inserted for the first time, the unit will not be able to start normally due to the low battery. You must charge the batteries on the base station before you can use the handset.

7.3.1 Install battery

Warning

Always use AAA rechargeable batteries supplied with your unit. If alkaline batteries are used instead of rechargeable batteries, “**Warning Batt**” will show on the display and the battery icon will blink quickly.

- 1 Slide out the battery cover.

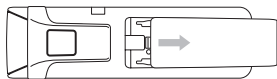

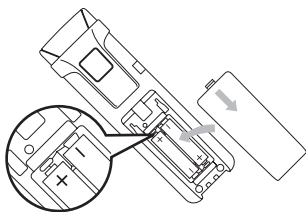

- 2 Place the batteries in the correct polarity as indicated and replace the cover.



7.3.2 Charge battery

Warning

The handset must be charged for at least 24 hours before using it for the first time. When the battery level becomes low, the low battery sensor warns you by blinking the battery icon. If this occurs during a conversation, an alert tone sounds to inform you that the battery is low. If the battery level becomes exceedingly low, the phone automatically switches off shortly after the icon starts blinking and any function in progress will not be saved.

- 1 Place the handset on the charging cradle of the base station. A beep is emitted if the handset is placed correctly.
- 2 The battery icon  on the display blinks during charge.
- 3 The battery icon  becomes steady when the handset is fully charged.

Note

Optimal battery life is reached after 3 cycles of complete charging (over 15

hours) and discharging, allowing approximately 12 hours of talk-time and 150 hours of stand-by time.

The indoor and outdoor range of the phone is up to 50 metres and 300 metres respectively. When the handset moves beyond the operation range, the antenna icon  will blink.

*** Tip**

When you reach the range limit the conversation may become crackly. Move closer to the base.

7.4 Remove/Attach belt clip

A belt clip allows you to carry your handset on your belt.

- 1 To remove the belt clip, simply pull the clip away from the handset.
- 2 To attach the belt clip to your handset, fit the tabs on the belt clip into the slots at the back of the handset and push into place.

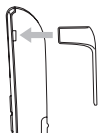

7.5 Install optional headset

Your phone may be used with an optional headset (not included in the box). To use this feature, insert the headset plug into the headset jack. Your phone is ready for hands-free conversations.

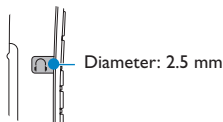

7.6 Power up

On the base, the screen below is shown during power up.

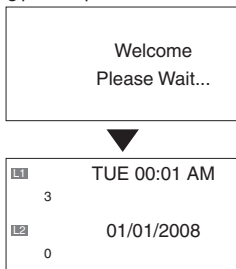

The handset will start searching and the backlight will turn on.

Handset screen

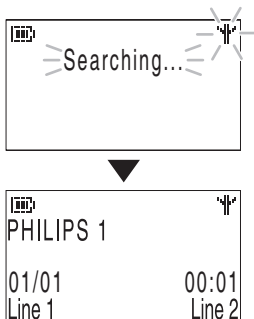

The display will show the word “Searching” and Antenna icon flashing until it locks onto its subscribed base. Then the display shows the standby display.







7.7 Using multipacks



If you have purchased a multipack you will have additional handsets, chargers, power adaptors and AAA rechargeable batteries.



- 1** Plug the chargers into a power socket.
- 2** Install the batteries supplied into the handsets.
- 3** Place the handsets on the chargers to charge the batteries.

7.8 Handset menu structure

The SE659 has six menus as shown in the following table.

	Menu Name	Icon
1	Phonebook	
2	Personal Settings	
3	Clock and Alarm	
4	Advanced Settings	
5	Network Services	
6	Answer Machine	

Press the menu key  to enter menu mode. Use navigation keys  to navigate within the menus and all submenus.

Press  **Select** to enter the next lower menu level. Press  **Back** to go to the previous menu level.

The charts below show the menu trees of your phone.

Phonebook

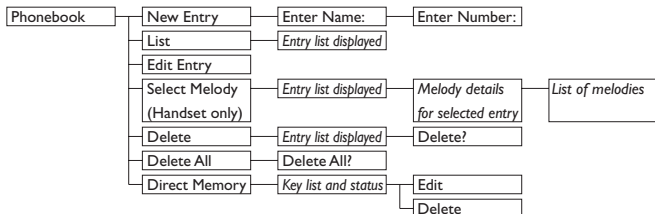

Personal Settings

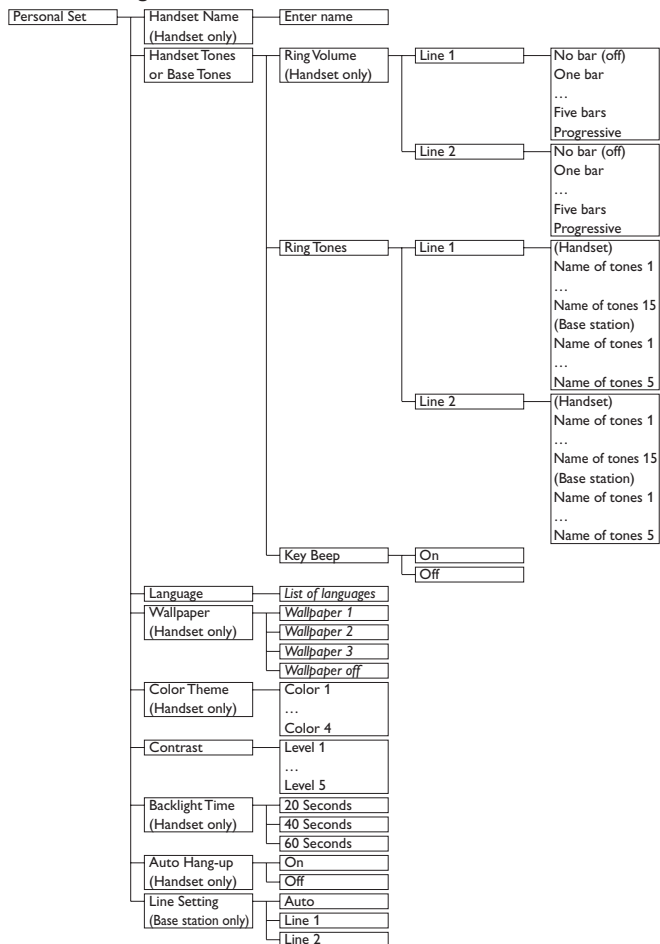

Clock and Alarm

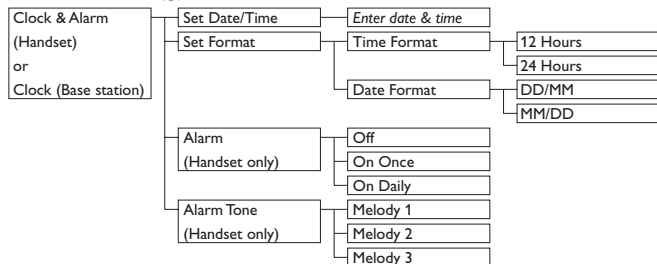

Advanced Settings (Handset only)

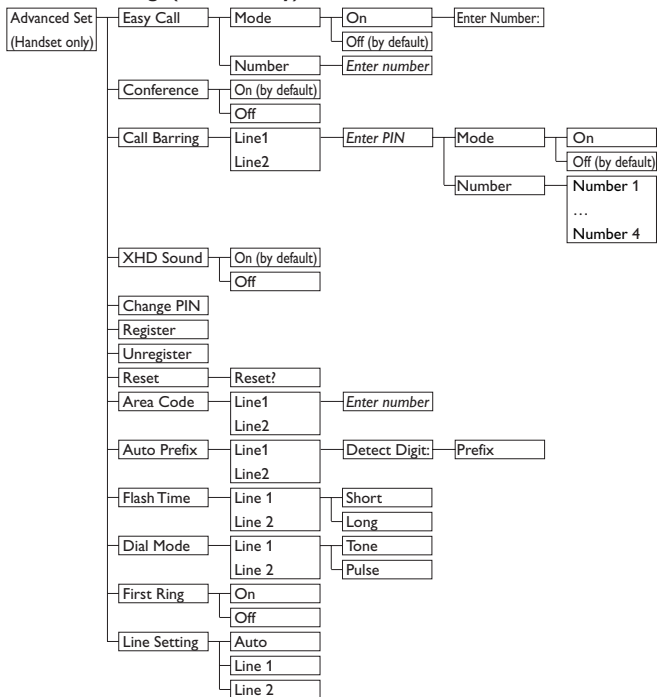

Network Services (Handset only)

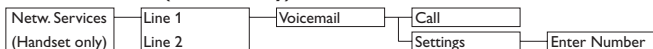

Answer Machine

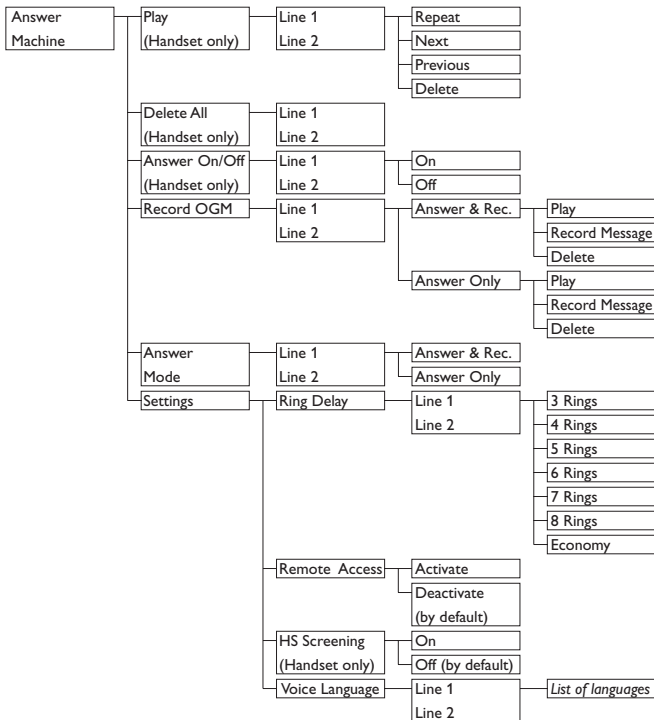





8 Using your phone

8.1 Make a call



8.1.1 Predialling

1 Enter the number. (A maximum of 24 digits including * and # are allowed. Press  **Clear** to delete the last digit. Or long press to delete all.)

2 From the handset: Press . The line selection menu appears and the default line is highlighted. If you want to switch to the other line, scroll . To start the call, press  or  **Select** (or press  to start in speaker mode).

- The call is initiated on the highlighted line.

From the base: Press  to call from the default line. When **Auto** is selected as the line setting, the base will automatically select a free line.



To call from a particular line, press  or .

- The call is initiated.



Note

For the line setting on the base station, see section 12.9.

8.1.2 Direct dialling

1 From the handset: Pick up the handset. To call from the default line, press  (or press  to start a call in speaker mode). To call from a



particular line, press  **Line 1** or  **Line 2**.

From the base: Press  to call from the default line. To call from a particular line, press  or .

2 Dial the number.

- The call is initiated.





Note

If **Auto** is selected as the line setting, the phone will automatically select a free line when you press  or  on the handset or  on the base. For the line setting, see section 13.14 for the handset and section 12.9 for the base station.

8.1.3 Call from redial list



1 Press  in idle mode.

2 Scroll  to an entry in the redial list.

3 From the handset: Press . The line selection menu appears and the default line is highlighted. If you want to switch to the other line, scroll . To start the call, press  or  **Select** (or press  to start in speaker mode).

- The call is initiated on the highlighted line.

From the base: Press  to call from the default line. When **Auto** is selected as the line setting, the base will automatically select a free line.

To call from a particular line, press  or .

- The call is initiated.

Note

The handset(s) and base station each have their own redial list.

8.1.4 Call from the call log

Note





- The call log is shared between handset(s) and the base station.
- You need to subscribe to Caller Line Identification service to be able to see the caller's number or name in the call log. See section 11.1 - "Access the Call log".

1 Press  in idle mode.

Note



If the list is already empty, then "List Empty" is displayed.

2 Scroll  to an entry in the call list.

3 From the handset: Press . The line selection menu appears and the default line is highlighted. If you want to switch to the other line, scroll . To start the call, press  or  **Select** (or press  to start in speaker mode).

- The call is initiated on the highlighted line.

From the base: Press  to call from the default line. When **Auto** is selected as the line setting, the base will automatically select a free line.

To call from a particular line, press  or .

- The call is initiated.





Note

For the line setting on the base station, see section 12.9.

8.1.5 Call from the phonebook



1 Press  in idle mode.

2 Scroll  to a phonebook entry.

3 From the handset: Press . The line selection menu appears and the default line is highlighted. If you want to switch to the other line, scroll . To start the call, press  or  **Select** (or press  to start in speaker mode).

- The call is initiated on the highlighted line.

From the base: Press  to call from the default line. When **Auto** is selected as the line setting, the base will automatically select a free line.

To call from a particular line, press  or .

- The call is initiated.





Note



For the line setting on the base station, see section 12.9.

8.1.6 Call from the phonebook while already on the phone



1 While on the phone, press **Option** soft key and then  **Select** to enter the phonebook name list.

2 Scroll  to a phonebook entry.

3 From the handset: To call from the default line, press  (or press  to start a call in speaker mode). To call from a particular line, press  **Line 1** or  **Line 2**.



From the base: Press  to call from the default line. To call from a particular line, press  or .

Note

If **Auto** is selected as the line setting, the phone will automatically select a free line when you press  or  on the handset

or  on the base. For the line setting, see section 13.14 for the handset and section 12.9 for the base station.

8.1.7 Call using Direct Access Memory

Press a number key  to  for more than 2 seconds. This invites you to select a line, then dials a stored direct access memory number on the desired line.

Note

- The handset(s) and base station each have their own direct access memories.
- See section 10.7 for instructions on how to store, edit, and delete direct access memory numbers.



8.1.8 Enter a Dialing Pause

Long press key  to enter a pause in the dialing sequence. The pause is indicated by a P.

8.2 Answer a call

Danger





When the handset rings during an incoming call, please do not hold the handset too close to your ear as the volume of the ringing tone may damage your hearing.

When the phone rings, the L1 (or L2) indicator and **L1 CALL** (or **L2 CALL**) icon appear to indicate the incoming call line. To answer, press the appropriate soft key on the handset ( **Line 1** or 

Line 2), or /  on the base station.)

- The call is established.

Note

- When **Auto** is selected as the line setting, you can accept incoming calls on either line by pressing  or  on the handset, or  on the base station. When Line 1 or Line 2 is selected as the line setting, you can use these keys to accept calls on the selected line, but you must use the **Line 1** or **Line 2** soft keys on the handset or /  on the base station to accept calls on the other line.
- Incoming call has priority over other events. Whenever there is an incoming call, other status in progress such as phone setting, menu navigation, etc will be aborted.

8.2.1 Handsfree answering with handset

Danger

Handsfree activation can suddenly increase the volume in the earpiece to a very high level. Make sure the handset is not too close to your ear.

When the phone rings, and current default line is the incoming call line, press  on the handset.



- The loudspeaker is activated on the handset.

8.3 Answer a call on the other line

You can put the current call on hold and accept an incoming call on the other line.

- 1 When there is a incoming call from the other line, the earpiece will emit a beep tone to inform you; press the other line key on the handset.
 - The call is established on the second line.
- 2 To switch back to the first caller, either hang up the second line, or place it on hold and press the first line key to resume talking with the first caller.

8.4 End a call

To end a conversation, press  on the handset or  key on the base.

- The call ends.

Tip

When auto hang-up is on, you can simply place the handset back to its base station or charger to end the call. This feature is activated by default.



Note

The call duration (MM:SS) will be displayed on the handset screen for about 5 seconds.

8.5 Using the Redial list

The redial list stores the last 10 numbers dialed. A maximum of 32 digits can be displayed for each entry.







8.5.1 Access Redial list

- 1 Press  to go to the redial list and scroll  to browse the redial list.
 - The last number dialed will appear first in the redial list. If the redial number matches a phonebook entry, the name will be displayed instead.
- 2 To open the redial list options, press  **Menu**.





Note

Press  **Back** to return to the previous menu.

8.5.2 View redial number details

- 1 Press  in idle mode, scroll  to select an entry and press  **Menu**.
- 2 **View** is highlighted on the screen; press  **Select** to display information about the number dialed.
- 3 Press  **Next** to display further information. Afterward, you can press  **Prev.** to return to the former screen. After viewing, press  **Back** to return to previous menu levels.

8.5.3 Save a redial number into the phonebook

- 1 Press  in idle mode, scroll  to select an entry and press  **Menu**.
- 2 **View** is highlighted on the screen. Scroll  to **Save Number** and press  **Select**.

- 3 Enter Name** is displayed. Enter the name of the contact (maximum 14 characters) and press **OK**.
- 4 Enter Number** is displayed and the selected number from the redial list appears in the number field. At this time you can edit the number if you wish to.
- 5** Press **OK**. The screen returns to the redial list.

Note

Press **Clear** to delete the last digit or character entered. Long press **Clear** to clear the entire entry.

8.5.4 Delete a redial number

- 1** Press in idle mode, scroll to select an entry and press **Menu**.
- 2** Scroll to **Delete** and press **Select**.
- 3** **Delete?** is displayed on the screen.
- 4** Press **OK** to confirm deletion.
 - A validation tone is emitted.

Note

Press **Back** to discard the deletion. The screen returns to the redial list.

8.5.5 Delete all redial numbers

- 1** Press in idle mode, and press **Menu**.
- 2** Scroll to **Delete All** and press **Select**.
- 3** **Delete All?** is displayed on the screen.
- 4** Press **OK** to confirm deletion.
 - A validation tone is emitted.

9 Use more of your phone

9.1 Switch the handset off/on

To switch the handset off, press and hold  in idle mode for at least 5 seconds.





To switch it on, press and hold  for at least one second.

9.2 Handset keypad lock/unlock







Press and hold  for 3 seconds to lock/unlock the keypad in idle mode.





9.3 Text or number entry

When you select a field in which you can enter text, you can enter the letters that are printed on the keys by pressing the relevant key once or several times. For example, to enter the name “PAUL”:



- 1 Press  once: P
- 2 Press  once: PA
- 3 Press  twice: PAU
- 4 Press  three times: PAUL

The table below gives you the character assignment during text or number entry:

Keys	Assigned characters
	. 0 , / ; “ ‘ ! ; ? ; * + - % \ ^ ~
	SPACE 1 @ _ # = < > () & € £ \$ ¥ [] { } ¢ § ...
	a b c 2 à â ã ä å Æ Ç
	d e f 3 è é ê ë Æ Φ
	g h i 4 ħ ï ï ï Γ
	j k l 5 Λ

Keys	Assigned characters
	m n o 6 ñ ó ô õ ö ò
	p q r s 7 ß § Π Θ Σ
	t u v 8 ù ú û μ
	w x y z 9 ø Ω Ψ





* Tip

- Press  **Clear** to delete the last digit or character entered or long press to delete all.
- Short press  to shift between lowercase and uppercase.
- Long press  to insert a pause.

9.4 Call waiting

If you have subscribed to Call Waiting services, the earpiece will emit a beep tone to inform you that there is a second incoming call on the line you are currently using. The number or name of the second caller will also be displayed if you have subscribed to Caller Line Identification service (CLI). Please contact your network provider for more information on this service.

To hold the call in progress and answer the new call:

- From the handset, press  **Accept** or .
- From the base station, press  **Accept** or .

9.5 Call in progress

Some options are available to you during a call. The available options are :

9.5.1 Adjust earpiece or speaker volume

9.5.1.1 Earpiece or Speaker volume in handset

During a call, press  and  to select the volume level.

- The earpiece/speaker volume will be displayed as volume bar (level 1 to 5). The selected volume is saved for the next call.



9.5.1.2 Speaker volume in base

During a call, press  and  to select the volume level.

- The speaker volume will be displayed as volume bar (level 1 to 5). The selected volume is saved for the next call.

9.5.2 Mute/Unmute microphone



When the microphone is muted, your correspondent cannot hear you.

- 1 During a call, press  to turn off the microphone.
- 2 Press  again to turn on the microphone.

9.5.3 Activate/Deactivate handset loudspeaker mode







Danger

Handsfree activation can suddenly increase the volume in the earpiece to a very high level. Make sure the handset is not too close to your ear.

- 1 During a call, press  on the handset to activate the loudspeaker mode.
- 2 Press  again to return to deactivate the loudspeaker mode.

9.6 Chain dialing

This feature allows you to dial an extension to a number already saved in the phonebook during a call.

- 1 Press  or  on the handset, or press  on the base to take the default line. Then press **Option** soft key and  **Select** to enter the phonebook list.
- 2 Scroll  to a phonebook entry.
- 3 Press  **Select**.
 - The first part is dialed.
- 4 Enter the extension.

9.7 Using the Intercom



The intercom feature allows you to make free internal calls, transfer external calls from one unit to another and use the conference option.

9.7.1 Intercom another unit



Note

If the handset does not belong to this model's series, this function may not be available.

- 1 Press  in idle mode.
 - Intercom between the base and the handset is established immediately if there is only one handset registered to the base.



2 If there is more than 1 registered handset, scroll  to select the unit to call and press  **Select**.

- Once the intercom call is initiated the  icon is displayed on the handset.

3 Press  to answer an intercom call on the called handset, or  to answer on the base.

- The intercom is established.



Note

Pressing  on any handset or  on the base will exit intercom mode and return other units to idle mode. If an external call arrives during intercom mode and you want to accept this call, you must first exit intercom mode.

9.7.2 Transfer an external call to another unit

1 During the call, press  to put the external call on hold (the caller can no longer hear you).

- The display shows the numbers of the handsets registered to the base and the base as well if you are looking at the display on a handset.

2 Scroll  to the unit you wish to transfer your external call to and press  **Select**.

3 Press  on the called unit to answer the internal call, where both internal callers can talk.

- Intercom is established.

4 Press  on the first unit to transfer the external call to the called handset.

- The external call is transferred.





Note

If there is no answer from the called unit, press  to resume the external call.

9.7.3 Answer an external call during intercom

1 During intercom, a new call tone is emitted when there is an incoming external call.

2 Press  ( on the base) to exit intercom mode.

3 To pick up the external call, press  **Line 1** /  **Line 2** on the handset or  /  on the base station.







9.7.4 Switch between an internal and external call

During the call, press  to switch between an internal or external call.



9.7.5 Establish a three-party conference call

The conference call feature allows an external call to be shared with two handsets, one handset and another external call, or one handset and the base. The three parties can share the conversation and no network subscription is required.





9.7.5.1 Conferencing between two internal units and an external line

- 1 During the call, press  to put the external call on hold (the caller can no longer hear you).
 - The display shows the numbers of available units (base or handsets).
- 2 Scroll  to the number of the unit you wish to establish the conference call with and press  **Select**.
- 3 Press  on the called handset or  on the base to answer the internal call, where both internal callers can talk.
 - Intercom is established.
- 4 Press **Conf.** soft key or long press  on the first unit to start the three party conference.
 - **Conference** will be displayed on the screen once the conference call is established.

9.7.5.2 Conferencing between one internal unit and two external lines

- 1 During a call, press the line key (**Line 1** or **Line 2** soft key on the handset, or  or  on the base station) for a free line to make or answer a second external call and put the first external call on hold (the caller can no longer hear you).
- 2 When the second call is connected, press **Option** soft key, scroll  to



Conference, and press  **Select** to initiate the conference call.

- Conference will be displayed on the screen once the conference call is established.
- 3 To disconnect a single caller, press the corresponding line key (**Line 1** or **Line 2** soft key on the handset, or  or  on the base station) to place the caller you wish to keep speaking to on hold, and then press  key on the handset or  on the base to hang up the other caller. Then press the other line soft key to take the remaining call off hold and continue the conversation.

To hang up both lines, press  key on the handset or  on the base station.

9.8 Locate Handset

This feature enables you to locate a missing handset if the handset is in range and contains charged batteries.

- 1 Press  on the base station.
 - All the registered handsets start to ring.
 - Once a handset is found, press  **Silent** on a handset to stop its ringing.
- 2 Press  again to end the paging.

Note

If there are no key presses within 30 seconds, the handset and base station will automatically return to idle mode.

9.9 Clock and Alarm settings



This feature allows you to set the date, time and alarm settings for your phone.

Note



The alarm feature is available only on the handset.

The procedures in this section refer you to the **Clock & Alarm** menu. However if you access this menu from the base station, the menu name is “**Clock**”.

9.9.1 Set Date and Time

1 Press  in idle mode, scroll  to **Clock & Alarm** (**Clock** on the base), and press  **Select**.

2 **Set Date/Time** is highlighted. Press  **Select**.

3 The last stored date and time are displayed. Enter the current time and current date (HH:MM DD/MM/YY). Press  to move the cursor left, or press  to move it right. If using the 12 hour format, just after setting the minutes, use  to switch between AM and PM.

4 Press  **OK**.



- A validation tone is emitted and the screen returns to the idle mode.

Note



You can change the format as shown in the next section.

9.9.2 Set Time and Date Format

9.9.2.1 Set Time Format

1 Press  in idle mode, scroll  to **Clock & Alarm** (**Clock** on the base), and press  **Select**.



2 Scroll  to **Set Format** and press  **Select**.

3 **Time Format** is highlighted in the display. Press  **Select**, then scroll  to select **12Hours** or **24Hours**.

4 Press  **Select** to select the option.



- A validation tone is emitted and the screen returns to the **Set Format** menu.

9.9.2.2 Set Date Format

1 Press  in idle mode, scroll  to **Clock & Alarm** (**Clock** on the base), and press  **Select**.



2 Scroll  to **Set Format** and press  **Select**.

3 Scroll  to **Date Format** and press  **Select**.

4 Scroll  to select **DD/MM** or **MM/DD** and press  **Select** to select the option.

- A validation tone is emitted and the screen returns to the **Set Format** menu.

9.9.3 Set Alarm (Handset only)

1 Press  in idle mode, scroll  to **Clock & Alarm**, and press  **Select**.

- 2 Scroll to **Alarm** and press **Select**.
- 3 Scroll to **Off**, **On Once**, or **On Daily** and press **Select**.
- 4 If you select **On Once** or **On Daily**, enter the time (HH-MM) for the alarm. (If using the 12 hour format, you can switch between AM and PM by pressing key.) Press **OK** to confirm.
 - A validation tone is emitted and the screen returns to the **Alarm** menu. And the alarm icon is displayed.
 - If you select **Off**, a validation tone is emitted and the screen returns to the **Clock & Alarm** menu.

Note

The alarm tone and alarm icon will sound/blink for 1 minute when the alarm time is reached. To mute the alarm tone, simply press any key on the handset.

9.9.4 Set Alarm Tone (Handset only)

- 1 Press in idle mode, scroll to **Clock & Alarm**, and press **Select**.
- 2 Scroll to **Alarm Tone** and press **Select**.
- 3 Scroll to select the tone. (Three tones are available. The tones sound as you scroll.) Press **Select** to confirm your selection.
 - A validation tone is emitted and the screen returns to the **Clock & Alarm** menu.

10 Using your Phonebook

Your phone can store up to 200 phonebook entries. Each phonebook entry can have a maximum of 24 digits for the phone number and 14 characters for the name.

All names and numbers in the phonebook must be unique.

Note

Only one unit (handset or base station) can access the phonebook at a time.

10.1 Store a contact in the phonebook

- 1 Press in idle mode. **Phonebook** is highlighted. Press **Select**.
- 2 **New Entry** is highlighted. Press **Select**.
- 3 **Enter Name** is displayed. Enter the name of the contact (maximum 14 characters) and press **OK**.
- 4 **Enter Number** is displayed. Enter the number (maximum 24 digits) and press **OK**.
 - A validation tone is emitted.

Note

- Press **Clear** to delete the last digit or character entered or long press to delete all.
- To return to the previous menu, press **Back**.

* Tip

You cannot store a new phonebook entry when the memory is full. In this case, you have to delete existing entries to make space for new entries.

10.2 Access phonebook

- 1 Press **Ph. Book** in idle mode and scroll to browse the phonebook. (You can also access the phonebook through the menu mode. → **Phonebook** → **List**)

- The phonebook entries will be listed in alphabetical order.

- 2 To view the details, press **View**.

* Tip

Instead of scrolling to browse the phonebook entries, you can press the numeric key corresponding to the first letter of the entry you wish to locate. For example, pressing will show the entries starting with A. Pressing again will show the entries starting with B, etc.

- 3 Press (or on the base station) to dial the number. To return to idle mode press (or on the base station).

10.3 Modify a phonebook entry

- 1 Press in idle mode. **Phonebook** is highlighted. Press **Select**.
- 2 Scroll to **Edit Entry** and press **Select**.
- 3 Scroll to select an entry to edit.
- 4 Press **Select** to display the name.

- 5 Press **Clear** to erase the letters one by one.

- 6 Edit the name and press **OK** to confirm.

- 7 Edit the number and press **OK** to confirm.

- A validation tone is emitted.

Note

While editing, press **Clear** to delete the last digit or character entered or long press to delete all.

10.4 Select phonebook melody (Handset only)

With this function you can personalize the melody played when someone in the phonebook calls you.

Note

You need to subscribe to Caller Line Identification service to be able to benefit from this feature.







- 1 Press in idle mode. **Phonebook** is highlighted. Press **Select**.
- 2 Scroll to **Select Melody** and press **Select**.
- 3 Scroll to the entry you want to select a melody for, then press **View**.
- 4 The screen shows the melody currently selected for that entry. Press **Change** to change the melody.
- 5 Scroll the list of melodies. (There are 15 melodies plus **No Melody** to choose from. The melodies play as you scroll through them.)
- 6 Press **Select** to select the melody you prefer.

- A validation tone is emitted and the screen returns to the **Phonebook** menu.

Note

When first ring detection is set **On**, a normal tone sounds first, then it changes to the personalized phonebook melody. When it is set **Off**, the personalized phonebook melody plays from the start. See Section 13.13 for how to set first ring detection **On** or **Off**.





10.5 Delete a phonebook entry

- 1 Press  in idle mode. **Phonebook** is highlighted. Press  **Select**.
- 2 Scroll  to **Delete** and press  **Select**.
- 3 Scroll  to select an entry to delete and press  **Select**.
- 4 **Delete?** is displayed on the screen. Press  **OK** to confirm deletion.
 - A validation tone is emitted.



Note

Press  **Back** to discard the deletion. The screen returns to the phonebook list.



10.6 Delete all phonebook entries

- 1 Press  in idle mode. **Phonebook** is highlighted. Press  **Select**.
- 2 Scroll  to **Delete All** and press  **Select**.
- 3 **Delete All?** is displayed on the screen. Press  **OK** to confirm deletion.
 - A validation tone is emitted.











10.7 Direct Access Memory

There are 7 direct access memories (corresponding to keys  to ) included in the phonebook. A long press on any of these keys in idle mode invites you to select a line, then dials the phone number stored in the corresponding direct access memory.

Note

Key  is reserved for use with Voicemail in the network services menu. If you subscribe to this service, this allows you to dial your voice mail access number using key .

10.7.1 Add/Edit Direct Access Memory

- 1 Press  in idle mode. **Phonebook** is highlighted. Press  **Select**.
- 2 Scroll  to **Direct Memory** and press  **Select**.
- 3 Handset: Scroll  to the key you wish to edit (**Key 3** to **Key 9**) and press  **Select**.
Base: Scroll  or  to the key you wish to edit (**Key 3** to **Key 9**) and press **Select** soft key.
 - The current number stored in the direct access memory location will be displayed. If no number is stored, **No number** will be displayed.
- 4 Press  **Menu. Edit** is highlighted; press  **Select**.
- 5 The Phonebook list will be displayed. Scroll  to the Phonebook entry you wish to store in the selected direct access











memory number and press 

Select.

- Press  **OK** to confirm.
 - A validation tone is emitted and the screen returns to the previous menu.

10.7.2 Delete Direct Access

Memory

- Press  in idle mode. **Phonebook** is highlighted. Press  **Select.**
- Scroll  to **Direct Memory** and press  **Select.**
- Handset: Scroll  to the key you wish to delete the memory from.
Base: Scroll  or  to the key you wish to delete the memory from and press  **Select.**
- Press  **Menu**, and then scroll  to **Delete** and press  **Select.**
 - A validation tone is emitted and the screen returns to the previous menu.







withheld, the name (or number) of the caller will be displayed.

During CLI display, you can press  to toggle area code and long distance code display on/off.

Note

If the identity of the caller is withheld, then the information will not be displayed in the call log. If you have not subscribed to Caller Line Identification service, there will not be any caller information displayed in the call log.

11.1 Access the Call log







- Press  in idle mode, and scroll  to browse the call log.
 - The calls (missed and received) are displayed in chronological order with the most recent call at the top of the list. L1 or L2 indicates the line on which the call was received. If the call is unviewed and unanswered, **New** appears on the display. After you view the message, **New** disappears.
 - Press  to dial out the number of the selected call log entry.
- To view the call details, press  **Menu** and then press  **Select.** The display shows the caller information.
 - Press  **Back** at any time to return to the previous menu.

11 Using the Call log

The call log stores the last 50 external calls and any new voice mail received. In idle mode, **New Call(s)** appears on the handset or base display for new and unanswered calls. If you have subscribed to Caller Line Identification (CLI), and provided the identity of the caller is not

11.1.1 To choose the format for call log display

You must choose the correct format to dial the area code and number of the call log record chosen. The original incoming number from the call log will appear as a 7, 10 or 11-digit number.



- 1 When viewing the call log, press  to change the format of the call log display as it should be dialed from your location. For example, if the call log entry appears as “234-567-8900”:
 - Press  once to display “1-234-567-8900”
 - Press  twice to display “567-8900”
 - Press  3 times to display “1-567-8900”
 - Press  4 times to display “234-567-8900” again.
- 2 To dial the current displayed number, press  (or  on the base station).
 - The call is initiated.

Note







You need to subscribe to Caller Line Identification service to be able to see the caller's number or name in the call log (see section 11.1 - “Access the Call log”).

When you store an incoming number in the phonebook, the digits of the number will be saved exactly as they appear on the screen.

If the first 3 digits of the incoming number corresponds to the local area code set in your phone, they will be filtered automatically when you press the

 or  on the handset (or  on the base station) to dial. To change the local area code, see section 13.9 - “Set Area Code.”







11.2 Save call list entry into the phonebook

- 1 Press  in idle mode, then scroll  to select an entry and press  **Menu**.
- 2 Scroll  to **Save Number** and press  **Select**.
- 3 **Enter Name** is displayed on the screen. Enter the name of the contact (maximum 14 characters) and press  **OK**.
- 4 **Enter Number** is displayed and the selected number from the call list appears in the number field. At this time you can edit the number if you wish to.
- 5 Press  **OK**.
 - A confirmation tone sounds and the screen returns to call log.

Note

Press  **Clear** to delete the last digit or character entered or long press to delete all.

11.3 Delete a call list entry





- 1 Press  in idle mode, then scroll  to select an entry and press  **Menu**.
- 2 Scroll  to **Delete** and press  **Select**.
- 3 **Delete?** is displayed on the screen. Press  **OK** to confirm deletion.

- A validation tone is emitted, the call list entry is deleted, and the display goes to the next entry in the call list.

Note

Press  **Back** to discard the deletion. The screen returns to the **Call List** menu.

11.4 Delete all call list entries

- 1 Press  in idle mode, then press  **Menu**.
- 2 Scroll  to **Delete All** and press  **Select**.
- 3 **Delete All?** is displayed on the screen. Press  **OK** to confirm deletion.
 - A validation tone is emitted. The display shows **List Empty** for 2 seconds and returns to the idle mode.

- 3 The last stored name is displayed. Press  **Clear** to delete the characters one by one or a long press to delete all.

- 4 Enter the new name and press  **OK** to confirm.

- A validation tone is emitted and the screen returns to the **Personal Set** menu.

12.2 Ring Settings







12.2.1 Set the Ring Volume

Danger

When the handset rings during an incoming call, please do not hold the handset too close to your ear as the volume of the ringing tone may damage your hearing.

You can set the ring volume independently for each registered handset, as well as the base station. Handsets have 5 ring volume levels, plus progressive and off. The base station has 5 ringer volume levels plus off. The default setting for both handsets and the base station is level 3.





To adjust ring volume on the handset:

- 1 Press  in idle mode, scroll  to **Personal Set**, and press  **Select**.
- 2 Scroll  to **Handset Tones** and press  **Select**. **Ring Volume** is highlighted. Press  **Select**.

12 Personal settings

12.1 Change the Handset Name (Handset only)

You can name the handset and display the handset name in idle mode. The default handset name of your handset is Philips.

- 1 Press  in idle mode, scroll  to **Personal Set** and press  **Select**.
- 2 **Handset Name** is highlighted. Press  **Select**.

- 3 Scroll to select **Line 1** or **Line 2** and press **Select**.
- 4 Scroll to your desired volume level. The ring tone sounds at each level.
- 5 Press **OK** to confirm.
 - A validation tone is emitted and the screen returns to the **Handset Tones** menu.

To adjust ring volume on the base station:

- 1 Press or in idle mode; **Select line** appears.
- 2 Press **Line 1** or **Line 2** to select the line whose ring volume is being adjusted.
- 3 Press or to adjust the ring volume on the selected line.

Note

If ring volume is set to off, the icon will be displayed on the screen.

If ring volume is set to progressive (handset only), the ringer will start at level 1 and go up one level volume every ring.

12.2.2 Set the Ring Tones

There are 15 ring tones available on your handset, and 5 ring tones available for the base.

- 1 Press in idle mode, scroll to **Personal Set**, and press **Select**.
- 2 Scroll to **Handset Tones** on the handset or **Base Tones** on the base and press **Select**. Then

scroll to **Ring Tones** and press **Select**.

- 3 Scroll to select **Line 1** or **Line 2** and press **Select**.
- 4 Scroll to your desired melody. The melodies will play as you scroll them.
- 5 Press **Select** to set the ring tone.
 - A validation tone is emitted and the screen returns to the previous menu.







12.2.3 Activate/Deactivate Key Beep

A single beep tone is emitted when a key is pressed. You can enable or disable the key beep.

- 1 Press in idle mode, scroll to **Personal Set**, and press **Select**.
- 2 Scroll to **Handset Tones** on the handset or to **Base Tones** on the base and press **Select**. Then scroll to **Key Beep** and press **Select**.
- 3 Scroll to select **On** or **Off** and press **Select** to confirm.
 - A validation tone is emitted and the screen returns to the previous menu.

12.3 Change the Display Language

Your handset and base can support different display languages.







- 1 Press  in idle mode, scroll  to **Personal Set**, and press  **Select**.
- 2 Scroll  to **Language** and press  **Select**.
- 3 Scroll  to your desired language and press  **Select** to confirm.
 - A validation tone is emitted and the screen returns to the **Personal Set** menu.

Note

Once the display language is set, the option menus on the unit will immediately switch to display in the selected language.







12.4 Select the Display Wallpaper (Handset only)

There are 3 wallpaper images available on your handset as well as an option to set it off.

- 1 Press  in idle mode, scroll  to **Personal Set**, and press  **Select**.
- 2 Scroll  to **Wallpaper** and press  **Select**.
- 3 Scroll  to your desired wallpaper. The image on the display will change as you scroll.
- 4 Press  **Select** to confirm.
 - A validation tone is emitted and the screen returns to the **Personal Set** menu.







12.5 Select the Color Theme (Handset only)

There are 4 color themes available on your handset.

- 1 Press  in idle mode, scroll  to **Personal Set**, and press  **Select**.
- 2 Scroll  to **Color Theme** and press  **Select**.
- 3 Scroll  to your desired color theme. The color theme used on the display will change as you scroll.
- 4 Press  **Select** to confirm.
 - A validation tone is emitted and the screen returns to the **Personal Set** menu.







12.6 Set the Display Contrast

You can change the contrast of the text on the display. There are 5 contrast levels available. The default is level 3.

- 1 Press  in idle mode, scroll  to **Personal Set**, and press  **Select**.
- 2 Scroll  to **Contrast** and press  **Select**.
- 3 Scroll  to the desired display contrast, and press  **Select** to confirm.
 - A validation tone is emitted and the screen returns to the **Personal Set** menu.

12.7 Set the Backlight Time (Handset only)







You can change the backlight timing for the display. There are 3 options available - 20, 40, or 60 seconds.

- 1 Press  in idle mode, scroll  to **Personal Set**, and press  **Select**.
- 2 Scroll  to **Backlight Time** and press  **Select**.
- 3 Scroll  to the desired backlight time, and press  **Select** to confirm.
 - A validation tone is emitted and the screen returns to the **Personal Set** menu.

12.8 Deactivate/Activate Auto Hang-Up (Handset only)

If auto hang-up is set to On, it will automatically release the line when the phone is put back on the cradle. If auto Hang-up is set to Off, putting the handset back on the cradle while in talk mode will switch the handset to hands free talk mode. This allows you to charge the handset during calls.



The default setting for auto hang up is On.



- 1 Press  in idle mode, scroll  to **Personal Set**, and press  **Select**.
- 2 Scroll  to **Auto Hang-up** and press  **Select**.
- 3 Scroll  to **On** or **Off** and press  **Select** to confirm.
 - A validation tone is emitted and the screen returns to the **Personal Set** menu.













12.9 Changing the Line Setting (Base Station only)

Note

See section 13.14 for how to change the line setting from the handset.

If you have two telephone lines connected to the base unit, the line setting determines how the lines are selected when making or receiving calls. When “auto” is selected as the line setting, pressing  automatically connects the line that is currently free when making outgoing calls, or the line that is ringing when receiving an incoming call. (If both lines are in the same state, line 1 takes priority.) If Auto Conference is activated, pressing  lets the base station join a conversation between the external call on line 1 and another unit.

If **Line 1** or **Line 2** is selected as default and the corresponding line is free, pressing  automatically connects to that line when making outgoing calls, or when receiving an incoming call on that line. If **Auto Conference** is activated, pressing  lets the base station join a conversation on the selected line between an external caller and another unit.

- 1 Press  in idle mode, scroll     to **Personal Set** and press **Select** soft key.
- 2 Scroll     to **Line Setting** and press **Select** soft key.
- 3 Scroll     to select **Auto, Line 1**, or **Line 2** and press **Select** soft key.

- A validation tone is emitted and the screen returns to the **Personal Set** menu.

13 Advanced settings







These settings can be made from any registered SE659 handset. They cannot be made from the base station.



13.1 Easy Call

When activated, this feature allows you to dial a preset number by pressing any key on the handset (except  **Cancel**). This feature is useful for fast access to emergency services.

13.1.1 Set Easy Call to On or Off

Follow this procedure to switch Easy Call on. To switch Easy Call off, see the Note at the end of this section.





- 1 Press  in idle mode, scroll  to **Advanced Set** and press  **Select**.
- 2 **Easy Call** is highlighted. Press  **Select** to enter the Easy Call menu.
- 3 **Mode** is highlighted in the display. Press  **Select** again to select **Mode**, then scroll  to **On**.
- 4 Press  **Select** to confirm the selection.

- If an Easy Call number has not been set, you will be prompted to input the Easy Call number.
- If an Easy call number has already been set, the screen returns to idle mode. If you want to edit the number, press  **Cancel** and scroll to **Number** and press  **Select**, edit the new number and press  **OK**.









Note

When you switch Easy Call on, **Easy Call On** will be displayed on your screen in standby mode. You can still answer any incoming call as normal.







To switch Easy Call off from idle mode, press  **Cancel**. **Mode** is highlighted in the display. Press  **Select** again to select **Mode**, and then scroll  to **Off**. Press  **Select** to confirm.

13.1.2 Set Easy Call number

- 1 Press  in idle mode, scroll  to **Advanced Set** and press  **Select**.
- 2 **Easy Call** is highlighted in the display. Press  **Select** to enter the Easy Call menu.
- 3 **Mode** is highlighted in the display. Scroll  to **Number** and press  **Select**.
- 4 Input the Easy Call number.
- 5 Press  **OK** to confirm.
 - A validation tone is emitted and the screen returns to the **Easy Call** menu.

13.2 Auto Conference

If activated, this feature allows another handset to join a conversation with an external call by simply pressing . The default setting is **On**.

- 1 Press  in idle mode, scroll  to **Advanced Set** and press  **Select**.
- 2 Scroll  to **Conference** and press  **Select**.
- 3 Scroll  to select **On** or **Off** and press  **Select** to confirm.
 - A validation tone is emitted and the screen returns to the **Advanced Set** menu.

13.3 Call Barring





If activated, this function prevents dialing out to numbers beginning with designated barring numbers. This is useful for preventing outgoing long distance calls or calls to specific prefixes. You can store up to four numbers, each with up to 4 digits.





Note

If you switch call barring on, **Call Barr On** is displayed on the screen in idle mode. By default call barring is off.





13.3.1 Set Call Barring Mode

By default, Call Barring is **OFF**.











- 1 Press  in idle mode, scroll  to **Advanced Set** and press  **Select**.
- 2 Scroll  to **Call Barring** and press  **Select**.

- 3 Scroll  to select **Line 1** or **Line 2** and press  **Select**.
- 4 Enter the PIN number.
 - If you enter and incorrect PIN number, an error tone will sound and “Wrong PIN!” will be displayed. Then, the display will return to idle screen.
- 5 **Mode** is highlighted in the display. Press  **Select**.
- 6 Scroll  to select **On** or **Off** and press  **Select** to confirm.
 - If a Call Barring number has not been set, you will be prompted to input a Call Barring number.

Note

To switch Call Barring mode off again from idle mode, press  **Cancel** and enter the PIN number. **Mode** is highlighted in the display. Press  **Select** to select **Mode**, then scroll  to **Off** and press  **Select**.

13.3.2 Set a Call Barring number

- 1 Press  in idle mode, scroll  to **Advanced Set** and press  **Select**.
- 2 Scroll  to **Call Barring** and press  **Select**.
- 3 Scroll  to select **Line 1** or **Line 2** and press  **Select**.
- 4 Enter the PIN number.
- 5 **Mode** is highlighted in the display. Scroll  to **Number** and press  **Select**.
- 6 Scroll  to select a call barring number location, and press  **Select** to confirm.

- Input the call barring number (up to 4 digits) and press **OK**.
 - A validation tone is emitted and the screen returns to the **Call Barring** menu.

13.4 XHD Sound

XHD (extra high definition) Sound can increase voice quality when **On**. The default setting is **On**.

To turn it off:

- Press in idle mode, scroll to **Advanced Set** and press **Select**.
- Scroll to **XHD Sound** and press **Select**.
- Scroll to select **On** or **Off** and press **Select** to confirm.
 - A validation tone is emitted and the screen returns to the **Advanced Set** menu.

13.5 Change PIN

The PIN is used for setting call barring numbers and registration/unregistration of handsets. The default PIN number is 0000. This PIN is also used to protect the settings of your handset. Your handset will prompt you whenever the PIN is required.

Note

The default PIN code is preset to 0000. If you change this PIN code, keep the PIN details in a safe place where you have easy access to them. Do not lose the PIN code.

- Press in idle mode, scroll to **Advanced Set** and press **Select**.
- Scroll to **Change PIN** and press **Select**.
- Old PIN:** will be displayed. Enter the current PIN and press **OK**.
 - The PIN entered will be shown as asterisks (*) on the screen.
 - If you enter an incorrect PIN number, an error tone will sound and “Wrong PIN!” will be displayed. Then, you will be prompted to enter the current PIN again.
- New PIN:** will be displayed. Enter the new PIN and press **OK**.
- Confirm PIN:** will be displayed. Enter the new PIN again and press **OK** to confirm PIN change.
 - A validation tone is emitted, **Saved!** is displayed and the screen returns to the **Advanced Set** menu.

Tip

If you forget your PIN, you will need to reset your phone to its default settings. For more details, see section 13.8 - “Reset Unit.”

13.6 Registration

If you wish to register an additional handset or if you have inadvertently unregistered your phone's handset and want to re-register it, follow the procedure described below. This is the procedure for registering SE65 handsets. Procedures may vary for other types of

handsets. In this case, please refer to the manufacturer of the handset. Additional handsets must be registered to the base station before you can use them. Up to 8 handsets can be registered to one base station. The PIN is required before you can register or unregister handsets.

Note

By default, the PIN is 0000.

13.6.1 Easy registration

- 1 Insert the unregistered handset in the base station to automatically begin registration.
- 2 **Registering...** is displayed on the screen.
 - Upon successful registration, a validation tone is emitted and the handset number (1 to 8) will be assigned by the base automatically.

Note







Easy registration is possible only when the PIN has not been changed and is still the default PIN, 0000.

13.6.2 Manual registration

- 1 On the base station, press and hold  for 3 seconds. A beep sounds to indicate that the base is ready to accept registration.









Note

If no action is taken on the handset within 90 seconds, the registration procedure will be aborted. If this happens, repeat from Step 1.

- 2 On the handset, press , scroll  to **Advanced Set** and press  to **Select**.
- 3 Scroll  to **Register** and press  to **Select**.
- 4 Enter the PIN when prompted and press  **OK** to confirm. **Registering...** is displayed on the screen.

- Upon successful registration, a validation tone is emitted and the handset number (1 to 8) will be assigned by the base automatically.

13.7 Unregister

- 1 Press  in idle mode, scroll  to **Advanced Set** and press  to **Select**.
- 2 Scroll  to **Unregister** and press  to **Select**.
- 3 Enter the PIN when prompted and press  **OK** to confirm.
- 4 Scroll  to select the handset number to unregister and press  to **Select**. Press  **OK** to confirm.
 - A validation tone is emitted to indicate successful unregistration.

Note

You can only use a SE659 handset to unregister a handset that does not belong to the SE659 range.

13.8 Reset Unit







You can reset your phone to its default settings with this feature. (see 13.15 “Default Settings”)

Caution

Upon reset, all your personal settings, call log and redial list entries will be deleted and the phone will return to its default settings. However, your phonebook will remain unchanged after reset.

Note

You may have to configure your phone once again.

- 1 Press  in idle mode, scroll  to **Advanced Set** and press  **Select**.
- 2 Scroll  to **Reset** and press  **Select**.
- 3 **Reset?** is displayed on the screen. Press  **OK** to confirm.
 - A validation tone is emitted.
 - The unit is reset to its default settings. (See section 13.15 below.)

13.9 Set Area Code









This feature is useful when you have subscribed to Caller Line Identification service. It allows you to set an area code in your phone. Once the local area code is set, the phone automatically filters the area code for all incoming calls, by removing the area code for local calls and retaining the area code for calls from other areas.

If it is a local call, then only the phone number of the caller is displayed during

an incoming call or when you call the number from the call log. If it is a long distance call, then both the area code and phone number will be displayed in a proper format to be dialed out directly from the call log, or saved into the phonebook.

Note









You can enter 3 digits for the area code. You need to subscribe to Caller Line Identification service to be able to see the caller's number or name in the call log. See 8.1.4 “Call from the call log” for details.

- 1 Press  in idle mode, scroll  to **Advanced Set** and press  **Select**.
- 2 Scroll  to **Area Code** and press  **Select**.
- 3 Scroll  to select **Line 1** or **Line 2** and press  **Select**.
- 4 **Area Code** will appear in the display. Input your area code and press  **OK** to confirm.
 - A validation tone is emitted and the screen returns to the **Advanced Set** menu.

13.10 Set Auto Prefix

This feature allows you to define a prefix number to be added to the beginning of a number during predialling (see “Predialling” - section 8.1.1). You may also use this feature to add a detect string to match and replace the first few digits of the number during predialing.

You can enter up to a maximum of 5 digits for the detect string and 10 digits for the auto prefix number.

- 1 Press  in idle mode, scroll  to **Advanced Set** and press  **Select**.
- 2 Scroll  to **Auto Prefix** and press  **Select**.
- 3 Scroll  to select **Line 1** or **Line 2** and press  **Select**.
- 4 **Detect Digit:** is displayed on the screen. Enter a detect string number (maximum 5 digits) and press  **OK** to confirm.
- 5 **Prefix:** is displayed on the screen. Enter the prefix number (maximum 10 digits) and press  **OK** to confirm.
 - A validation tone is emitted and the screen returns to the **Advanced Set** menu.



Note





If no detect string (blank) is entered, the prefix number will be automatically added to the predial number after  is pressed.

For numbers starting with *, # or P, the prefix number will not be added to the predial number after  is pressed.

13.11 Change Flash time

Flash time is the time delay by which the line will be disconnected after you press the  key. It can be set to short or long. The default value is **Long**.

- 1 Press  in idle mode, scroll  to **Advanced Set**, and press  **Select**.









- 2 Scroll  to **Flash Time** and press  **Select**.
- 3 Scroll  to **Short** or **Long** and press  **Select** to confirm.
 - A validation tone is emitted and the screen returns to the **Advanced Set** menu.

Note

The use of your SE659 cannot be guaranteed on all PABX.

13.12 Change the Dial Mode









The default value for dial mode that is preset in your handset should be the best suited for your subscribed network and therefore you should not need to change it.

- 1 Press  in idle mode, scroll  to **Advanced Set**, and press  **Select**.
- 2 Scroll  to **Dial Mode** and press  **Select**.
- 3 Scroll  to select **Line 1** or **Line 2** and press  **Select**.
- 4 Scroll  to **Tone** or **Pulse** and press  **Select** to confirm.
 - A validation tone is emitted and the screen returns to the **Advanced Set** menu.

13.13 Set First Ring Detection

First ring detection allows the phone to ring upon reception of the first ring signal. It is recommended that you set first ring detection **Off** if you subscribe to caller line identification service. (When using personalized phonebook

melodies, this will prevent a normal ring tone from sounding before a melody starts playing.) If you do not subscribe to caller line identification service, it is recommended that you set first ring detection **On**. (See Section 10.4.)

- 1 Press  in idle mode, scroll  to **Advanced Set**, and press  **Select**.
- 2 Scroll  to **First Ring** and press  **Select**.
- 3 Scroll  to select **Line 1** or **Line 2** and press  **Select**.
- 4 Scroll  to **On** or **Off** and press  **Select** to confirm.
 - A validation tone is emitted and the screen returns to the **Advanced Set** menu.

Note



The default setting for first ring detection is **On**. The setting automatically switches to **Off** when you receive a call containing caller line identification. However, this occurs only if you do not first manually change the setting. (It does not change automatically if you manually change the first ring setting even once.)





13.14 Changing the Line Setting (Handset only)







Note

See section 12.9 for how to change the line setting from the base station.

If you have two telephone lines connected to the base unit, the line

setting determines how the lines are selected when making or receiving calls. When “auto” is selected as the line setting, pressing  or  automatically connects the line that is currently free when making outgoing calls, or the line that is ringing when receiving an incoming call. (If both lines are in the same state, line 1 takes priority.) If **Auto Conference** is activated, pressing  lets the handset join a conversation between the external call on line 1 and another handset.

If **Line 1** or **Line 2** is selected as default and the corresponding line is free, pressing  or  automatically connects to that line when making outgoing calls, or when receiving an incoming call on that line. If **Auto Conference** is activated, pressing  or  lets the handset join a conversation on the selected line between an external caller and another unit.

- 1 Press  in idle mode, scroll  to **Advanced Set** and press  **Select**.
- 2 Scroll  to **Line Setting** and press  **Select**.
- 3 Scroll  to select **Auto**, **Line 1**, or **Line 2** and press  **Select**.
 - A validation tone is emitted and the screen returns to the **Advanced Set** menu.

13.15 Default Settings

Parameter	Default Value
Ring Volume	Level 3
Ring Tone	Ring 1
Earpiece Volume	Level 3
Speaker Volume	Level 3
Key Beep	On
Display Language	English
Wallpaper	Wallpaper 1
Color Theme	Color 1
Display Contrast	Level 3
Backlight Time	20 Seconds
Auto Hang-Up	On
Handset Name	Philips
Time/Date Format	MM/DD 12Hours
Time/Date	00:00 01/01/2008
Set Alarm	Off
Alarm Tone	Bell 2
Dial Mode	Tone
Flash Time	Long
PIN Code	0000
Call Barring	Off
Call Barring Number	Cleared
XHD Sound	On
Easy Call	Off
Easy Call Number	Cleared
Auto Prefix	Cleared
Set First Ring	On

Parameter	Default Value
Line Setting	Auto
Phonebook Memory	After a reset, phonebook is maintained as it was just before the reset
Redial Memory	Cleared
CLI Memory	Cleared
Network Service	Empty (no preset numbers)
Auto Conference	On

14 Network Service









The network service function provides a convenient way for you to access some network provider services. A subscription is required in order to benefit from this service. Contact your network provider for details. Depending on your subscribed network, this service and menus described in this chapter may not be available in your SE659.

This setting can be made from any registered SE659 handset. It cannot be made from the base station.

14.1 Voice Mail

Use this function to access your voice mail account.











14.1.1 Access Voice Mail

- 1 Press  in idle mode, scroll  to **Netw. Services**, and press  **Select**.
- 2 Scroll  to select **Line 1** or **Line 2** and press  **Select**.
- 3 Scroll  to **Voice mail** and press  **Select**.
- 4 You are now at the **Voice mail** menu and **Call** is highlighted. Press  **Select** to connect to the voice mail account number.

Note

You can also access your voice mail number by long-pressing .

14.1.2 Set Voice Mail Number

- 1 Press  in idle mode, scroll  to **Netw. Services**, and press  **Select**.
- 2 Scroll  to select **Line 1** or **Line 2** and press  **Select**.
- 3 Scroll  to **Voice mail** and press  **Select**.
- 4 Scroll  to **Settings** and press  **Select**.
- 5 Enter the voice mail account number (maximum 14 digits) and press  **OK**.
 - A confirmation tone will sound and the display will return to the **Voice mail** screen.

15 Telephone answering machine (TAM)

Both telephone lines of your phone feature an answering machine that records unanswered calls when it is activated. The answering machine can store up to 59 messages for each line. The maximum recording time is 3 minutes per message, or 30 minutes for all messages on both lines. The maximum length of an outgoing message is 1 minute. You can use the control keys on the base station to perform the basic functions of the answering machine such as message playback, deleting messages and adjustment of volume on the base station. For a description of each function of the control keys on the base station, please see "Overview of the base station" (section 5.4) for more details. You can also use the answering machine menu to access the answering machine functions. (Functions available differ depending on whether you are using the menu on the handset or the base station.) Those procedures are covered below. There is also a menu to set the answering machine options.





The telephone answering machine is ON by default. To switch the answering machine between on and off, press  on your base station. Alternatively, you may

switch the answering machine on and off via your handset (see section 15.6.2).



15.1 Playing Messages

15.1.1 Playback of messages via handset

The answering machine message counter blinks when there are new messages and display the number of new messages. The first recorded message is played first via the loudspeaker. When all new messages have been played, the answering machine will stop and the message counter will stop blinking.

- 1 Press the  key in idle mode, scroll  to **Answer Machine**, and press  **Select**.
- 2 Press  **Select**.
- 3 Scroll to **Line 1** or **Line 2** and press  **Select** to start playing new messages.
 - The handset displays **New** and the number of new messages in the format **01/04**, where **01** is the number of the message being played and **04** is the number of new messages.
 - If there are no new messages, the handset displays the number of old messages in the same format (however 'New' is not displayed.) and plays the old messages.

15.1.2 Functions available during playback

During playback, you can enable the following functions by pressing  **Menu**. Use  to scroll between the functions and press  **Select** to confirm.

Repeat	Replay the current message
Next	Listen to the next message.
Previous	Listen to the previous message.
Delete	Delete the message currently playing.









15.2 Delete all messages from the handset

Warning

Deleted messages cannot be recovered.









Note

Unplayed messages will not be deleted.

- 1 Press the  key in idle mode, scroll  to **Answer Machine**, and press  **Select**.
- 2 Scroll  to **Delete All** and press  **Select**.
- 3 Scroll  to select **Line 1** or **Line 2** and press  **Select**.
- 4 **Delete All?** is displayed on the screen. Press  **OK** to confirm deletion of all your messages.
 - **Waiting...** is displayed while the messages are deleted; then, **Deleted** is displayed for 2 seconds, and the display returns to the **Answer Machine** menu.

15.3 Turn the Answering Machine On/Off from the Handset

You can turn the answering machine on or off from the handset as follows.











- 1 Press the  key in idle mode, scroll  to **Answer Machine**, and press  **Select**.
- 2 Scroll  to **Answer On/Off** and press  **Select**.
- 3 Scroll  to select **Line 1** or **Line 2** and press  **Select**.
- 4 Scroll  to select **On** or **Off** and press  **Select**.
 - A validation tone is emitted and the screen returns to **Answer Machine** menu.

15.4 Play, Record, or Delete an Outgoing Message

You can record a personalized message to be played when the answering machine picks up an incoming call.

Note









The maximum length of an outgoing message is 1 minute.

- 1 Press the  key in idle mode, scroll  to **Answer Machine**, and press  **Select**.
- 2 Scroll  to **Record OGM** and press  **Select**.
- 3 Scroll  to select **Line 1** or **Line 2** and press  **Select**.
- 4 Scroll  to select **Answer & Rec.** or **Answer Only** and press  **Select**.
- 5 Scroll  to select **Play, Record Message, or Delete** and press  **Select**.

- If **Play** is selected, the current outgoing message is played.
- If **Record Message** is selected, a beep sounds and message recording starts automatically.
- If **Delete** is selected and a personal outgoing message was previously recorded, **Deleted** is displayed. The predefined OGM is reinstated automatically.

15.5 Set the Answer mode

There are 2 answer modes available: Answer Only and Answer & Record. By default, the answer mode is Answer & Record, which lets your caller leave a message on the answering machine. This can be changed to Answer Only mode, which does not allow your caller to leave any messages on the answering machine.

- 1 Press the  key in idle mode, scroll  to **Answer Machine**, and press  **Select**.
- 2 Scroll  to **Answer Mode** and press  **Select**.
- 3 Scroll  to select **Line 1** or **Line 2** and press  **Select**.
- 4 Scroll  to select **Answer & Rec.** or **Answer Only** and press  **Select**.
 - A validation tone is emitted and the screen returns to **Answer Machine** menu.

Note

Depending on the answer mode you have selected, the appropriate default outgoing

message is played once the answering machine picks up an incoming call.











* Tip

You can set the answering machine to play a personalized outgoing message. See 15.4 above.

15.6 Answering Machine Settings

15.6.1 Ring Delay

This is the number of rings before the answering machine answers and starts playing your greeting message. You can set the answering machine to start playing your greeting message after 3 to 8 rings or the “Economy” option. The default ring delay is Economy.

- 1 Press the  key in idle mode, scroll  to **Answer Machine**, and press  **Select**.
- 2 Scroll  to **Settings** and press  **Select**.
- 3 **Ring Delay** is highlighted. Press  **Select**.
- 4 Scroll  to select **Line 1** or **Line 2** and press  **Select**.
- 5 Scroll  key to select from **3** to **8** or **Economy**, and press  **Select** to confirm.
 - A validation tone is emitted and the display returns to the **Settings** menu.

⊖ Note

If **Economy** is selected, the ring delay depends on the answering machine's condition.

- If there are new messages in the answering machine, it will pick up the line after 2 rings.
- If there are no new messages in the answering machine, it will pick up the line after 4 rings.
- Hence, if you want to check if you have any messages without incurring call charges, you can hang up the call after the 3rd ring.









15.6.2 Remote Access

You can check the messages on your answering machine by calling in from an outside line and entering the remote access code*. The keypad on the phone you use to dial in acts like the functions on your answering machine.

⊖ Note

This feature is deactivated by default.
* The remote access code (which is the same as your PIN code) prevents any unauthorised remote access of your answering machine.

15.6.2.1 Activate/Deactivate Remote Access

- 1 Press the  key in idle mode, scroll  to **Answer Machine**, and press  **Select**.
- 2 Scroll  to **Settings** and press  **Select**. Then, scroll  to **Remote Access** and press  **Select**.
- 3 Scroll  to select **Activate** or **Deactivate** and press  **Select**.

- A validation tone is emitted and the screen returns to **Settings** menu.

15.6.2.2 Controlling the Answering Machine from an external call

- 1 From your external phone, dial home.
 - The answering machine answers and starts playing your greeting message.
- 2 Press # key and a voice prompt invites you to enter your PIN code. Enter the remote access code (same as your PIN code).
 - If the access code is incorrect, a voice prompt "Security code error, please enter again" will sound.
 - If the remote access code is correct, a short validation tone will be heard.



Note

Operation is cancelled if the PIN code is not entered within 8 seconds. If the answering machine is off, the phone will enter into the remote access mode after 10 rings. A voice prompt invites you to enter the PIN code. Enter the PIN (default is 0000) to activate the remote access feature. You can then turn ON the answering machine and play the recorded messages.

The following table indicates how to access the functions of the answering machine using the telephone keypad.









Key	Action
1	Go to previous message.
2	Play the message.
3	Skip to the next message.
6	Delete the playing message.
7	Turn on the answering machine.
8	Stop message playback.
9	Turn off the answering machine.

15.6.3 Handset Screening

When Handset call screening is set to **On**, you can press  **Screen** to start call screening for incoming messages. If you decide to pick up the call, press . Once you pick up, the recording will stop automatically.











Note

If you have multiple handsets, only one handset can enable handset call screening for each call.

- 1 Press the  key in idle mode, scroll  to **Answering Machine**, and press  **Select**.
- 2 Scroll  to **Settings** and press  **Select**. Then, scroll  to **HS Screening** and press  **Select**.
- 3 Scroll  to select **On** or **Off** and press  **Select**.
 - A validation tone is emitted and the screen returns to **Settings** menu.

15.6.4 Setting the Outgoing Message Language

The language of the default outgoing messages and the voice prompts is originally set to English. However you can change the language of the default outgoing messages as follows.

- 1 Press the  key in idle mode, scroll  to **Answer Machine**, and press  **Select**.
- 2 Scroll  to **Settings** and press  **Select**. Then, scroll  to **Voice Language** and press  **Select**.
- 3 Scroll  to select **Line 1** or **Line 2** and press  **Select**.
- 4 Scroll  to select the language and press  **Select**.
 - A validation tone is emitted and the screen returns to **Settings** menu.

Phonebook list, Redial list and Call log

- Phonebook list with 200 entries
- Redial list with 10 entries
- Call log with 50 entries

Battery

- 2 × AAA, 600mAh batteries

Radio specifications

- Frequency Band: 1920 - 1930Mhz
- Maximum output power: 120mW

Weight and dimensions

Base:

- 403 grams
- 64.5mm × 123.5mm × 199.5mm (H × D × W)

Handset:

- 128.5 grams
- 160mm × 28mm × 46mm (H × D × W)

16 Technical data

Display

- Color LCD with backlight
- Selectable wallpaper
- Selectable color theme

General telephone features

- Caller name & number identification
- 5 standard + 10 polyphonic ringer melodies on the handset, and 5 standard ringer melodies on the base station
- Wideband synthesis for receiver and loudspeaker

Temperature range

- Operation: Between 0 and 35°C (32 to 95°F).
- Storage: Between -20 and 70°C (-4 to 158°F).

Relative humidity

- Operation: Up to 95% at 40°C
- Storage: Up to 95% at 40°C

17 Frequently asked questions

www.philips.com/support

In this chapter, you will find the most frequently asked questions and answers about your phone.

17.1 Connection

The handset does not switch on!

- Charge the batteries: Put the handset on the base station to charge. After a few moments, the phone will switch on.
- You may have accidentally switched off the handset. In this case, press and hold  for at least 1 second to switch it on again (see section 9.1 - "Switch the handset off/on").

The handset does not charge!

- Check charger connections.

icon is not blinking during charge!

- Battery is full: There is no need to charge the battery.
- Bad battery contact: Adjust the handset slightly.
- Dirty contact: Clean the batteries contact with a cloth moistened with alcohol.

Communication is lost during a call!

- Charge the battery
- Move closer to the base station.

The phone is "Out of range"!

- Move closer to the base station.
-

17.2 Set-up

Searching... is displayed on handset and icon is blinking!

- Move closer to the base station.
 - Make sure that your base station is on.
 - Reset your unit and restart handset registration.
-

17.3 Sound

Handset does not ring!

Check that the **Ring Volume** is not set to no bars (Ringer Off), and make sure the  icon is not displayed on the screen (see section 12.2.1 - "Set the Ring Volume").

Caller does not hear me!

Microphone may be muted: During a call, press .

There's no dialling tone!

- No power: Check the connections.
- Batteries are empty: Charge the batteries.
- Move closer to the base station.
- Wrong line cord(s) used: Use the line cord(s) provided.
- Line adaptor is required: Connect the line adaptor to the line cord(s).

Caller does not hear me clearly!

- Move closer to the base station.
- Move the base station at least one metre away from any electronic appliances.

Frequent noise interference on my radio or television!

- Move the base station as far away as possible from the electrical appliances.

17.4 Product behaviour**Keypad does not work!**

- Unlock your keypad: Long press  in idle mode.

The handset warms up when making a long call and when it is on the base station!

- This is a normal behavior. The handset consumes energy while calling and charging.

The handset cannot be registered to the base station!

- Maximum number of handsets (8) has been reached. To register a new handset, unregister an existing handset.
- Remove and replace the handset batteries.
- Try again by disconnecting and connecting the base station power supply and follow the procedure to register a handset (see section 13.6).

Caller number is not displayed!

- Service is not activated: Check your subscription with your network operator.

I cannot change the settings of my voice mail!

- Operator voice mail is managed by your operator and not the phone itself. Please contact your operator should you want to change the settings.

My handset keeps going into idle mode!

- If there are no key presses for 30 seconds, the handset will automatically return to idle mode. It will also return to idle mode automatically when you place the handset back on the base station (if auto hang-up feature is on).

Phonebook entry cannot be stored and Memory Full is displayed!

- Delete an entry to free memory before saving your contact again.

The PIN code is wrong!

- The default PIN is 0000.
- Reset the handset to revert to the default PIN code if it has been changed before (see “Reset Unit” - Section 13.8).

The answering machine does not record calls.

- Make sure the answering machine is connected to the power adaptor, and

the power adaptor is plugged into mains supply which is switched on.

- Check if the answer machine is off, or Answer only mode is selected.
- Check to see if the answering machine is memory full. If so, delete some or all messages.
- Try switching off the power at the mains socket, and then turn it on again after 1 minute.

Unable to perform remote operation

- Make sure the remote access is on (see Section 15.6.2).
- Make sure you entered the correct remote access code.
- Use a touch-tone phone.

Note

If the above solutions do not help, remove the power from both the handset and the base. Wait for 1 minute and try again.

18 INDEX

A

- Access phonebook 44
- Access Redial list 36
- Access the Call log 46
- Activate/Deactivate handset loudspeaker mode 39
- Activate/Deactivate Remote Access 63
- Adjust earpiece or speaker volume 39
- Advanced settings 52
- Advanced Settings menu tree 31
- Answer a call 35
- Answer an external call during intercom 40
- Answer Machine menu tree 32
- Answering Machine Settings 63
- Auto Conference 53
- Auto hang-up 51
- Auto Prefix 57

B

- Backlight timing 51
- Base station 20
- Batteries 25

C

- Call Barring 53
- Call from redial list 33
- Call from the call log 34
- Call from the phonebook 34
- Call using Direct Access Memory 35
- Change PIN 54
- Change the Dial Mode 57
- Change the Display Language 49
- Change the Handset Name 48
- Charge battery 25

-
- Clock and Alarm menu tree 30
 - Clock and Alarm settings 42
 - Color themes 50
 - Connect the base station 23
 - Contrast 50

D

- Deactivate/Activate Auto Hang-Up 51
- Default PIN code 54
- Default settings 59
- Delete a call list entry 47
- Delete a phonebook entry 45
- Delete a redial number 37
- Delete all call list entries 48
- Delete all messages 61
- Delete all phonebook entries 45
- Delete all redial numbers 37
- Delete Direct Access Memory 46
- Dial mode 57
- Direct Access Memory 45
- Direct dialling 33
- Display icons and Messages 18
- Display languages 49

E

- Easy Call 52
- End a call 36
- Establish a three-party conference call 40

F

- Frequently asked questions 66
- Functions available during playback 61

G

- Getting started 23

H

- Handset menu structure 28
- Handset name 48
- Handset Screening 64
- Handsfree answering with handset 35

I

- Install battery 25
- Install your phone 25
- Intercom 39

K

- Key Beep 49
- Keypad lock/unlock 38

L

- Locate Handset 41

M

- Make a call 33
- Modify a phonebook entry 44
- Mute/Unmute microphone 39

N

- Network Service 59
- Network Services menu tree 32

O

- Overview of the base station 20
- Overview of your handset 15

P

- Personal settings 48
- Personal Settings menu tree 29
- Personalized message 62
- Phonebook menu tree 28
- PIN 54
- Play, Record, or Delete an Outgoing Message 62

- Playback of messages via handset 61
- Playing Messages 61
- Power requirements 6
- Predialling 33

R

- Registration 54
- Remote Access 63
- Reset Unit 56
- Ring Delay 63
- Ring Settings 48
- Ring tones 49
- Ring Volume 48

S

- Save a redial number 36
- Save call list entry 47
- Select phonebook melody 44
- Select the Color Theme 50
- Select the Display Wallpaper 50
- Set a Call Barring number 53
- Set Alarm 42
- Set Alarm Tone 43
- Set Auto Prefix 56
- Set Call Barring Mode 53
- Set Date and Time 42
- Set Date Format 42
- Set Easy Call number 52
- Set Easy Call to On or Off 52
- Set First Ring Detection 57
- Set the Answer mode 62
- Set the Backlight Time 51
- Set the Display Contrast 50
- Set the Ring Tones 49
- Set the Ring Volume 48
- Set Time Format 42
- Set Voice Mail Number 60
- Setting the Outgoing Message Language 65

Store a contact in the phonebook 43
Switch between an internal and external
call 40
Switch the handset off/on 38

T

Technical data 65
Telephone answering machine 60
Text or number entry 38
The call log 46
Transfer an external call 40
Turn the Answering Machine On/Off
from the Handset 62

U

Unregister 55
Using the Call log 46
Using the Intercom 39
Using the Redial list 36
Using your phone 33
Using your Phonebook 43

V

Voice Mail 59

W

Wallpaper images 50
What's in the box 14

X

XHD Sound 54

Y

Your phone 14



©2008 Koninklijke Philips Electronics N.V.

All rights reserved

Reproduction in whole or in part is prohibited without the written consent of the copyright owner

Document order number: 3111 285 47141 (US-EN)



Please Recycle
Printed in China